

**BAM 1020  
PARTICULATE MONITOR  
OPERATION MANUAL  
BAM 1020-9805 REV C**



**Met One Instruments, Inc.**

1600 NW Washington Blvd.  
Grants Pass, OR 97526  
Telephone: (541) 471-7111  
Facsimile: (541) 471-7116  
[www.metone.com](http://www.metone.com)

**BAM 1020 Particulate Monitor Operation Manual** - © Copyright 2020 Met One Instruments, Inc. All Rights Reserved worldwide. No part of this publication may be reproduced, transmitted, transcribed, stored in a retrieval system, or translated into any other language in any form without the express written permission of Met One Instruments, Inc.



# Table of Contents

<b>1</b>	<b>INTRODUCTION</b>	<b>5</b>
1.1	About This Manual .....	5
1.2	Technical Service.....	6
1.3	BAM: Beta Attenuation Monitor.....	6
1.4	Beta Radiation Safety Statement .....	7
1.5	BAM 1020 US-EPA Configurations.....	7
1.6	BAM 1020 Other Configurations .....	7
1.7	BAM 1020 Specifications .....	8
<b>2</b>	<b>SITE SELECTION AND INSTALLATION</b>	<b>9</b>
2.1	Unpacking, Inspection, and Evaluation Testing .....	9
2.2	Enclosure Selection and Temperature Control .....	9
2.3	Site Selection and Inlet Positioning Criteria .....	10
2.4	Mounting Options in a Walk-In Shelter.....	10
2.5	BAM 1020 Installation Instructions.....	11
2.6	BAM 1020 Power and Electrical Service.....	20
2.7	Configuring External Sensors .....	21
2.7.1	Configuring the BX-597A / BX-598 Sensor .....	21
2.7.2	Changing Sensor Addresses .....	21
<b>3</b>	<b>USER INTERFACE</b>	<b>23</b>
3.1	Main Operating Screen .....	24
3.2	Menu Hierarchy and Navigation.....	26
3.3	The OPERATE Menu.....	28
3.3.1	Load Filter Tape.....	28
3.3.2	Transfer Data .....	29
3.3.3	About .....	30
3.3.4	Conc Chart.....	30
3.4	The TEST Menu System – Overview.....	31
3.4.1	Leak Test .....	31
3.4.2	Ambient Temperature .....	32
3.4.3	Ambient Pressure .....	32
3.4.4	Flow Calibration .....	32
3.4.5	Self Test.....	33
3.4.6	Filter Sensors.....	33
3.4.7	Span Membrane .....	34
3.4.8	Tape Sensors.....	35
3.4.9	Inlet Heater .....	36
3.4.10	Beta Counter.....	36
3.4.11	Membrane Sensors.....	37
3.4.12	Nozzle Sensors.....	37
3.4.13	Digital Link .....	38
3.4.14	Relay Outputs .....	38
3.4.15	Analog Calibration.....	39

3.4.16	Analog Output .....	39
3.5	Setup Menu Description .....	40
3.5.1	Clock .....	41
3.5.2	Sample .....	41
3.5.3	Flow .....	42
3.5.4	Calibration .....	42
3.5.5	Inlet Heater .....	43
3.5.6	Units .....	44
3.5.7	Clear Memory .....	45
3.5.8	Password .....	45
3.5.9	Reports .....	46
3.5.10	Alarms .....	51
3.5.11	Station ID .....	52
3.5.12	Met Average .....	52
3.5.13	Analog Outputs .....	53
3.5.14	Serial Ports .....	53
3.5.15	Modbus .....	54
3.5.16	Ethernet .....	54
3.5.17	Ethernet Config .....	54
3.5.18	Sound Volume .....	55
3.5.19	Touch Calibration .....	55
3.5.20	Set Language .....	55
3.6	Alarms Menu .....	56
<b>4</b>	<b>INITIAL SETUP OF THE BAM 1020</b>	<b>57</b>
4.1	Power Up .....	57
4.2	Warm-up Period .....	57
4.3	The Main Operate Screen .....	57
4.4	Filter Tape Loading .....	58
4.5	Self-Test .....	59
4.6	Initial Setup Settings Considerations .....	60
4.7	Initial Leak Check and Flow Check .....	60
4.8	Starting a Measurement Cycle .....	60
<b>5</b>	<b>THE MEASUREMENT CYCLE</b>	<b>61</b>
5.1	The One-Hour Cycle Timeline .....	61
5.2	Automatic Span Checks During The Cycle .....	62
5.3	Filter Tape Use .....	63
<b>6</b>	<b>MAINTENANCE, DIAGNOSTICS and TROUBLESHOOTING</b>	<b>64</b>
6.1	Met One Recommended Periodic Maintenance Table .....	64
6.2	Filter Sensor Tests .....	65
6.2.1	Filter Temperature Sensor Tests .....	65
6.2.2	Filter Humidity Sensor Tests .....	66
6.2.3	Filter Pressure Sensor Tests .....	66
6.3	Flow System and Flow Calibrations .....	67
6.3.1	Flow System Diagram .....	67

6.3.2	Flow Control.....	67
6.3.3	Total Flow (Q <sub>TOT</sub> ) and Flow Rate (LPM) Conversions.....	67
6.3.4	About Leak Checks, Nozzle Cleaning, and Flow Checks .....	68
6.3.5	Leak Check Procedure .....	68
6.3.6	Nozzle and Vane Cleaning Procedure .....	73
6.3.7	Field Calibration of the Flow System.....	75
6.4	BAM 1020 Error and Alarm Descriptions .....	77
6.4.1	Alarm Relay .....	79
6.5	Comparison of BAM 1020 Data to Integrated Filter Sampler Data.....	80
6.6	Power Up Problems and Electrical Safety Considerations.....	81
6.7	Basic Problem and Cause/Solution Table.....	82
6.8	Nozzle Component Service and O-ring Replacement.....	85
6.9	Performing the 72-Hour Zero Filter Background Test .....	86
<b>7</b>	<b>DATA COLLECTION AND COMMUNICATIONS</b>	<b>88</b>
7.1	Back Panel Connections.....	88
7.2	External Data Logger Interface System .....	89
7.2.1	Analog Concentration Output Signal.....	89
7.2.2	Early Cycle Mode Option For Analog Data Collection.....	90
7.2.3	Interfacing a Digital Data logger with the BAM 1020.....	91
7.3	Digital Communications and Data Retrieval.....	92
7.3.1	Direct Serial Port Connections and Settings .....	92
7.3.2	Using Met One Comet Communications Software .....	93
7.3.3	Downloading Data Using Simple Terminal Programs .....	94
7.3.4	Help Menu and Command Descriptions Using a Terminal Program.....	95
7.3.5	Modem Option .....	100
7.3.6	BAM 1020 Firmware Upgrade.....	100
<b>8</b>	<b>ACCESSORIES and PARTS</b>	<b>101</b>
8.1	Consumables, Replacement Parts, and Accessories .....	101
<b>9</b>	<b>THEORY OF OPERATION</b>	<b>106</b>

# 1 INTRODUCTION

## 1.1 About This Manual

This document is organized with the most important information toward the front of the manual, such as site selection, installation, setups, and field calibrations.

Toward the back are sections that provide in-depth information on subjects such as theory, diagnostics, accessories, and alternate settings. These sections provide valuable information which should be consulted as needed. Electronic versions of this manual are also available.

This manual is periodically revised for maximum accuracy, and to incorporate new features or updates. Below is a brief description of the BAM 1020 manual revision history:

Rev	Released	Manual Description
A	2020-06-09	Initial release of BAM 1020 (83440)
B		<ol style="list-style-type: none"><li>1. Section 1.2: Update letter portion of the serial number description (Table 1-2).</li><li>2. Section 2.5: Added Transport Plate Figure 2.4.</li><li>3. Section 3.3.2: Added reference to Figure 2-4.</li><li>4. Section 3.4.7: Added text "is provided with" to paragraph beginning with "Each BAM 1020..."</li><li>5. Section 3.5.2: Spelling correction for "correspond."</li><li>6. Section 3.5.5: Added the case for 6% Low Power setting.</li><li>7. Section 8.1: Removed "standard accessory" text from BX-597A. Updated description and part numbers for BX-597A and BX-598 sensors.</li><li>8. Section 9.1: This section <i>Converting Data Between EPA Standard and Actual Conditions</i> was eliminated. This section is no longer needed because both Standard and Actual sample volumes and concentrations are calculated, displayed, reported, and stored in the data logger.</li></ol>

**Table 1-1 BAM 1020 Manual Change Summary**

## 1.2 Technical Service

Technical Service representatives are available during normal business hours of 7:00 a.m. to 4:00 p.m. Pacific Time, Monday through Friday. In addition, technical information and service bulletins are available from our website. Please contact us at the phone number or email address below to obtain a Return Authorization (RA) number before sending any equipment back to the factory.

Phone: **(541) 471-7111** Fax: (541) 471-7116

E-Mail: [service@metone.com](mailto:service@metone.com) Web: [www.metone.com](http://www.metone.com)

Address: Technical Services Department  
Met One Instruments, Inc.  
1600 NW Washington Blvd.  
Grants Pass, OR 97526

The BAM 1020 monitor has a serial number on the label on the back panel, embossed on the two metal NRC tags, and printed on the calibration certificate. This number is needed if contacting the technical service department to request information about repairs or updates for the BAM 1020. The serial number begins with a letter sequence which represents the year of manufacture, followed by a unique or five-digit number. Example: AN15878 was built in 2020.

Letter	Year	Letter	Year	Letter	Year
AN	2020	MN	2030	BN	2040
BN	2021	NN	2031	CN	2041
CN	2022	PN	2032	DN	2042
DN	2023	RN	2033	EN	2043
EN	2024	TN	2034	FN	2044
FN	2025	UN	2035	GN	2045
GN	2026	WN	2036	HN	2046
HN	2027	XN	2037	JN	2047
JN	2028	YN	2038	KN	2048
KN	2029	AN	2039	MN	2049

Table 1-2 Met One Instruments, Inc. Serial Number Designations by Year

## 1.3 BAM: *Beta Attenuation Monitor*

The Met One Instruments BAM 1020 beta attenuation mass monitor automatically measures and records ambient particulate mass concentration levels using the principle of beta ray attenuation. This method provides a simple determination of the ambient concentration of particulate matter in  $\text{mg}/\text{m}^3$  or  $\mu\text{g}/\text{m}^3$ . A small  $^{14}\text{C}$  (carbon 14) element inside of the BAM 1020 provides a constant source of beta rays. The beta rays traverse a path through which glass fiber filter tape is passed before being detected with a scintillation detector. At the beginning of the measurement cycle the beta ray count ( $I_0$ ) across clean filter tape is recorded. Then, an external pump pulls a known volume of PM-laden air through the filter tape thereby trapping the PM on the filter tape. At the end of the measurement cycle the beta ray count ( $I_3$ ) is re-measured across PM-laden filter tape. The ratio of  $I_0$  to  $I_3$  is used to determine the mass density of collected PM on the filter tape. A complete description of the measurement cycle is included in Section 5.1. In addition, a scientific explanation of the theory of operation and the related equations is included at the back of the manual.

## **1.4 Beta Radiation Safety Statement**

The Met One Instruments BAM 1020 contains a small  $^{14}\text{C}$  (carbon 14) beta radiation-emitting source. The activity of the source is  $60 \mu\text{Ci} \pm 15 \mu\text{Ci}$  (microcuries), which is below the “Exempt Concentration Limit” of  $100 \mu\text{Ci}$  as determined by the United States Nuclear Regulatory Commission (US-NRC). The owner or operator of the BAM 1020 is not required to have a license to possess or operate the equipment under US-NRC regulations. The owner may however elect to return the monitor to Met One Instruments for recycling of the  $^{14}\text{C}$  source when the monitor has reached the end of its service life, although is under no obligation to do so. Under no circumstances should anyone but factory technicians attempt to remove or access the  $^{14}\text{C}$  source.  $^{14}\text{C}$  has a half-life of about 5730 years and should never need to be replaced. Neither the  $^{14}\text{C}$  source nor the detector are serviceable in the field. Should these components require repair or replacement, the BAM 1020 must be returned to the factory for service and recalibration.

## **1.5 BAM 1020 US-EPA Configurations**

The BAM 1020 is US-EPA designated for  $\text{PM}_{10}$ ,  $\text{PM}_{2.5}$  and  $\text{PM}_{10-2.5}$  under the following designation numbers:

- Designation Number: EQPM-0798-122 ( $\text{PM}_{10}$ )
- Designation Number: EQPM-0308-170 ( $\text{PM}_{2.5}$  with BGI/Mesa Labs VSCC™ or Tisch Cyclone)
- Designation Number: EQPM-0715-266 ( $\text{PM}_{2.5}$  with URG Cyclone)
- Designation Number: EQPM-0709-185 ( $\text{PM}_{10-2.5}$  with BGI/Mesa Labs Cyclones)

US-EPA designated methods using the BAM 1020 are modified from time to time in order to reflect hardware or software improvements. These modifications do not impact previously designated configurations of the BAM 1020 but may provide the end user with a product upgrade path that will allow the monitor to continue to be operated as a US-EPA designated method. For further details, please contact our service department. Details concerning US-EPA designated configurations of the BAM 1020 may be found on the US-EPA website:

<https://www.epa.gov/amtic/air-monitoring-methods-criteria-pollutants>

## **1.6 BAM 1020 Other Configurations**

The BAM 1020 is used worldwide. Although many international jurisdictions use the US-EPA configurations, others do not. Consult with the appropriate local monitoring authority for details on how the BAM 1020 should be configured and operated locally.



## 1.7 BAM 1020 Specifications

PARAMETER	SPECIFICATION
Measurement Principle	Particulate Concentration by Beta Attenuation.
U.S. EPA Designations	PM <sub>10</sub> : EQPM-0798-122 PM <sub>2.5</sub> EQPM-0308-170 PM <sub>2.5</sub> EQPM-0715-266 PM <sub>10-2.5</sub> EQPM-0709-185
Standard Range	0 - 10.000 mg/m <sup>3</sup> (0 – 10,000 µg/m <sup>3</sup> )
Accuracy	Exceeds US-EPA Class III PM <sub>2.5</sub> FEM standards for additive and multiplicative bias
Lower Detection Limit	< 4.8 µg/m <sup>3</sup> (2σ) (1 hour) (< 4.0 µg/m <sup>3</sup> typical) (8-minute count time)
Lower Detection Limit	< 1.0 µg/m <sup>3</sup> (2σ) (24 hour)
Measurement Cycle Time	1 hour
Flow Rate	16.67 liters/minute
Filter Tape	Glass fiber filter
Span Check	Nominally 800 µg/cm <sup>2</sup>
Beta Source	C-14 (carbon-14), 60 µCi ±15 µCi (< 2.22 X 10 <sup>6</sup> Beq), Half-Life 5730 years
Beta Detector Type	Photomultiplier tube with scintillator
Operating Temp. Range	0° to +50°C
Ambient Humidity Range	0 to 90% RH, non-condensing
Humidity Control	Actively controlled inlet heater module
Approvals	U.S. EPA, MCERTS, CE, NRC, TUV, CARB, ISO 001
Standard User Interface	4.3" graphic color touch screen display
Analog Output	Two channels; 0-1, 0-2.5, 0-5 VDC
Serial Interface	One (1) full duplex RS-232, one (1) half duplex RS-485 serial port for PC or modem communications One (1) USB Type B serial port One (1) Ethernet port Two (2) RS-485 serial ports for sensor network
Alarm Contact Closure	1 channel; dry NO contact; 1 A at 125 VAC or 60 VDC maximum.
Compatible Software	Air Plus™, Comet™, HyperTerminal®
Error Reporting	User-configurable. Available through serial port, display, and relay outputs
Memory	14,000 records (1.5 Years @ 1 record/hr)
Power Supply	100-240 VAC 50/60 Hz universal input; 12 VDC, 8.5 A output
Power Consumption	Unit: 12W; Heater: 100W/175W; Medo Pump 150W; GAST Pump 530W
Weight	19 kg (42 lbs) without external accessories
Unit Dimensions	H x W x D = 36.2cm x 48.3cm x 46.7cm (14.25" x 19" x 18").

Specifications may be subject to change without notice.

## 2 SITE SELECTION AND INSTALLATION

### 2.1 Unpacking, Inspection, and Evaluation Testing

If any damage to the shipment is noticed before unpacking, **a claim must be filed with the commercial carrier immediately**. Notify Met One Instruments after notification of the commercial carrier.

Unpack the BAM 1020 and accessories and compare them to the packing list to make sure all of the required items are included for the type of installation planned. A separate quick setup guide with color photos of most of the common accessories will be included with this manual. Operators can use the quick setup guide to fully configure and operate the BAM 1020 on a test bench if desired.

The BAM 1020 is shipped with one or two white foam rings and a white plastic shim inside the front of the BAM 1020, which prevent the moving parts of the tape control assembly from being damaged during transit. The rings and shim should be replaced when the BAM 1020 is being transported in order to avoid damaging the tape control mechanism. Do not ship or transport the BAM 1020 with filter tape installed. Met One Instruments, Inc. recommends keeping the special shipping box and foam packing material which the BAM 1020 came in as they could be re-used if the BAM 1020 needs to be transported to another site or returned to the factory for any reason.

### 2.2 Enclosure Selection and Temperature Control

The BAM 1020 monitor is not weatherproof. It is designed to be mounted in a weatherproof, level, low vibration, dust free, and temperature-stable environment where the operating temperature is between 0° C and +50° C, and where the relative humidity is non-condensing and does not exceed 90%. There are two standard configurations described below for providing a weatherproof location in which to install the BAM 1020. Please contact Met One Instruments, Inc. for advice if there is a need to use a non-standard mounting or enclosure configuration.

1. **A walk-in shelter or building:** These are usually semi-portable pre-fabricated shelters or portable trailers with a flat roof, or a room in a permanent building or structure. The BAM 1020 may be placed on a workbench or mounted in an equipment rack. The inlet tube of the BAM must extend up through a hole in the roof of the structure with appropriate sealing hardware. AC power must be available. Instructions for this type of installation are included in this section of this manual.
2. **BX-902/903/906 mini weatherproof enclosures:** these small pre-fabricated enclosures are just big enough for the BAM and related accessories and are installed on the ground or on the roof of a larger building. They are available with a heater (BX-902), or with a heater and air conditioner (BX-903). A dual-unit air conditioned mini shelter is also available (BX-906). These enclosures are all specified by Met One to accept the BAM 1020, and are supplied with a supplemental installation manual.

**Shelter Temperature Control Notes:** The air temperature inside a BAM shelter or enclosure is not required to be regulated to any specific narrow range or set point (such as 25 °C), subject to the following caveats:

1. The shelter temperature must stay between 0 and 50 °C inside at all times or alarms and failures may result. Remember that the vacuum pump and inlet heater can contribute significantly to shelter heating.
2. The exact shelter temperature within the 0-50 °C range is not critical. However, temperature changes during the measurement cycle can lead to measurement artifacts. These artifacts, when present tend to present only during hourly measurements and are generally insignificant when daily averages are calculated.
3. BAM 1020 users in hot climates where the ambient temperature exceeds 40 °C should consider using the model BX-903 air conditioned mini shelter or an air conditioned walk-in shelter to avoid over-heating the BAM 1020.
4. The portion of the inlet tube inside of the shelter or building should always be adequately insulated. This is especially important when the equipment is operated under conditions of high ambient dew point. Otherwise condensation could occur inside the sampling tube and/or measurement artifacts could result. If this proves to be an issue, the user may consider increasing the temperature inside the shelter to a point closer to ambient temperature. The BAM 1020 should not be placed directly in the path on an air conditioning vent.

### **2.3 Site Selection and Inlet Positioning Criteria**

Met One Instruments, Inc. recommends checking for local regulations and guidance documentation that may exist before selecting the site in which to install the BAM 1020. For example, US-EPA provides a variety guidance documents where site selection issues are addressed. Such guidance and regulation may provide information concerning:

1. Inlet height
2. Spacing and clearance
3. Proximity to particulate sources, both mobile and stationary
4. Additional siting criteria or considerations

These details should be understood before selecting a site.

### **2.4 Mounting Options in a Walk-In Shelter**

When the BAM 1020 is to be located in a walk-in shelter, it may be installed in either an equipment rack or on a bench top. Take the following into account when planning the mounting:

- **Rear Access:** It is important to leave plenty of access to the rear of the BAM 1020 for wiring connections and maintenance. At least five inches is required. Full access to the back is recommended whenever possible. There must be adequate access to the power switch located on the back of the instrument.
- **Top Access:** It is necessary to have a minimum of eight inches clearance between the top of the BAM 1020 inlet receiver and the bottom of the shelter ceiling to accommodate the smart inlet heater.
- **Mobile Shelters:** If the BAM 1020 is being installed into an equipment rack in a mobile trailer or van, then additional care should be taken to ensure that the mounting can handle the additional strain. The foam shipping rings must also be inserted any time a mobile shelter is moved with the BAM 1020 inside.

- **Rack Modifications:** It is usually necessary to modify the top plate of the equipment rack by cutting a 2 inch diameter (75mm) hole to allow the inlet tube to extend through to the ceiling. The BAM 1020 dimensional drawings below show the location of the inlet. *Note:* The inlet heater installs onto the inlet tube two inches above the top of the inlet receiver of the BAM 1020. If the BAM 1020 is to be mounted in a rack, it will be necessary to leave extra room above the BAM 1020 in the rack for the heater, or to make the hole in the top of the rack larger in order to clear the heater diameter. The heater is supplied with a foam insulation sleeve which may be modified as needed. Make sure these parts are going to fit before installing the BAM 1020.

## 2.5 BAM 1020 Installation Instructions

When installing the BAM 1020 into a shelter or structure the following issues should be taken into consideration.

1. **Roof Modifications:** Determine the exact location where the BAM inlet tube will pass through the roof of the shelter and drill a 2 ¼" or 2 ½" (60mm) diameter hole through the roof at that location. Make sure the hole is directly above where the inlet receiver is to be located, so the inlet tube will be perfectly vertical. A plumb weight is useful for determining where to locate the hole. Note that the inlet receiver on the BAM 1020 is slightly off-center! BX-902/903 mini shelters do not require any roof drilling.
2. **Waterproof Roof Flange:** Apply all-weather silicone caulking around the top of the hole and install the BX-801 roof flange onto the hole. The threaded barrel of the flange is usually installed downward. Secure the flange in place with four lag bolts or self-tapping screws (not supplied). Caulk around the screws to prevent leaks. Apply Teflon tape to the threads of the gray plastic watertight fitting and screw it into the roof flange tightly. BX-902/903 mini shelters come with a roof flange installed, and only need the watertight fitting. **Note:** Some users prefer to fabricate their own roof flange instead of using the one supplied by Met One Instruments, due to factors such as high snow loading or a sloped roof. Equipment damage from a leaking roof is not covered under warranty.
3. **Inlet Tube Installation and Alignment:** Remove the threaded cap and rubber seal from the watertight inlet tube seal assembly. This makes it easier to install the inlet tube since the rubber seal is a tight fit. Lower the inlet tube through the flange assembly and into the inlet receiver on the BAM 1020, making sure that the inlet tube is fully seated. It is very important for the inlet tube to be perpendicular to the top of the BAM 1020. The nozzle may bind if the inlet is misaligned. A simple check is to rotate the inlet tube back and forth by hand before tightening the roof flange seal or the BAM 1020 inlet set screws. If the inlet tube is straight, then the tube should rotate fairly easily while inserted into the BAM 1020. If it does not rotate, check the inlet tube for vertical alignment or move the BAM 1020 slightly.

**It is always recommended that the exposed portion of the inlet tube inside the shelter be insulated.**

4. **Smart Inlet Heater Installation:** Before tightening the inlet tube in place, the BX-827 or BX-830 smart inlet heater (used on most BAM 1020 monitors) must be installed onto the tube. Lift the inlet tube out of the top of the BAM 1020, and pass the tube through the hole in the heater body (the cable end is the bottom). Then re-insert the inlet tube into the BAM. Position the bottom of the smart heater unit **two inches** above the top of the inlet receiver on the BAM, and securely tighten the two set screws in the heater to fasten it to the tube.

Included with the smart heater is a 12" tube of white insulation. The tube is split down its length for easy application. Wrap the insulation around the heater body and peel back the adhesive cover strip to secure in place. The insulation may be cut to fit if needed. The insulation sleeve provides more consistent heating, and prevents items from coming into contact with the hot heater body.

5. **Smart Heater Electrical Connections:** All generations of the BX-827/830 Smart Heater have the same 3-pin metal power connector. The Smart Heater connector plugs into the 3-pin connection of the external heater relay enclosure mounted on the back panel. An A/C power cord connects to the relay enclosure via a power entry module. The relay located inside the heater relay enclosure is controlled by the 12VDC heater control signal.

 *Warning! The heater relay controls live AC line voltage to the 3-pin socket. Treat the 3-pin socket like a live power outlet whenever power is applied. Do not open or service the heater relay enclosure or heater module when power is applied.*

 *Warning! The Smart Heater has triple redundant safety features to prevent overheating, but the heater surface temperature can exceed 70 degrees C during high humidity conditions. Use the white insulation sleeve to prevent contact with the heater during operation.*

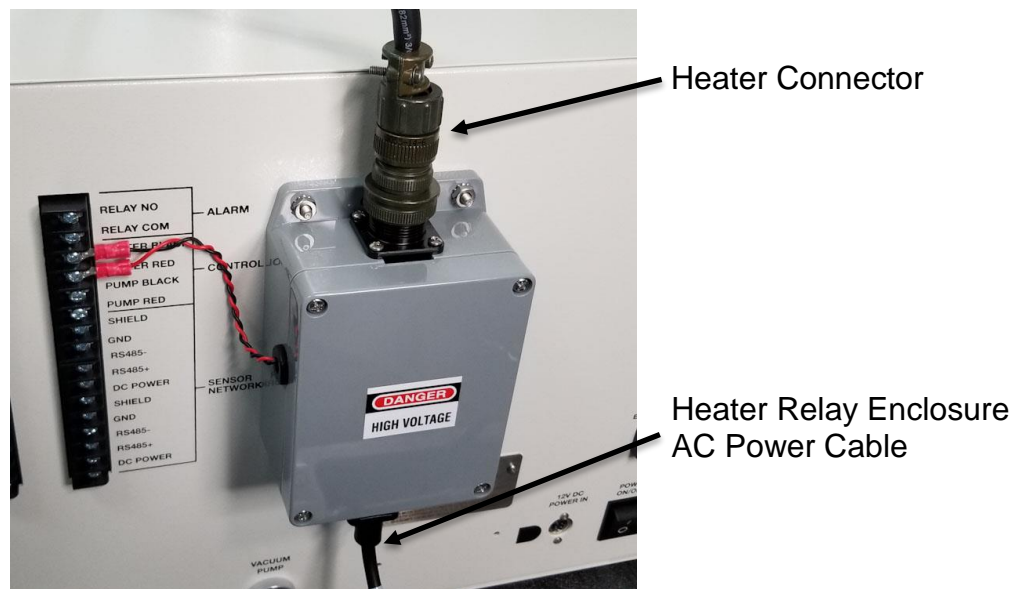

**Smart Heater Back Panel Connection**

6. **Tightening the Inlet:** After the inlet tube is aligned and the heater installed, slide the black rubber seal and cap down over the top of the inlet tube and into the roof flange. It is easier if the rubber seal is wetted with water first. Tighten the plastic cap. Tighten the two set screws in the top of the BAM 1020 inlet receiver.

7. **Inlet Support Struts:** The BX-801 inlet kit comes with two angled aluminum struts to support the inlet tube above the roof and prevent the inlet from moving in the wind. These struts are typically fastened (about 90 degrees apart) to the inlet tube with a supplied hose clamp. The bottom ends of the struts should be fastened to the roof with lag bolts (not supplied). Some installations may require different methods or hardware for supporting the inlet tube. Support the tube in the best manner available. The BX-902/903 mini shelters do not require inlet tube supports.
8. **Temperature Sensor Installation:** BAM 1020 units are supplied with a BX-598 (AT) or BX-597A (AT/BP/RH) sensor, which attaches to the inlet tube above the roof. The sensor cable must route into the shelter to be attached to the BAM. Use a waterproof cable entry point or weatherhead if the shelter has one. The BX-902/903 mini shelters have a cable entry on the side. Route the cable into the shelter in the best manner available. In some cases, it may be necessary to simply drill a 3/8" hole through the roof a few inches away from the inlet tube, route the cable through the hole and caulk it to prevent leaks. The BX-597A sensor attaches directly to the inlet tube with a supplied U-bolt.

Connect the cable to the Sensor Network on the back panel of the BAM 1020 as follows.

BX-597A Temp/RH/Pressure Sensor		BX-598 Temp Sensor	
Terminal Block	Cable Wire Color	Terminal Block	Cable Wire Color
Shield	White/Brown	Shield	White/Brown
Gnd	Black	Gnd	Black
RS485 -	White	RS485 -	White
RS485 +	Orange	RS485 +	Orange
DC Power	Red	DC Power	Red

9. **Wind Sensors:** The AIO 2 or MOS-485 wind sensors may also be connected to the Sensor Network. These sensors must be configured with address 2 in conjunction with a BX-597A or BX-598 temperature sensor (See section 2.7). Wind sensors must be mounted to avoid any possible wind obstructions caused by the BAM inlet components. Reference sensor manuals for mounting options.

AIO 2 Sensor		MSO-485 Sensor	
Terminal Block	Cable Wire Color	Terminal Block	Cable Wire Color
Shield	White/Brown	Shield	White/Brown
Gnd	Black & Green	Gnd	Black & Green
RS485 -	Grey	RS485 -	Brown
RS485 +	Yellow	RS485 +	White
DC Power	Red	DC Power	Red

10. **Inlet Separator Heads:** For PM<sub>10</sub> monitoring, the BX-802 Size-Selective Inlet is installed directly onto the inlet tube with no cyclone. To configure the BAM 1020 for PM<sub>2.5</sub> monitoring, install the PM<sub>2.5</sub> size fractionator below the PM<sub>10</sub> head as shown below. Use O-ring lubricant as needed. Met One Instruments offers a variety of PM<sub>2.5</sub> fractionators for use with the BAM 1020.
11. **Inlet Tube Grounding:** The two ¼”-20 set screws located in the inlet receiver of the BAM should create a ground connection for the inlet tube to prevent static electricity from building up on the inlet tube under certain atmospheric conditions. This is also important in areas near electromagnetic fields, high voltage power lines, or RF antennas. Check the connection by scraping away a small spot of the clear anodizing near the bottom of the inlet tube and use a multimeter to measure the resistance between this spot and the “CHASSIS” ground connection on the back of the BAM 1020. It should measure only a couple of Ohms or less if a good connection is made with the set screws. If not, remove the set screws and run a ¼-20 tap through the holes. Then reinstall the screws and check the electrical resistance again. **Note:** Anodized aluminum surfaces are non-conductive.
12. **Pump Location and Installation:** The best location for the vacuum pump is often on the floor under the rack or bench, but it may be located up to 25 feet away if desired. It may be preferable to locate the pump so that noise is minimized if the BAM 1020 is in an area where personnel are present. If the pump is to be enclosed, ensure that it will not overheat. The Gast pumps have a thermal shutdown inside which may trip if overheating occurs. Route the clear 10 mm air tubing from the pump to the back of the BAM 1020, and insert it firmly into the compression fittings on both ends. The tubing should be cut to the proper length and the excess tubing saved.

The pump is supplied with a 2-conductor signal cable which the BAM 1020 uses to turn the pump on and off. Connect this cable to the terminals on the back of the BAM 1020 marked “CONTROL.” The end of the cable with the black ferrite filter goes toward the BAM. Connect the Black wire to the “Pump Black” terminal and the Red wire to the “Pump Red” terminal. Connect the other end of the cable to the two terminals on the pump.

There are two pump types available for the BAM 1020. The Gast rotary vane pumps are louder and draw considerably more power than the Medo linear piston pumps, but have better vacuum capacity, especially at higher altitude or in 50 Hz applications. The Medo pumps are smaller, quieter, and more efficient, but aren’t recommended for 50 Hz use.

13. **Optional Connections:** Newer data loggers often interface to the BAM 1020 using the digital serial ports for better accuracy. Information about this is also found in Section 7. Met One can also supply additional technical bulletins on the subject.

The BAM 1020 has a variety of other connections: Alarm relay, analog outputs, Ethernet and serial port connections located on the back as shown in Figure 2-5 below. These items are described in Section 7 of this manual.

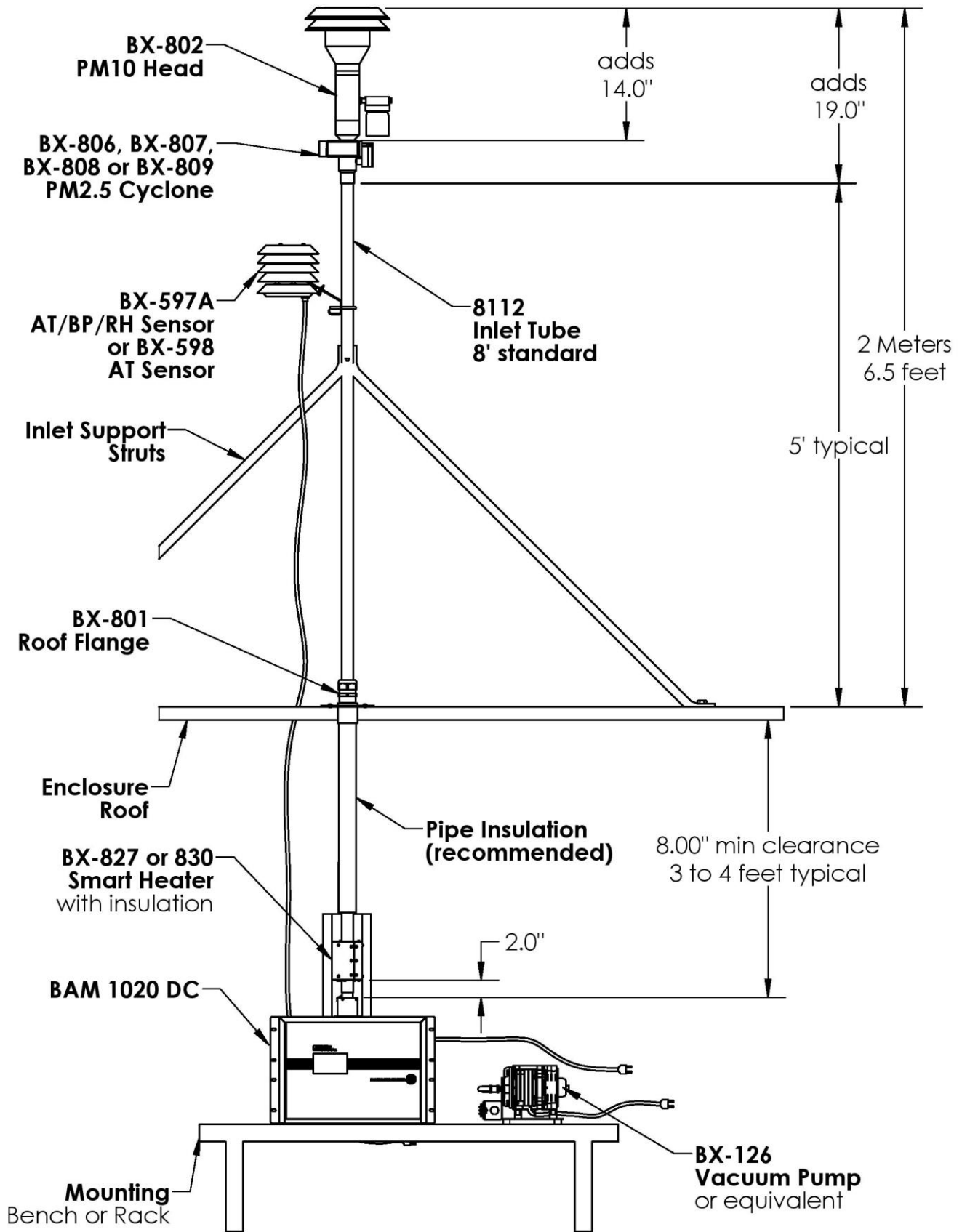
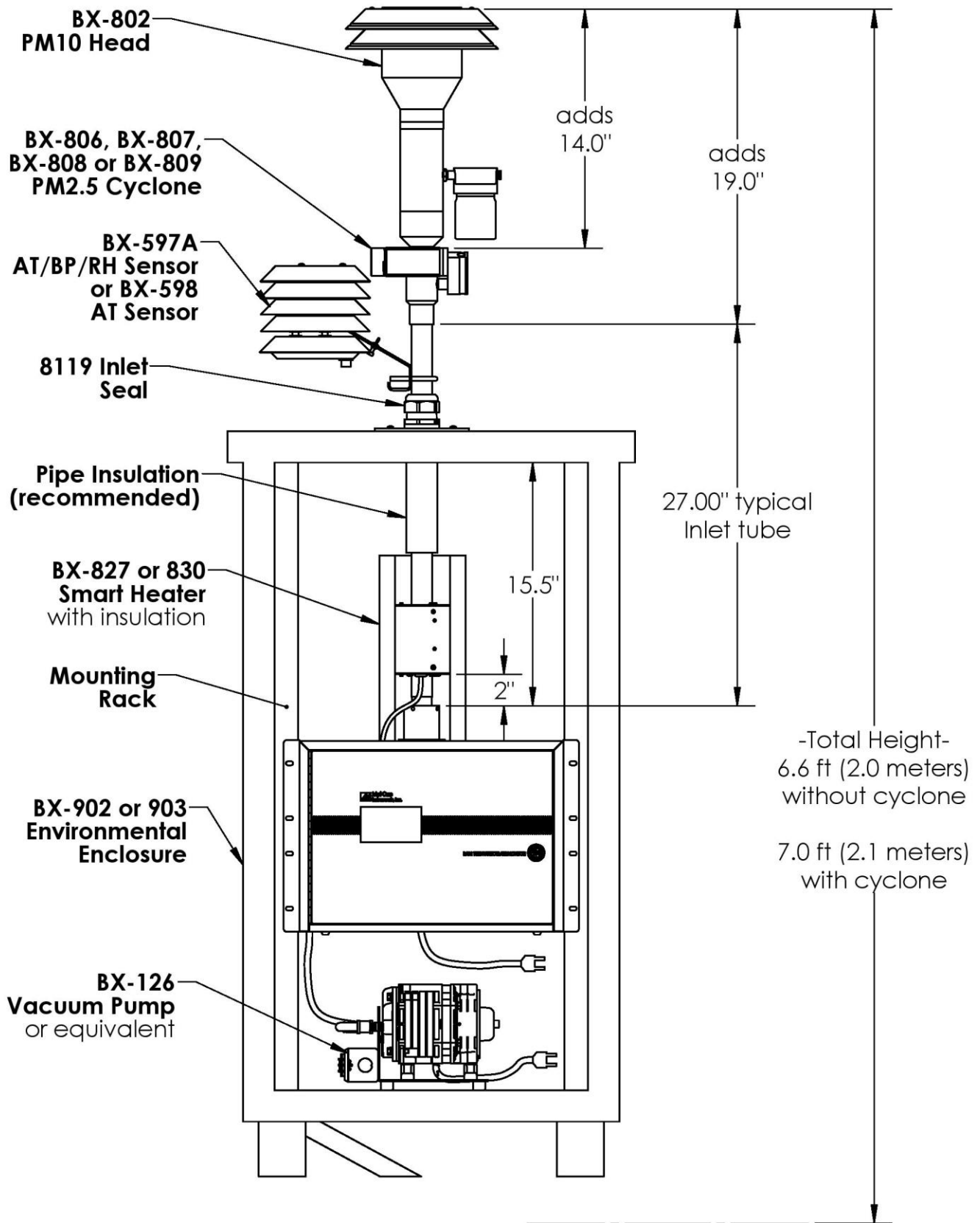

Figure 2-1 Typical BAM 1020 Installation in a Walk-in Shelter





**Figure 2-2 Typical BAM 1020 Installation in a BX-902 Mini Enclosure**

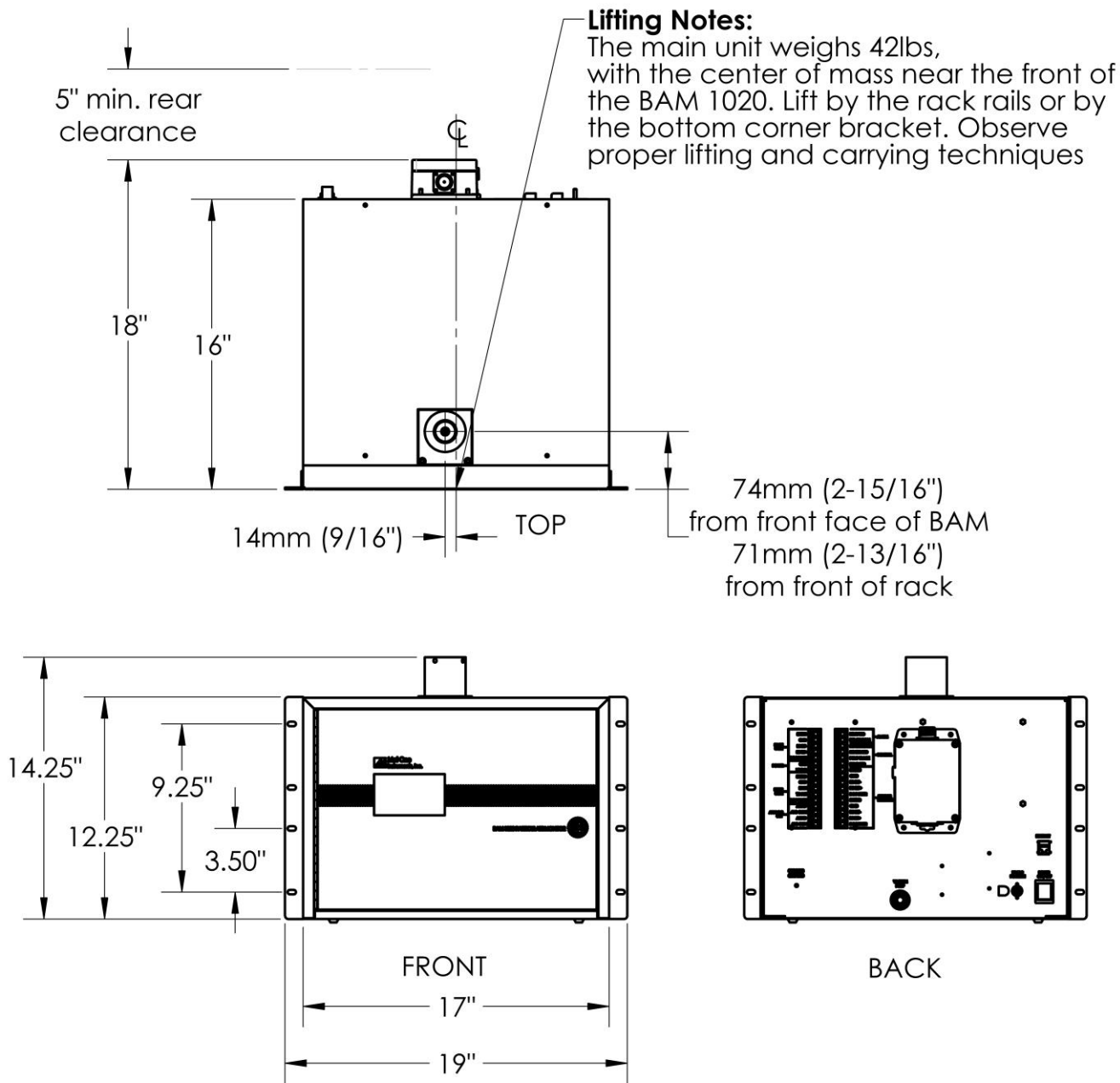
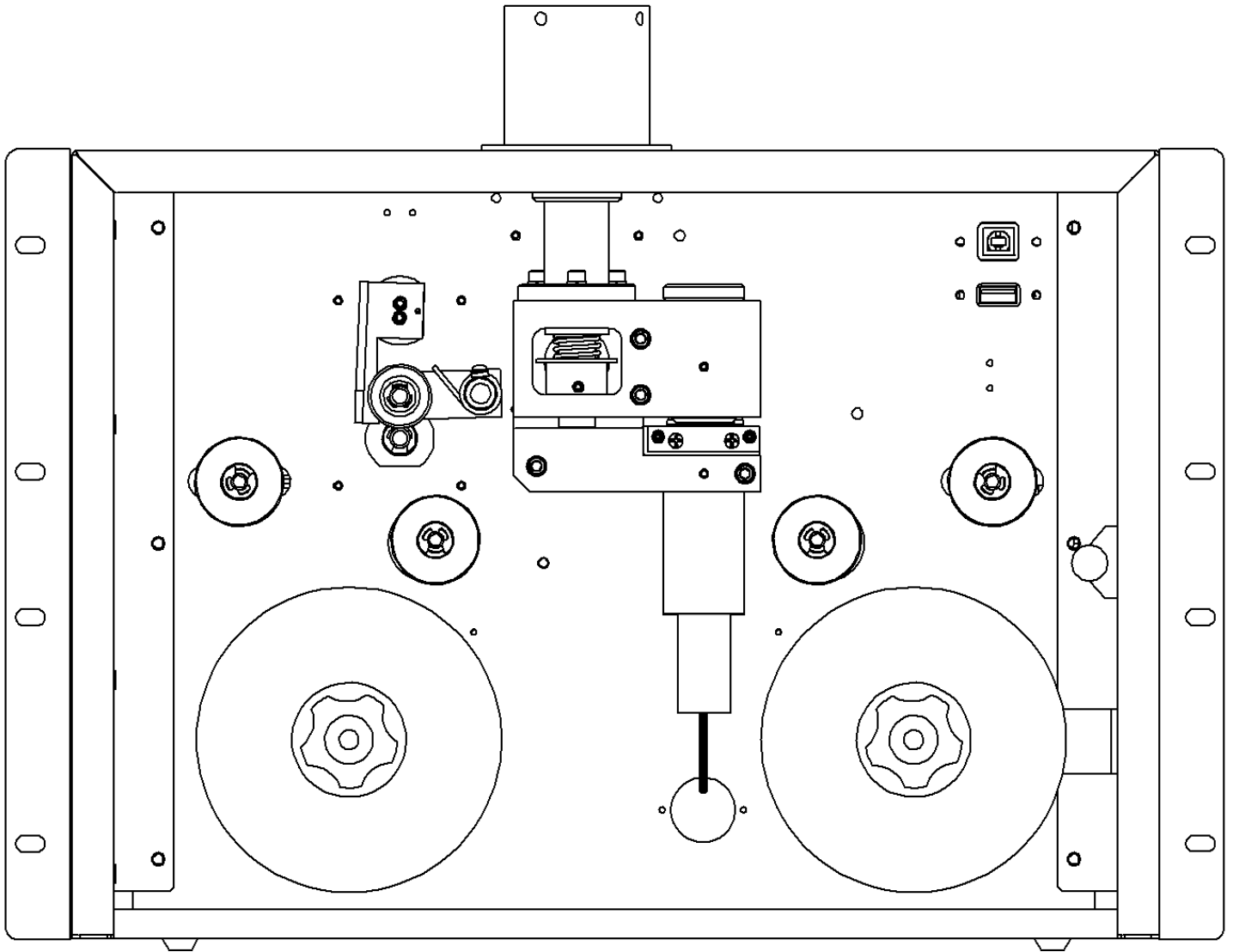

Figure 2-3 BAM 1020 Mounting Dimensions



**Figure 2-4 BAM 1020 Transport Plate**

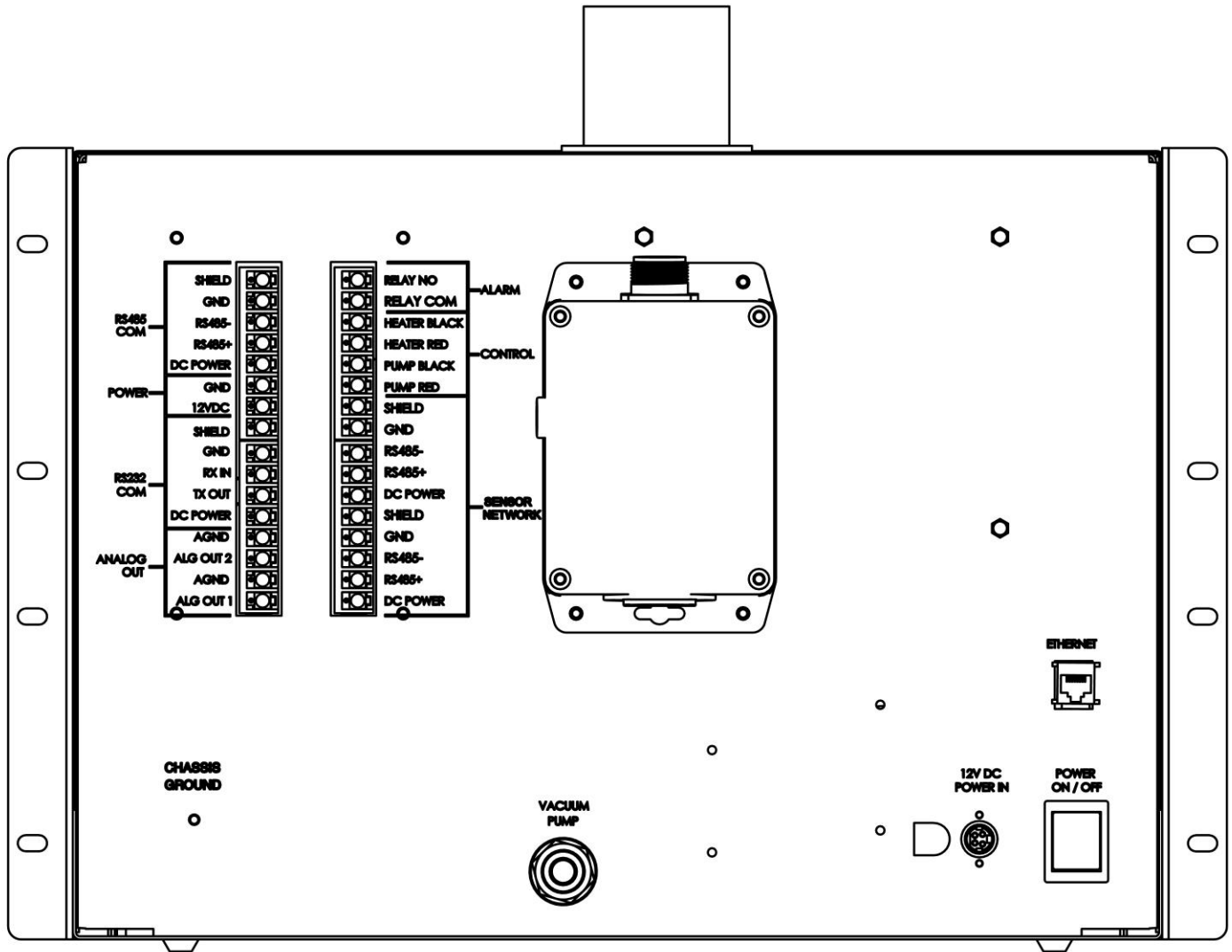

Figure 2-5 BAM 1020 Rear Panel Connections

## 2.6 BAM 1020 Power and Electrical Service

The BAM 1020 uses internal 12VDC motors for the tape control system. The external 12VDC power supply accepts **100-240VAC at 50-60Hz**. The external vacuum pump and inlet heater are AC powered and voltage-specific. Note: The vacuum pump power cord is hardwired and may need to be replaced or adapted to match local outlet types outside of North America.



*Warning: The shelter and/or electrical service must be wired for the correct voltage and frequency in accordance with local electrical codes. Running the vacuum pump or inlet heater on incorrect line voltage or frequency will cause improper operation.*

The current draw of the system varies considerably depending on optional accessories and environmental conditions. A dedicated 15 Amp electrical circuit is generally adequate to run a single complete BAM 1020 system, unless a large air conditioner is on the same circuit. Consult a qualified electrician if unsure. A summary of some worst-case loads is given below:

Model	Description	Amps	Wattage
<b>BAM 1020</b>	BAM 1020 only, 120V, worst case with tape transport motors running.	1.02A	12W
<b>BX-126</b>	Medo Linear Piston Pump, 120V, 60Hz, at 16.67 L/min through clean tape.	1.25A	150W
<b>BX-121</b>	Gast Rotary Vane Pump, 120V, 60Hz, at 16.67 L/min through clean tape.	4.44A	530W
<b>BX-122</b>	Gast Rotary Vane Pump, 230V, 50Hz, at 16.67 L/min through clean tape.	2.30A	530W
<b>BX-827</b>	Smart Inlet Heater, 120V, 60Hz, running at 100% high RH duty cycle.	0.85A	100W
<b>BX-830</b>	Smart Inlet Heater, 230V, 50Hz, running at 100% high RH duty cycle.	0.76A	175W
<b>BX-902B</b>	Shelter One Mini Shelter, 120V, worst case with shelter heater ON	4.2A	500W
<b>BX-903</b>	Ekto Mini Shelter, 120V, 2000 BTU air conditioner.	7.4A	586W
<b>BX-904/906</b>	Ekto Mini Shelter, 120V, 4000 BTU air conditioner.	13.5A	1172W

**Table 2-1 BAM 1020 Power Requirements**

### Notes:

- The BAM transport motors only run for a few seconds each per hour. Quiescent BAM current is 760mA.
- The vacuum pump runs for either 42 or 50 minutes per hour. Startup inrush current is higher.
- Smart Heater wattage drops to idle at 20% (120V) or 6% (230V) when filter RH is below 35%.
- The BX-902B shelter heater is usually off whenever shelter temp is over 40 degrees F and can be disabled.
- Values are based on measurements or best available information. Additional information is available from Service.

**Fuse:** There is one 5x20mm, 2.0A, 250V SLO BLO fuse in an inline fuse holder located inside the BAM 1020 near the power switch. It can be accessed by removing the BAM 1020 enclosure cover.

**Power Outages and Battery Backup:** Any momentary AC power outages will reset the BAM 1020 CPU and prevent data collection for the sample hour. The BAM 1020 may be plugged into a PC-style uninterruptible power supply (UPS) battery back-up unit to prevent this. A UPS of at least 300 Watts is usually sufficient. The vacuum pump does not need to be connected to the UPS, because the BAM 1020 can compensate for short pump flow outages of less than 1 minute duration. If the pump is to be backed up, then a much larger UPS wattage is required.

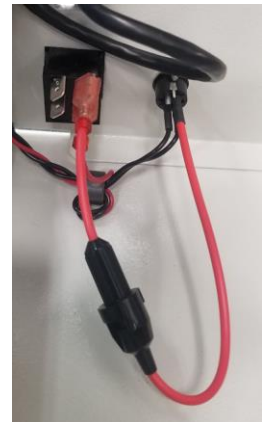

**Chassis Ground:** Connect the ground marked “CHASSIS GROUND” on the back of the BAM 1020 to an earth ground point using the green/yellow ground wire supplied with the BAM 1020. A copper earth-ground rod is recommended. The chassis ground is primarily for added RFI/EMI noise immunity. The power cord also uses the standard electrical safety ground.

## 2.7 Configuring External Sensors

The BAM 1020 must have a BX-597A or BX-598 sensor connected and properly configured for operation. If the sensor is not present, the BAM 1020 will not begin sampling.

### 2.7.1 Configuring the BX-597A / BX-598 Sensor

The BAM 1020 requires the sensor at address 1 of its serial network to begin sampling. Once the physical connections are made (see section 2.5), the sensor is programmed using the Digital Link screen located in the Test Menu 2 (see section 3.5).

Upon entering the Digital Link screen, any digital sensor connected to the BAM 1020 with address 1 or 2 will appear in either the Sensor 1 or Sensor 2 fields, as appropriate. In addition to the sensor type, the address fields on this screen also display the firmware currently installed in the sensor. This screen (right) shows a two sensor configuration.

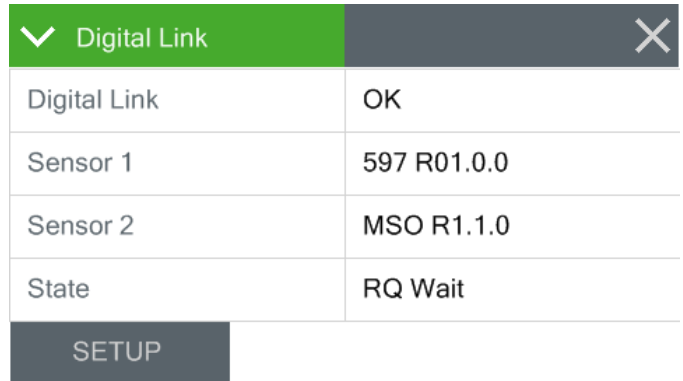

Digital Link	
Digital Link	OK
Sensor 1	597 R01.0.0
Sensor 2	MSO R1.1.0
State	RQ Wait
SETUP	

Figure 2-6 Digital Link Screen

The State field indicates that the BAM 1020 is either starting up digital communications or waiting for a response from the sensor. If firmware revision is missing or incorrect, communications are not properly established with the sensor. The SETUP button provides access to the Digital Setup screen for configuring the addresses of the digital sensors. See section 2.7.2 for details.

### 2.7.2 Changing Sensor Addresses

The default address for most digital sensors provided by Met One Instruments, Inc. is to set the address to 1.

If a connected sensor has an address other than 1 or 2, it can be located in the Digital Setup screen by pressing the SCAN button. The digital sensor network will scan through all potential network address nodes in an attempt to locate any connected devices. Progress of this scan can be seen in the third address field label (which displays Addr 3, by default) and the word “Scanning” will appear in the field itself.

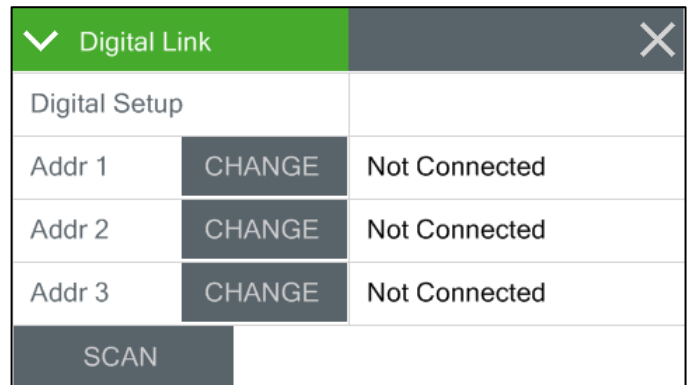

Digital Link	
Digital Setup	
Addr 1	CHANGE Not Connected
Addr 2	CHANGE Not Connected
Addr 3	CHANGE Not Connected
SCAN	

Figure 2-7 Scanning for Sensors

If a device is located at some other address, it can be changed by pressing CHANGE button next to the third address field. In the example shown to the right here, the BX-597A has been configured for address 14. Pressing the SET 1 button will update the address in the sensor to address number 1 and exit back to the main Digital Link screen. The Sensor 1 field will now display the BX-597A details similar to the image in section 2.7.1.

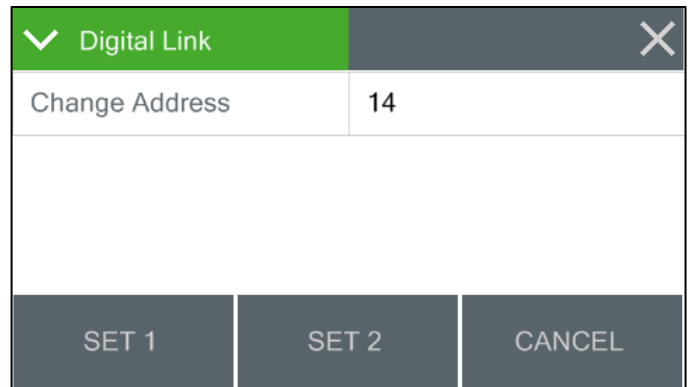

**Figure 2-8 Change Address**

If two sensors share the same address, disconnect one of them and then use the CHANGE button to set the other one to a different address. Remember that the BX-597A / BX-598 must be configured for address number 1 and if an optional wind sensor is connected, it will need to be set to number 2.

### 3 USER INTERFACE

This section describes the BAM 1020 user interface system, and explains the functions of the main menu options, including how to view data and errors.



**Figure 3-1 The BAM 1020 User Interface**

The BAM 1020 user interface is a touchscreen display used to control almost all of the features and functionality of the BAM 1020. It is mounted on the back side of the front door assembly with access to the display granted through a cutout on the door panel as shown in Figure 3-1.



### 3.1 Main Operating Screen

In addition to the last hourly concentration reading, this screen shows the current real-time values being measured and the operational state of the BAM 1020. The upper left image in Figure 3-2 is the screen that will normally be displayed.

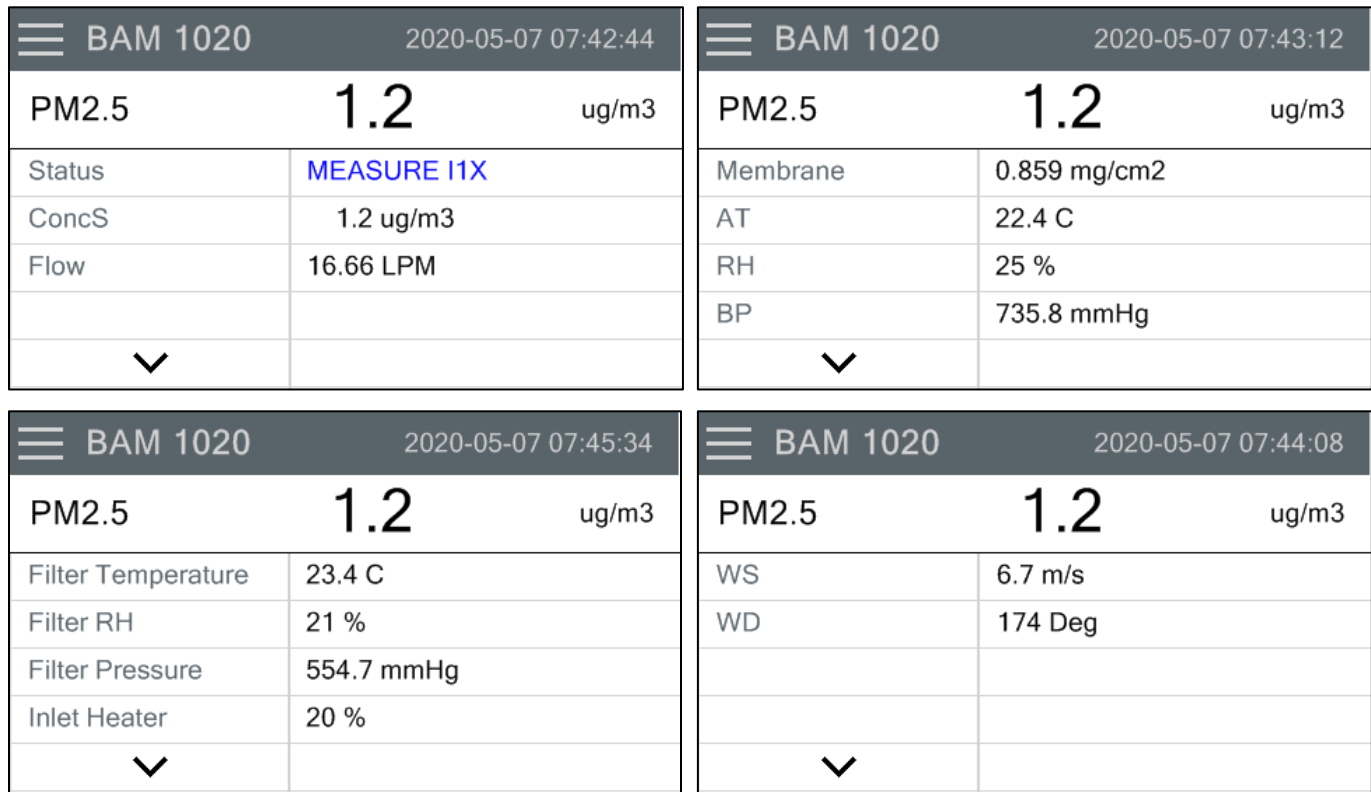

Figure 3-2 The BAM 1020 Main Operating Screens

Note that the display has a limited amount of space and cannot show all of the real time data on one screen. Tap down arrow key in the lower left corner of the display to navigate between the four screens shown in Figure 3-2.

**Note:** A concentration value of 99.999 mg/m3 or 99999 ug/m3 is an invalid concentration measurement and is due to an appropriate alarm condition. It will also be displayed when initially starting the instrument until completion of the monitor's first successful measurement sample.

**Note:** Returning to the Main Operating screen will place the unit in an ON and ready to sample at the top of the hour state. If the unit is in an OFF state and at some other screen the unit will return to the Main Operating screen 55-minutes after the last operator keypress. Leave the pinch rollers latched in the UP position if you do not want the unit to restart automatically. **Warning:** Do not forget to undo the latch before you leave the site!

Table 3-1 describes the other parameters visible in the main sampling display as shown in Figure 3-2. In addition to the hourly and real-time average concentrations, these are all of the logged parameters in the BAM 1020:

<b>Parameter</b>	<b>Description</b>
PM2.5	The Inlet Type setting
1.2 ug/m3	The concentration at Actual conditions of the last hourly sample
Status	The current operational status or alarm condition of the monitor
ConcS	The concentration at Standard conditions of the last hourly sample
Flow	The sample air flow rate in Actual LPM
Membrane	Results of the last span membrane test
AT	BX-597A or BX-598 AT sensor reading
RH	BX-597A RH sensor reading
BP	BX-597A BP sensor reading
Filter Temperature	Internal Filter Temperature after the filter tape
Filter RH	Internal Filter RH after the filter tape
Filter Pressure	Internal Filter Pressure after the filter tape
Inlet Heater	Current operating percentage of the inlet heating element
WS	MSO / AIO 2 wind speed sensor reading
WD	MSO / AIO 2 wind direction sensor reading

**Table 3-1 Main Display Parameter Descriptions**

## 3.2 Menu Hierarchy and Navigation

The BAM 1020 menu structure is outlined in the following table.

Main Menu	Sub Menu Options	Overview
Operate See Section 3.3	Load Filter Tape Transfer Data Conc Chart About	Load and properly tension the filter tape Download stored data to a USB memory stick Displays the hourly concentration for the last 24-hours in chart form Details the unit serial number and firmware revision number
Test See Section 0	Leak Test Ambient Temperature Ambient Pressure Flow Calibration Self-Test Filter Sensors Span Membrane Tape Sensors Inlet Heater Beta Counter Membrane Sensors Nozzle Sensors Digital Link Relay Output Analog Calibration Analog Output	Perform the leak test Calibrate ambient temperature or restore default settings Calibrate ambient pressure or restore default settings Calibrate flow rate or restore default settings Run the Self-Test Calibrate filter temp, pressure, and RH or restore default settings Run the zero and span foil tests Verify proper operation of the sensors for tape positioning Manually turn the inlet heater on and off Verify beta counting Verify proper operation of the sensors for membrane positioning Verify proper operation of the sensors for nozzle positioning Verify and configure digital sensor network Manually open and close the alarm relay Calibrate the analog output Test the analog output
Setup See Section 3.5	Clock Sample Flow Calibration Inlet Heater Units Clear memory Password Reports Alarms Station ID Met Average Analog Outputs Serial Port Modbus Ethernet Ethernet Config Sound Volume Touch Calibration Language	Set the date and time Set sample configuration Set the Standard Temp to use for standard conditions flow calculation Set background, Span membrane (ABS) value, and span periodicity Configure heater operation, set points, and RH thresholds Configure BP units Clear stored data and alarms Enable, disable, set, or change the password Set type of report and time stamp to start or end of hour Settings for concentration error, delta-P thresholds, and maintenance flag Set the location number used to identify the BAM 1020 Set averaging interval for collecting meteorological data Configure the parameters for both analog outputs Set the baud rate and connection type for serial communications Set the Modbus communication type and address Set or update Ethernet communication options View current Ethernet options and MAC address of the BAM 1020 Adjust the volume of the touchscreen sounds Calibrate the touch screen Select the language to display on the touch screen menus
Alarms See Section 6.4	No sub menu	View alarms

**Table 3-2 Main Display Parameter Descriptions**

Menu selections and instructions are detailed in the following sections of this operating manual as detailed in the Main Menu column Table 3-2 above.

To access the various main menus, press the three horizontal lines in the top left corner. A drop down menu will appear (Figure 3-3) to allow selection of any of the four main menus. This option is available on all main menu screens (such as the Setup Menu shown in Figure 3-4) and on the main operating screen.

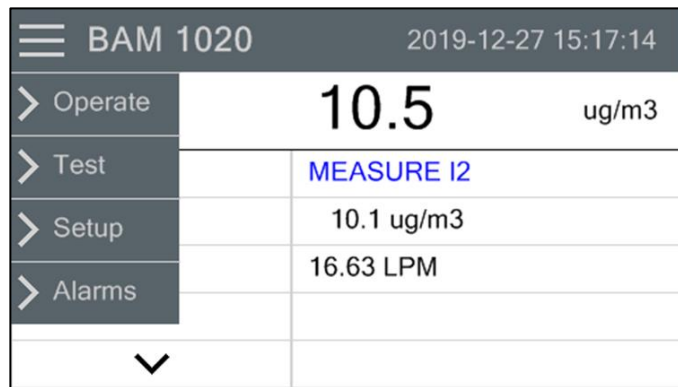

Figure 3-3 Main Menu Drop Down Selections

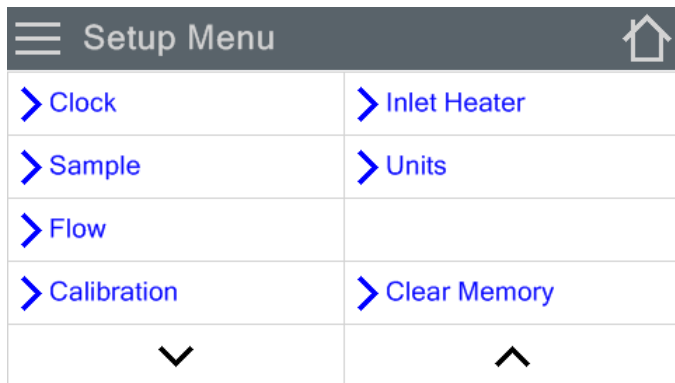

Figure 3-4 Setup Menu

To return to the main operating screen (see Section 3.1), press the Home icon located in the upper right corner of all main menu screens. This icon can clearly be seen in the Setup Menu image shown here on Figure 3-4.

To cancel an action and return to the previous menu screen, press the X icon located in the upper right corner of all sub menu screens. This icon can clearly be seen in the Set Clock screen image in Figure 3-5.

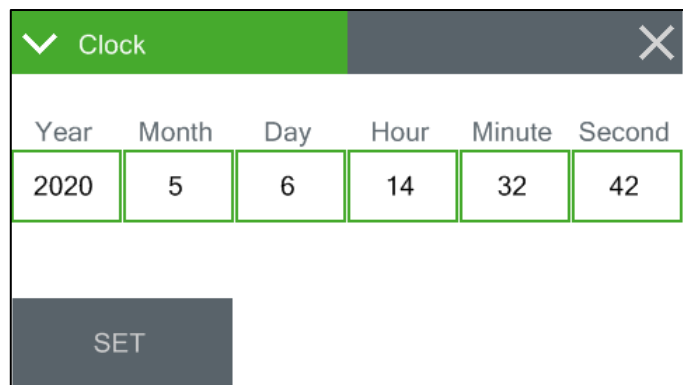

Figure 3-5 Set Clock Screen

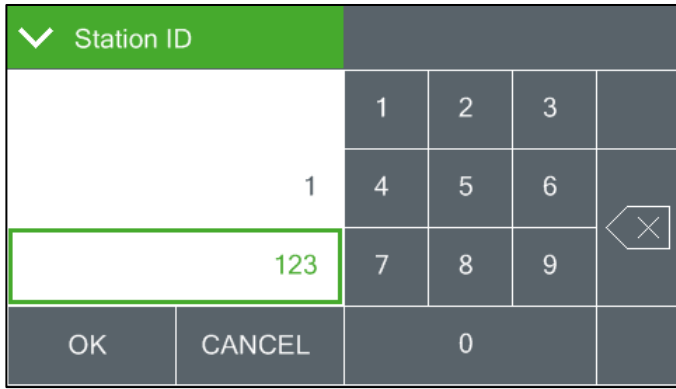

Figure 3-6 Visual Keypad for Numeric Entry

Some parameters, such as the Date and Time settings (Figure 3-5) or a Location value, require numeric entry. When a button is pressed to edit such a field, a visual keypad (Figure 3-6) will open up and provide a means to input the value. Press the OK key to accept the changes or the Cancel key to return to the previous screen. The X key on the far right performs a backspace operation. A similar screen also exists for letters and pick lists.

### 3.3 The OPERATE Menu

Selecting the Operate Menu from the menu selection drop list (see Figure 3-3) provides access to the most commonly used areas for normal operation of the BAM 1020 monitor. This will not interrupt the sample if already running.

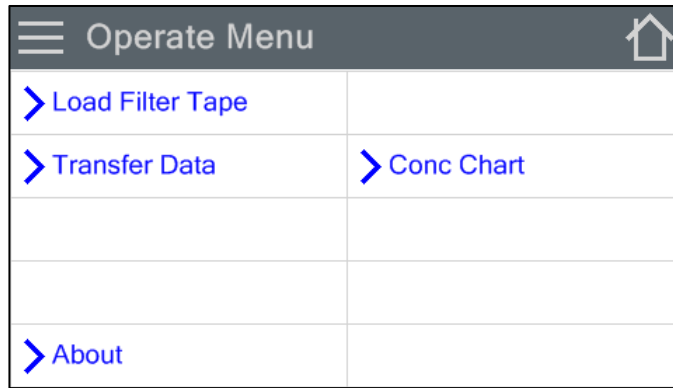

Figure 3-7 The Operate Menu

#### 3.3.1 Load Filter Tape

This menu option is used for filter tape installation. Load the tape and press the X key to go back to the Operate Menu. See Section 4.4 for details.

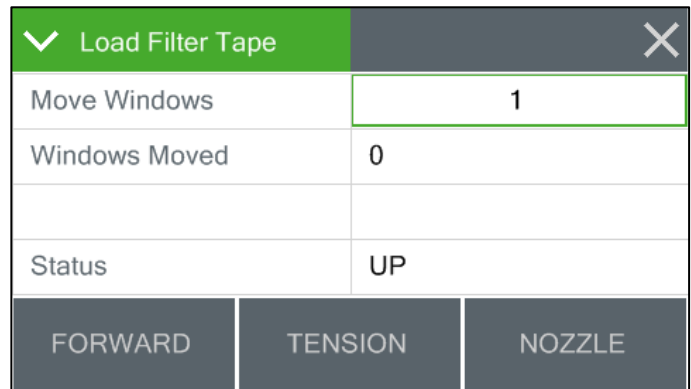

Figure 3-8 The Load Filter Tape Screen

### 3.3.2 Transfer Data

Use this screen to copy data to a USB memory stick (flash drive).

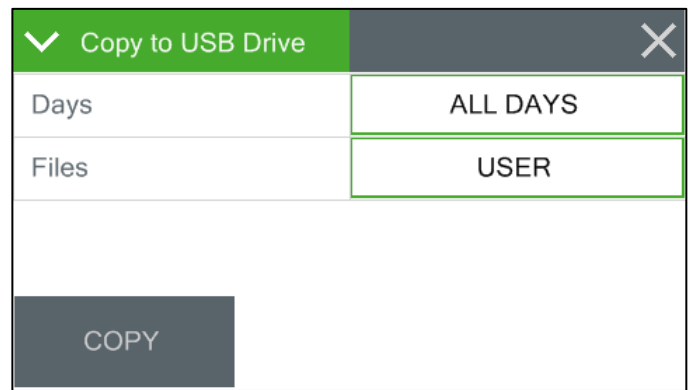
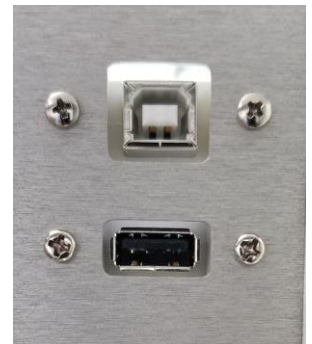

Figure 3-9 The Transfer Data Screen

The BAM 1020 can copy data files directly to a user-supplied USB flash drive. This drive must be installed in the USB Type A port located on the upper right-hand corner of the transport plate (Figure 2-4). This USB port is not used for any other purpose.

The Days field determines how many records you download. Enter the number of days between 0 and 999. Note: ALL DAYS is selected by entering a 0.

The Files field determines which files to copy to the USB flash drive. The USER files (Settings, Alarms, User Data) are ones which are used for all routine data collection purposes. The ALL option includes additional factory diagnostics files (Flow Stats, 5-Min Flow and Factory Diagnostics) which are only used if data is being sent to Met One Instruments for factory support.



Locate the USB slot on the transport plate and insert a USB memory stick.

Press the COPY button to copy the selected data to the USB memory stick.

When the COPY COMPLETE message is displayed, remove the USB memory stick and close the front door of the BAM 1020.

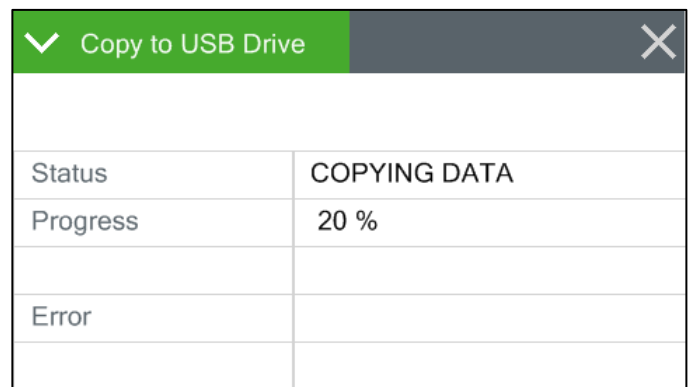
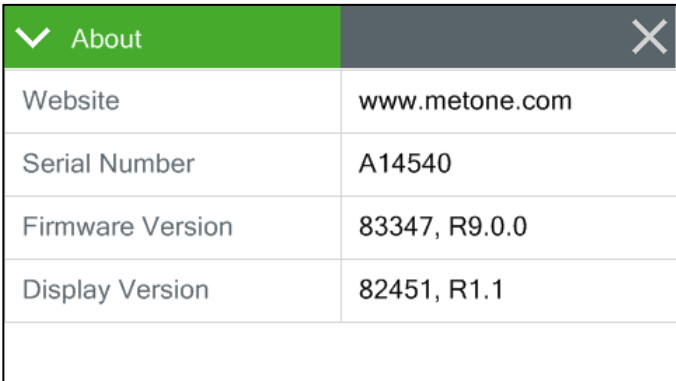

Figure 3-10 The Copy to USB Drive Screen

### 3.3.3 About

This screen shows the monitor's serial number and installed firmware revision. It also provides the firmware revision of the touchscreen display.



The screenshot shows a window titled 'About' with a green header bar containing a dropdown arrow and a close button. The main content is a table with the following data:

Website	www.metone.com
Serial Number	A14540
Firmware Version	83347, R9.0.0
Display Version	82451, R1.1

Figure 3-11 The About Screen

### 3.3.4 Conc Chart

This screen shows a chart of the previous 24 hourly concentration measurement. This makes it easy for operators to see any trends in recent concentration levels.

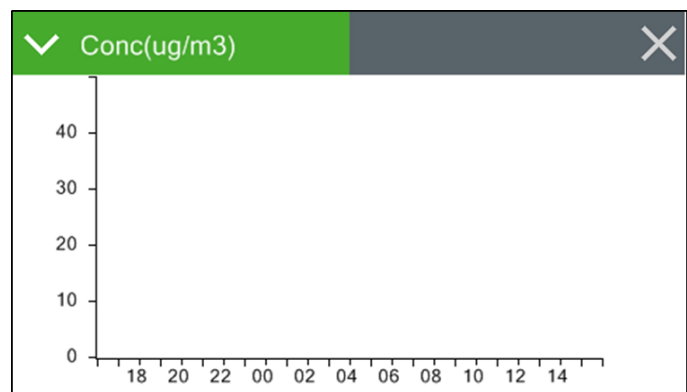

Figure 3-12 The Conc Chart Display

### 3.4 The TEST Menu System – Overview

The BAM 1020 Test menus provide a means for testing the overall operational health of the monitor. They are used for performing diagnostic checks on the BAM 1020 sub-systems and can be invaluable for troubleshooting purposes. The following sections provide an overview of the screens used to perform calibrations and audits of various sensors, as well as some advanced diagnostics to resolve failures and errors.

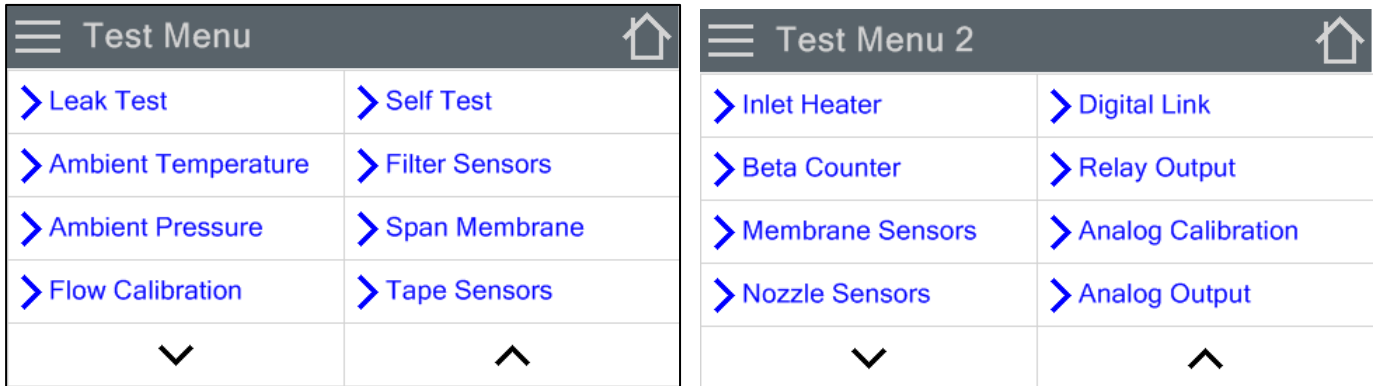

Figure 3-13 The Test Menu

#### 3.4.1 Leak Test

This screen provides the options and indications needed to perform a leak test of the sampling system. The pump control button in the lower left corner will read PUMP ON which indicates that pressing it will turn on the pump. Similarly, when the pump is running, this button will display PUMP OFF.

Use the LEAK ON button to lock the flow controller at its current value. This locks the flow controller in position and prevents it from rotating to regulate the flow.

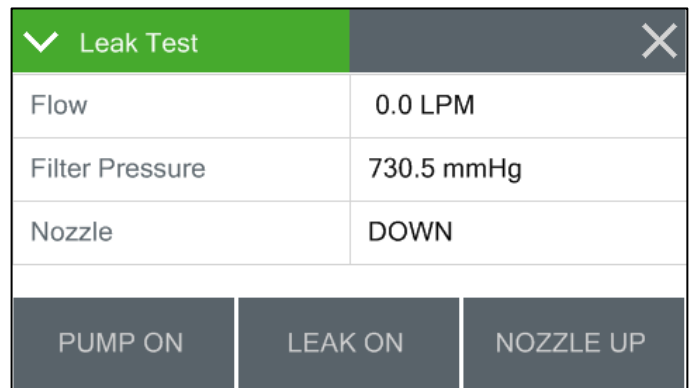

Figure 3-14 The Leak Test Screen

The nozzle control button in the lower right corner will always be labeled as NOZZLE when first entering this test screen. Pressing it will cause the nozzle to change state from up to down or down to up. The button will now display what will happen if it is pressed again, just like the pump control button. This means that it will read NOZZLE UP if the nozzle is in the down position or NOZZLE DOWN if it is in the up position.

The Flow, Filter Pressure, and Nozzle fields are provided for reference when performing the leak test. See Section 6.3.5 for detailed instructions on performing a leak test.



### 3.4.2 Ambient Temperature

This screen provides the options and indications needed to default, verify, and calibrate the ambient temperature sensor as part of the flow audit and calibration. See Section 6.3.7.1 for detailed instructions.

Ambient Temp	
BAM 1020	23.69 C
Reference	+23.7
DEFAULT	CALIBRATE

Figure 3-15 The Ambient Temperature Screen

### 3.4.3 Ambient Pressure

This screen provides the options and indications needed to default, verify, and calibrate the ambient pressure sensor as part of the flow audit and calibration. See Section 6.3.7.2 for detailed instructions.

Ambient Pressure	
BAM 1020	729.12 mmHg
Reference	+729.1
DEFAULT	CALIBRATE

Figure 3-16 The Ambient Pressure Screen

### 3.4.4 Flow Calibration

The Flow Calibration menu is where the important flow audits, checks, and calibrations are performed on the BAM 1020. See Section 6.3.7 for detailed instructions.

Flow Calibration	
Set Point	16.67
BAM 1020	0.00 LPM
Reference	+16.67
DEFAULT	CALIBRATE

Figure 3-17 The Flow Calibration Screens

### 3.4.5 Self Test

This screen provides a means to manually run the self-test sequence

Press X to exit once it is complete.

See Section 4.5 for more details.

Self Test			
Latch	PASS	Memb Extended	PASS
Tape Break	PASS	Memb Withdrawn	PASS
Tape Tension	PASS	Nozzle Down	PASS
Shuttle Beam	PASS	Flow System	FAIL
Capstan Shaft	PASS	Nozzle Up	PASS
START			

Figure 3-18 The Self Test Screen

### 3.4.6 Filter Sensors

Filter Sensors	
Filter Sensor	TEMPERATURE
BAM 1020	25.2 C
Reference	+25.2
DEFAULT CALIBRATE	

Filter Sensors	
Filter Sensor	REL HUMIDITY
BAM 1020	42 %
Reference	+42.3
DEFAULT CALIBRATE	

Filter Sensors	
Filter Sensor	PRESSURE
BAM 1020	730.6 mmHg
Reference	+730.6
DEFAULT CALIBRATE	

Figure 3-19 The Filter Sensors Screens

These screens provide the options and indications needed to default, verify, and calibrate the filter temperature, filter humidity, and filter pressure sensors. See Section 6.2 for detailed instructions.

### 3.4.7 Span Membrane

This screen provides a means to manually run the Span Membrane Test that occurs automatically either daily or during every sample period (see Span Check in Section 3.5.4).

This test should be run if the BAM 1020 has been recording **D** errors (see Section 6.4).

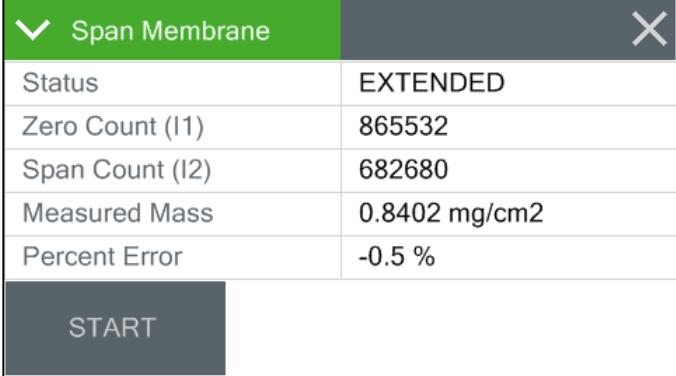

Span Membrane	
Status	EXTENDED
Zero Count (I1)	865532
Span Count (I2)	682680
Measured Mass	0.8402 mg/cm <sup>2</sup>
Percent Error	-0.5 %
START	

Figure 3-20 The Span Membrane Screen

Each BAM 1020 is provided with its individual span membrane, and this mass is measured and displayed during this test. Compare the Measured Mass value from this test with the Span Membrane value on the calibration sheet for the BAM 1020. The values must match within 5% and will typically match within just a few micrograms. If not, the most common cause is a dirty membrane foil, which can be carefully cleaned with canned air or clean water rinse. Alcohol is not used because it leaves a film. Compact Disc cleaner works well for badly soiled membranes.

**Caution: The span membrane foil is a thin sheet of polyester and is fragile.** It must be replaced if damaged. Contact the Service department for replacement instructions.

The Status field indicates the state of the membrane position.

The Zero Count (I1) value is the total beta count through the filter tape only.

The Span Count (I2) value is the total beta count through both the filter tape and the membrane and should always be less the I1 count.

The Measured Mass value is the measured mass of the foil derived from the two count values.

The Percent Error results show the amount of deviation of the Measured Mass from the Span Membrane setting value.

Press the START button to begin the test cycle. Counting will immediately begin. After some time, the I1 count will stop, the membrane will extend, and the I2 count will begin. At the completion of the test, the counting will stop, and the mass of the membrane will be calculated. The length of the test is ~8 minutes.

The Percent Error should be <+/- 5%.

### 3.4.8 Tape Sensors

This screen provides a convenient location to verify, test, and troubleshoot the various optical sensors that monitor the mechanical movement and positioning of the filter tape.

The FORWARD and BACKWARD buttons move the tape forward or backward by one sample spot.

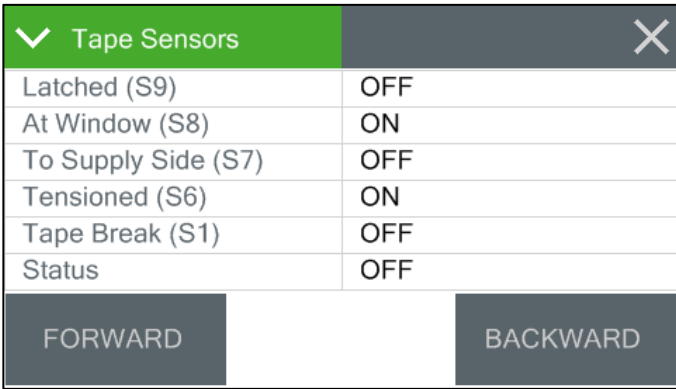

Tape Sensors	
Latched (S9)	OFF
At Window (S8)	ON
To Supply Side (S7)	OFF
Tensioned (S6)	ON
Tape Break (S1)	OFF
Status	OFF

FORWARD      BACKWARD

Figure 3-21 The Tape Sensors Screen

The states of the five photosensors that monitor all of the mechanical movement in the BAM 1020 tape transport assembly are displayed here. This is useful if the BAM 1020 has failed some of the Self-Test parameters. The sensors on this screen provide the following information:

**Latched:** This sensor shows the status of the pinch roller latch. If the rollers are latched in the UP position, then S9 should be ON. S9 should turn OFF if the latch is unhooked.

**At Window:** This photosensor indicates the rotation of the capstan shaft motor. This is the shaft under the rubber pinch rollers which drives the filter tape forwards and backwards. It normally will move the tape one sample spot (or one window). Press the FORWARD button to rotate the capstan counter-clockwise, and the BACKWARD button to rotate clockwise. The shaft should turn one-half of a rotation each time, moving the tape one window in the indicated direction. Photosensor S8 should turn ON to stop the shaft at each half-turn and will be OFF while the shaft is turning. It is helpful to put an ink mark on the end of the shaft to more easily observe the rotation.

**To Supply Side:** This photosensor monitors the position of the shuttle beam (the two outer tape rollers that move together). The status of photosensor S7 should only change to ON when the beam is moved all the way to the right (or supply tape spool) side. The shuttle must be moved by hand for this test. It rides on a ball slide and is not motor-driven. **Note:** *This test may cause the filter tape to break. It should be removed before testing this sensor.*

**Tensioned and Tape Break:** These photosensors monitor the position of the right-side spring-loaded tape tensioner. The tensioner must be moved by hand. When the tensioner is in the leftmost position under its spring pressure, both sensors S6 and S1 should be OFF. If the tensioner is moved to the middle of its travel, photosensor S1 should be ON and S6 OFF. When the tensioner is at the rightmost position, S1 and S6 should both be ON. These are the sensors which monitor tape breakage and tape tensioning. The left side tensioner assembly has no photosensors. **Note:** *This test may cause the filter tape to break. It should be removed before testing this sensor.*

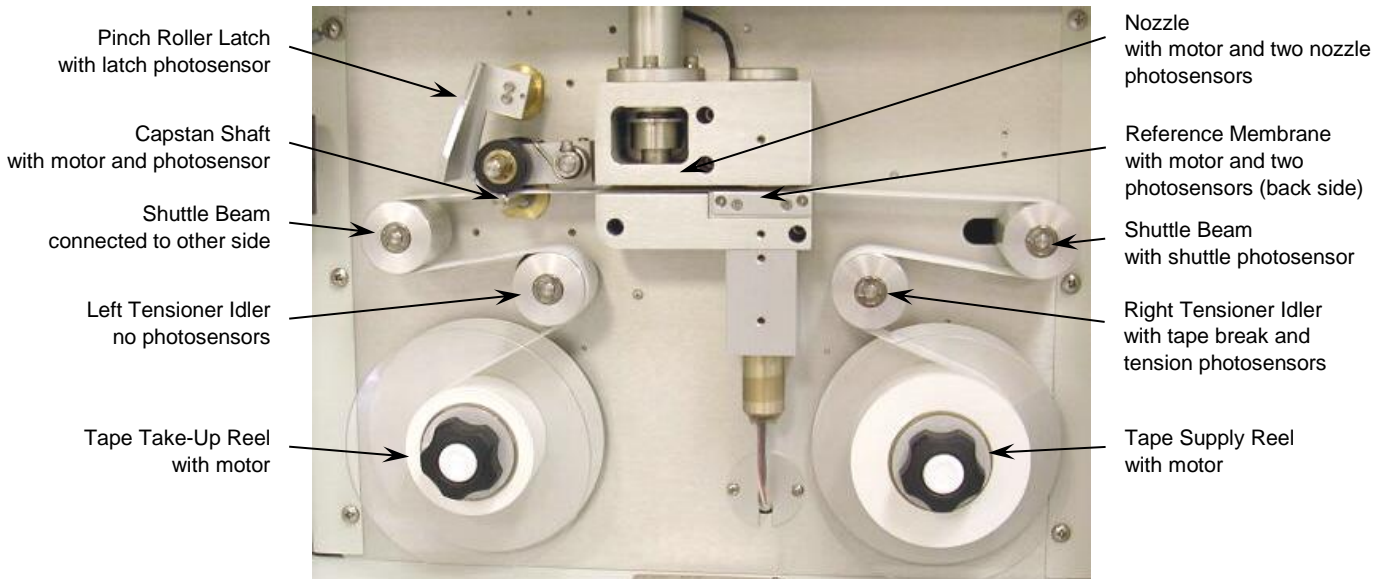

**Figure 3-22 The Tape Transport Assembly**

### 3.4.9 Inlet Heater

This screen allows manual operation of the inlet heater assembly. Press ON to turn the heater on and verify the element heats up as expected. Press OFF to turn the heater off; verify it shuts off and then cools down. Exiting this test screen will also turn off the heater.

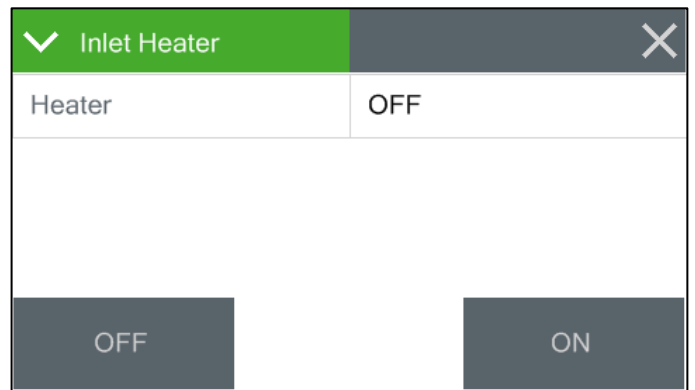
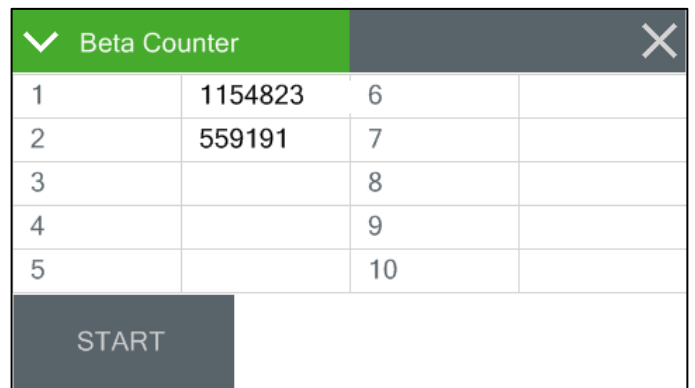

**Figure 3-23 The Inlet Heater Screen**

### 3.4.10 Beta Counter

This screen allows for testing of the beta detector and beta source. The length of one count test is determined by the Beta Count setting.

Each count test will show the number of beta particles being counted as they accumulate. The final count total will stay on the display after the counting is finished.



**Figure 3-24 The Beta Counter Screen**

Up to ten count tests can be displayed on the screen at once. Count tests are usually performed with a clean section of filter tape between the source and detector, as in normal operation.

Press the START button to start the count test. The count value on the screen will immediately begin to count rapidly if the detector is operational and unobstructed. Typical values for a 4-Minute Beta Count test through clean filter tape are between 600,000 and 1,100,000 counts. The count total will be lower if the membrane is extended. After the Beta Count time has elapsed the next Beta Count time will begin.

**Dark Count Tests:** A steel shim such as Met One Instruments part number 7438 can be placed between the beta source and detector to perform a dark count test. The shim blocks all beta particles, and only counts created by noise or cosmic rays will appear. The total four-minute dark count value should be less than 10 counts. If the total is more than 50 counts, contact the Met One Instruments service department for assistance (see Section 1.2).

### 3.4.11 Membrane Sensors

This screen tests the two photosensors which monitor the position of the reference membrane assembly. Pressing the EXTEND button extends the membrane out of the housing and positions it over the filter tape. The WITHDRAW button retracts it back into the housing. It takes a few seconds for the membrane to complete the full range of travel.

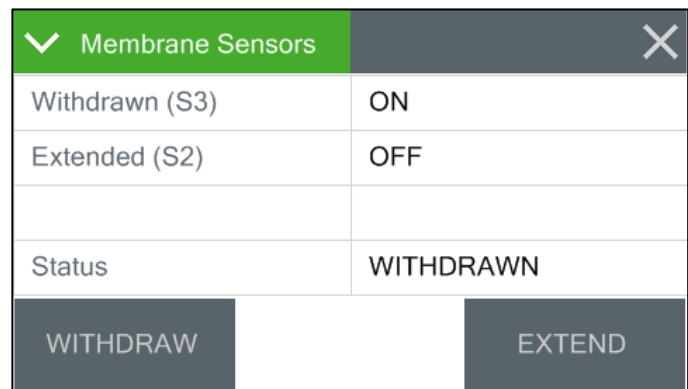

Figure 3-25 The Membrane Sensors Screen

When the EXTEND button is pressed, the membrane should extend and the S2 photosensor should turn ON while S3 should turn OFF. When the WITHDRAW button is pressed the membrane should withdraw and the S2 photosensor should be OFF and S3 ON. While the membrane is traveling, both S2 and S3 will be OFF.

### 3.4.12 Nozzle Sensors

The Nozzle Sensors screen is used to test the two photosensors which monitor the position of the nozzle assembly. Pressing the NOZ UP button raises the nozzle up off of the filter tape. The NOZ DOWN button lowers the nozzle until it seals against the tape.

The Status field indicates the current position of the nozzle as either UP or DOWN.

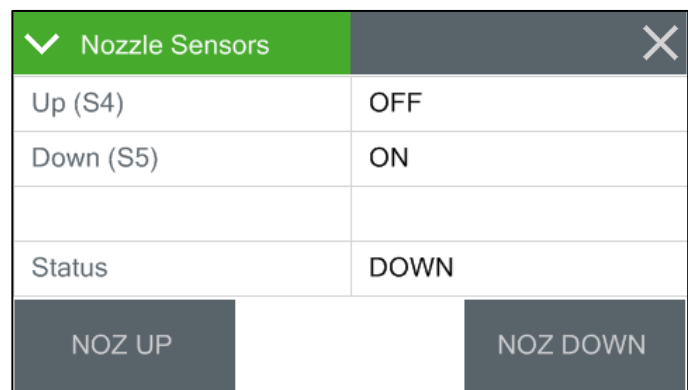

Figure 3-26 The Nozzle Sensors Screen

When the nozzle is in the UP position, the S4 photosensor will be ON and S5 will be OFF. Conversely, when the nozzle is in the DOWN position (as shown in Figure 3-26), S4 will be OFF and S5 will be ON.

### 3.4.13 Digital Link

Test digital communications with the BX-597A / BX-598 sensor by using this screen. The Digital Link should indicate OK when the proper link is established.

See section 2.7 for details on how to configure the BX-597A / BX-598 sensor, as well as any optional wind sensors that may be connected.

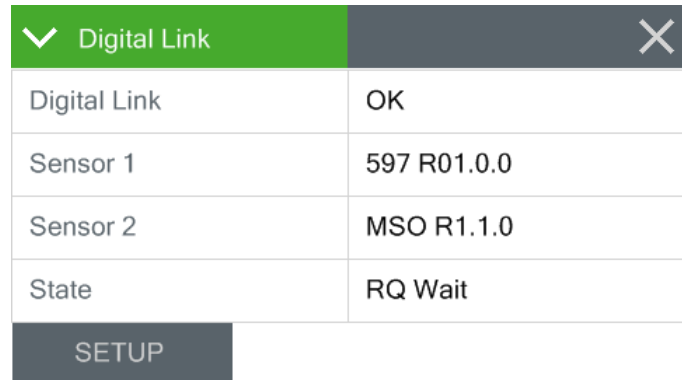

Figure 3-27 The Digital Link Screen

### 3.4.14 Relay Outputs

This screen is used to test the Alarm relay on the back of the BAM 1020. The relay contact is Normally Open (NO).

Verify that the contact closure output on the back panel terminals responds accordingly using an Ohm-meter.

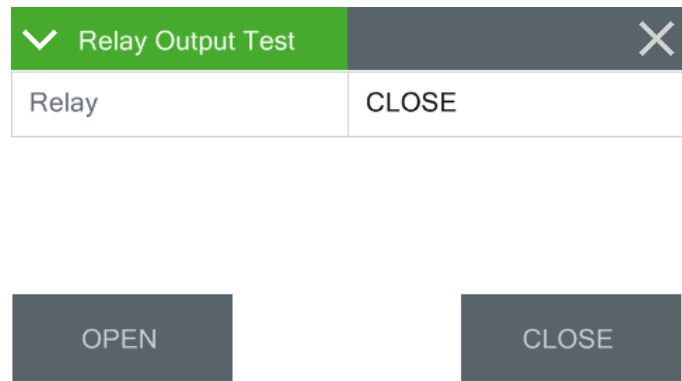

Figure 3-28 The Relay Output Screen



### 3.4.15 Analog Calibration

This screen allows for calibration of the two analog output channels.

The channel field defines whether output number one or two is being configured. Tap the green bordered Channel selection box to select the desired channel. The voltage range will be displayed in the Range value box. Use the Analog Outputs screen in the Setup menu to adjust this range. See Section 3.4.16.

✓ Analog Output Cal		✕
Channel	1	
Range	0-5.0 V	
Measure	0.0 V	
Adjust	0	
RESET	FINE	<div style="display: flex; justify-content: space-around;"> <span>∨</span> <span>∧</span> </div>

Figure 3-29 The Analog Calibration Screen

After selecting the output channel, the Measure field may be adjusted to maximum or minimum value and the output of the channel confirmed. Just tap the green bordered Measure box and select the desired test output. Verify the actual output using a voltmeter at the appropriate channel terminals on the rear panel of the BAM 1020.

If the output is not correct, use the up and down arrow keys to modify the Adjust field. When the FINE/COARSE selection is set to FINE, units will be incremented by one. If it is set to COARSE, the units will be incremented in tens. Tap the button to swap between the two options.

Pressing the X key to exit the screen will save any adjustments that have been made. To clear any custom settings and restore the factory defaults, press the grey RESET button.

**Note:** This function is critical for all users of external analog data loggers. Measure the voltage all of the way to the input of the data logger. *Every millivolt of error is a microgram of error!* Make sure the logger is scaling the voltage correctly. In most cases 0.000V should scale as -0.015mg, and 1.000V should scale as 0.985mg. See Section 3.5.13.

### 3.4.16 Analog Output

To test the analog output channels, select channel number one or two on the top row marked Channel by pressing the green bordered Channel selection box.

Next, set the desired concentration level using the Conc Output field. Press the green bordered selection box and set the concentration value. It will need to be within the range configured range, typically between -15 and +985. See Section 3.5.13.

✓ Analog Output		✕
Channel	1	
Conc Output	-15	
Max Out	5.000 V	
Set Out	0.000 V	
Min Out	0.000 V	

Figure 3-30 The Analog Output Screen

The Min Out and Max Out fields should match the zero and full scale values for the selected output. Between them is the Set Out field, which will update with the expected output based on the concentration selected in the Conc Output field. Verify the output on the back of the BAM 1020 matches the Set Out value shown using a voltmeter.



**Note:** This function is critical for all users of external analog data loggers. Measure the voltage all of the way to the input of the data logger. *Every millivolt of error is a microgram of error!* Make sure the logger is scaling the voltage correctly. In most cases 0.000V should scale as -0.015mg, and 1.000V should scale as 0.985mg. See Section 3.5.13.

### 3.5 Setup Menu Description

The BAM 1020 uses a comprehensive system of setup menus which contain all of the settings and parameters needed to perform the measurement and operation of the BAM 1020. Most of these settings are set at factory default values, although some settings may be altered by the operator. This section describes the SETUP menu in detail and should be reviewed when the instrument is first put into service. Once set, most of the values in the SETUP menus will not need to be changed. The SETUP values will not be lost if the BAM 1020 is unplugged or powered down.

**WARNING: Some of the settings in the SETUP menus are unit-specific calibration constants which must not be changed, or the accuracy and proper operation of the BAM 1020 may be affected.**

Select the SETUP from the drop down selection (see Figure 3-3). The Setup Menu provides a choice of operations. Use the arrow keys to navigate to the desired field, then press the SELECT soft-key to enter.

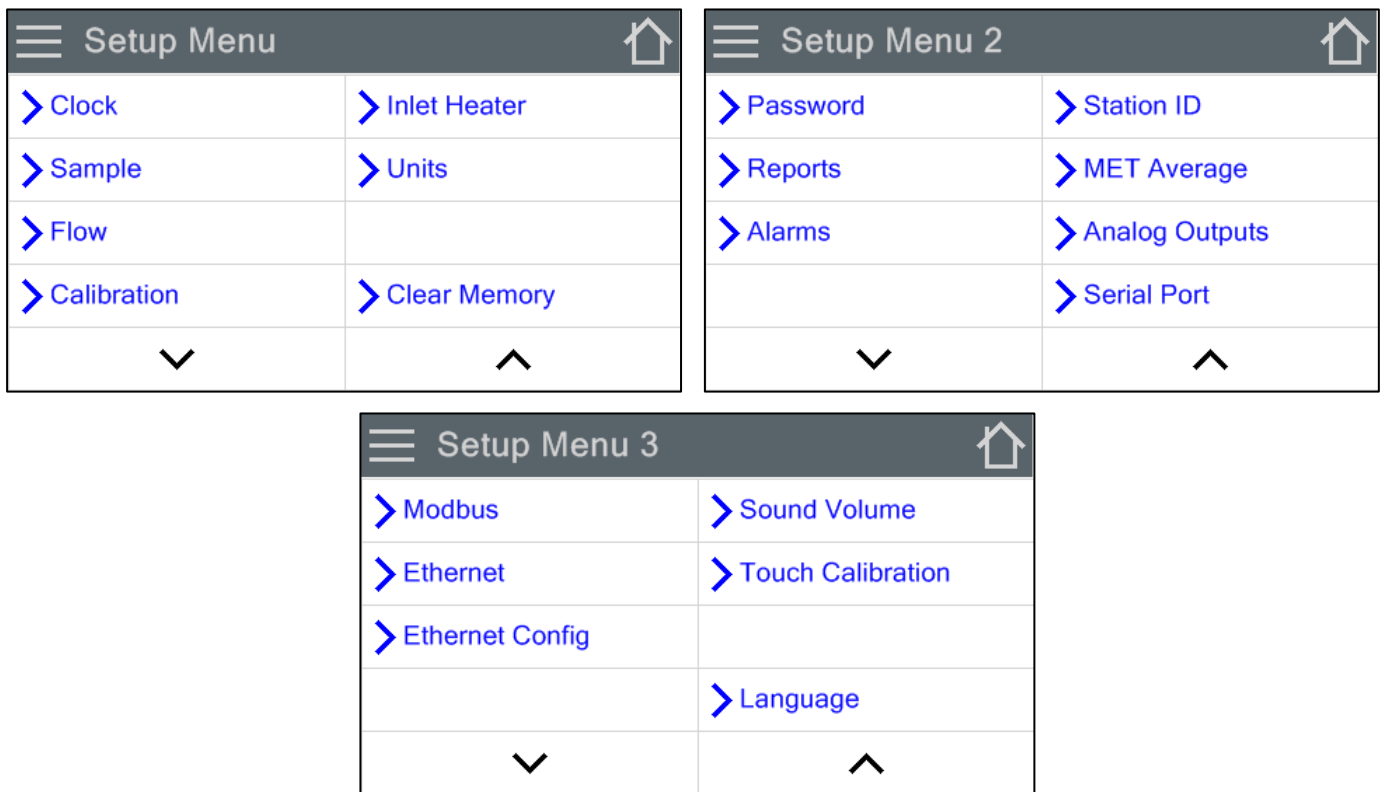
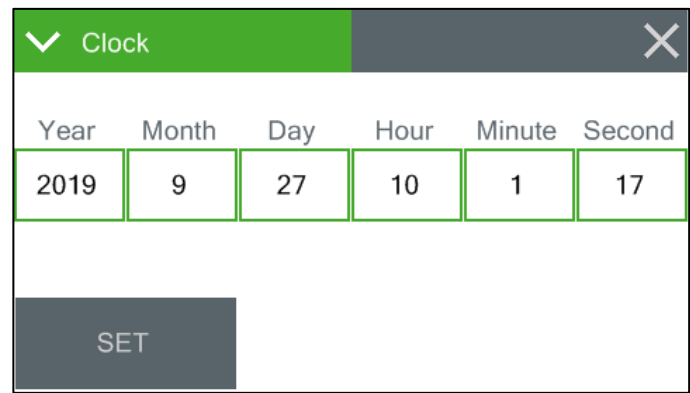

Figure 3-31 The Setup Menus

### 3.5.1 Clock

This is the screen used to set the date and time. Edit each field as required. Once all fields have been entered, press the SET button to set the clock.



The screenshot shows a 'Clock' screen with a green header and a close button (X) in the top right. Below the header is a table with six columns: Year, Month, Day, Hour, Minute, and Second. The values are 2019, 9, 27, 10, 1, and 17 respectively. Below the table is a 'SET' button.

Year	Month	Day	Hour	Minute	Second
2019	9	27	10	1	17

SET

Figure 3-32 The Clock Screen

Note that time is configured as a 24-hour clock only. The lithium battery backup keeps the clock running during power-down. Met One Instruments, Inc. recommends a monthly check of the clock.

**Warning:** The recommended time to set the clock when the BAM is sampling is between minute 30 and minute 40. Setting the clock outside this range may cause the BAM to sample past the top-of the hour.

### 3.5.2 Sample

The Sample screen is used to configure the various parameters that directly impact the air sample measurement.

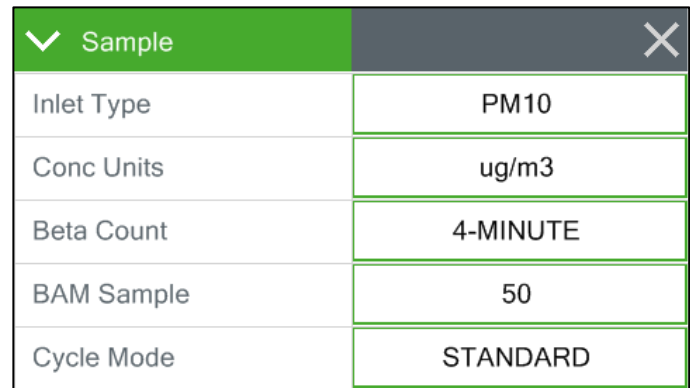

The screenshot shows a 'Sample' screen with a green header and a close button (X) in the top right. Below the header is a table with five rows: Inlet Type, Conc Units, Beta Count, BAM Sample, and Cycle Mode. The values are PM10, ug/m3, 4-MINUTE, 50, and STANDARD respectively.

Inlet Type	PM10
Conc Units	ug/m3
Beta Count	4-MINUTE
BAM Sample	50
Cycle Mode	STANDARD

Figure 3-33 The Sample Screen

**Inlet Type:** This setting helps users identify whether the BAM 1020 is collecting TSP, PM<sub>10</sub>, PM<sub>2.5</sub> or PM<sub>1</sub> data. Whichever option is selected sets the corresponding label to be displayed at the top of the main menu screen. This setting is for providing indication on the display only and does not impact any of the actual data collection or reports.

**Conc Units:** This setting determines the concentration units which the BAM 1020 displays. This can be set to µg/m<sup>3</sup> (micrograms) or mg/m<sup>3</sup> (milligrams) per cubic meter. The default setting is mg/m<sup>3</sup>.

**Note:** 1.000 mg = 1000 µg.

**Beta Count:** This value sets the number of minutes that the monitor will use to count the sample. See Section 5.1 for a description of the hourly cycle. The BAM Sample time must be set to correspond to the Beta Count value. If the BAM 1020 is used for PM<sub>2.5</sub> FEM or EU PM<sub>2.5</sub> monitoring, the BAM Sample *must be set to 42 minutes with 8-minute Beta Count time*. PM<sub>10</sub> monitors are usually set for a 50 minute sample time with 4 minute count time.

Count Time	BAM Sample	Used for
4 minutes	50 minutes	PM <sub>10</sub> monitoring (Higher “Lower Detection” limit)
8 minutes	42 minutes	All PM <sub>2.5</sub> FEM, EU PM <sub>2.5</sub> monitoring, PM <sub>10</sub> monitoring

**Table 3-3 Typical Beta Count / BAM Sample Time Configurations**

**BAM Sample:** This value sets the number of minutes per sample hour that the pump is ON. See Section 5.1 for a description of the hourly cycle. The BAM Sample time must be set to correspond to the Beta Count value as detailed in the Beta Count explanation above.

The BAM Sample setting has a range of 0-200 minutes for custom applications. If set for shorter period, such as 15 minutes, the pump will only sample for 15 minutes and then wait until the end of the hour before beginning a new cycle. This may not leave time for the membrane span check. Only one pump cycle per hour is allowed, regardless of duration. Setting the BAM SAMPLE value too long may cause the total measurement cycle to overlap into the next hour, so that the BAM 1020 only collects the concentration every second hour.

**Cycle Mode:** Set the BAM 1020 to operate in either Early Cycle or Standard mode. See Section 7.2.2 for details.

### 3.5.3 Flow

This screen allows the selection of the preferred Standard Temperature value. This is used to calculate the Standard Volume which is used to determine the Standard Concentration value shown on the main operate screen (see Section **Error! Reference source not found.**).

The available options are 0, 20, and 25 C.

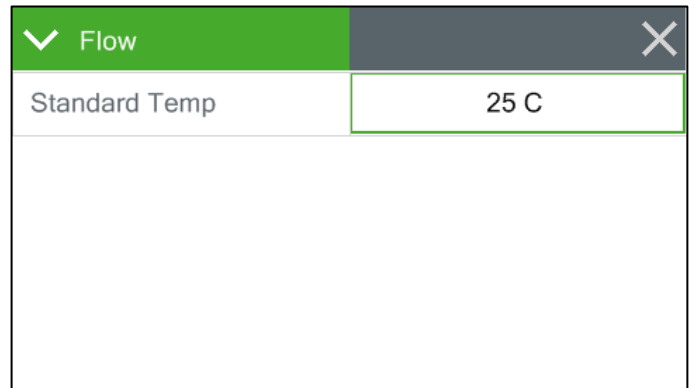
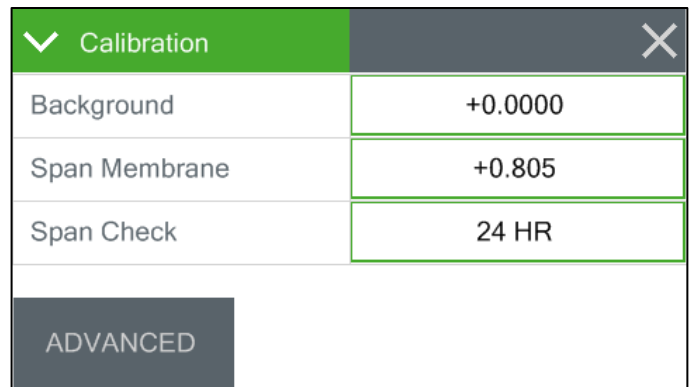

**Figure 3-34 The Flow Screen**

### 3.5.4 Calibration

This screen allows for setup of certain calibration values for the BAM 1020; the Background, Span Membrane (synonymous to ABS), and Span Check frequency

There is also an ADVANCED sub menu here that should only be accessed under the direction of Met One Instruments, Inc.



**Figure 3-35 The Calibration Screen**

**Background:** Background is used to compensate for measured mass concentration output in the absence of PM. It is determined by performing the zero test with the BX-302 Zero Filter (see Section 6.9). With a properly set Background value, a BAM 1020 making multiple readings of air with zero PM should read, on average, 0  $\mu\text{g}/\text{m}^3$ . Regardless of the concentration unit setting (see Section 3.5.4), the background is always entered in  $\text{mg}/\text{m}^3$ .

**Span Membrane:** The Span Membrane is the factory-set expected mass of the reference membrane foil used during the automatic span check. This expected value is compared to the measured value either hourly or daily (see Span Check below). Each unit's Span Membrane value is different, but is typically near 0.800  $\text{mg}/\text{cm}^2$ . **The Span Membrane value is never changed by the operator unless the span membrane foil is replaced due to damage.**

**Span Check:** This setting determines how often the BAM 1020 performs the automatic span membrane check. If the value is set to 1 HR, the BAM measures and displays the span each hour (see Section 3.1). If this value is set to 24 HR, then the BAM will only perform the span check once per day during the sample hour beginning at midnight and during any sample hour following a power failure. The resulting value will be displayed throughout the rest of the day. If this value is set to OFF, the span check will be disabled entirely.

**ADVANCED:** The ADVANCED button provides access to the factory set parameters of the K-Factor and Usw. These should never be changed without the guidance of the Met One Instruments, Inc. service department.

**WARNING:** *Altering these values voids the factory calibration and will invalidate all data collected by the BAM 1020.*

Advanced	
K-Factor	+1.000
Usw	+0.285

Figure 3-36 The Advanced Calibration Screen

A warning screen will pop up when the ADVANCED button is pressed indicating that changing these parameters will void the calibration.

**K-Factor:** This is an instrument specific calibration factor for the BAM 1020 concentrations. It is determined during the calibration process by running the BAM 1020 against a calibration standard while both are sampling from a smoke chamber over a wide variety of concentrations. The values will typically range from 0.9 to 1.1.

**$\mu\text{sw}$ :** This is called the mu-switch value and is the factory-set mass absorption coefficient used by the BAM 1020 in the concentration calculations. The value is typically around 0.3 and may vary slightly from one BAM 1020 to the next.

### 3.5.5 Inlet Heater

This menu is used to configure the settings used by the BAM 1020 to control the Smart Inlet Heater. The BAM 1020 uses an RH sensor located below the filter tape in the sample air stream to monitor the conditions of the air as it is being sampled. If the measured relative humidity of the sampled air stream is higher than about 50% then PM measurements might be skewed higher than those of a collocated reference sampler. The Smart Heater can reduce this effect by actively heating the inlet tube by warming the sampled air stream whenever the RH value measured downstream of the filter tape exceeds a user selectable value.

These are the default settings for the Smart Heater. Unless there is a compelling reason to change them, it is highly recommended to leave these settings at their default values.

Inlet Heater	
FRH Set Point	+35
Low Power	+20

Figure 3-37 The Inlet Heater Menu

**RH Set point:** This is the relative humidity level that the filter will be regulated at or below by the inlet heater. This value must be set to 35% for the version of the BAM 1020 employing the smart heater when operated as a PM<sub>2.5</sub> US-EPA designated federal equivalent method. The RH set point is set to 45% for European (EU) PM<sub>2.5</sub> units and may be either 35% or 45% for PM<sub>10</sub> units. The RH set point is otherwise adjustable from 0% to 99%.

**a:** This is the power level of the smart heater when the Filter RH value is below the FRH setpoint. A 20% setting should be used for 115 VAC heater (BX-827) and 6% for 230 VAC heater (BX-830).

It should be noted that the relative humidity downstream of the filter tape will typically not be the same as the ambient relative humidity. Relative humidity is a measure of how much moisture the air is holding compared to how much moisture the air can hold (dew point) and is strongly temperature dependent. For example, if the ambient relative humidity is 50% and the ambient temperature is 3°C, the relative humidity downstream of the filter tape would be about 22 % were the filter temperature 15°C, which means that the Smart Heater would not have to apply additional heat were the BAM 1020 to be operated inside of a temperature-controlled enclosure set to maintain an instrument temperature of about 20 °C in order to maintain the filter temperature RH value of 35%.

### 3.5.6 Units

The Concentration and Pressure units are selected here.

The Conc Units are ug/m<sup>3</sup> and mg/m<sup>3</sup>.

The Pres Units are mmHg and kPa.

Units	
Conc Units	ug/m <sup>3</sup>
Pres Units	mmHg

Figure 3-38 The Units Screen

### 3.5.7 Clear Memory

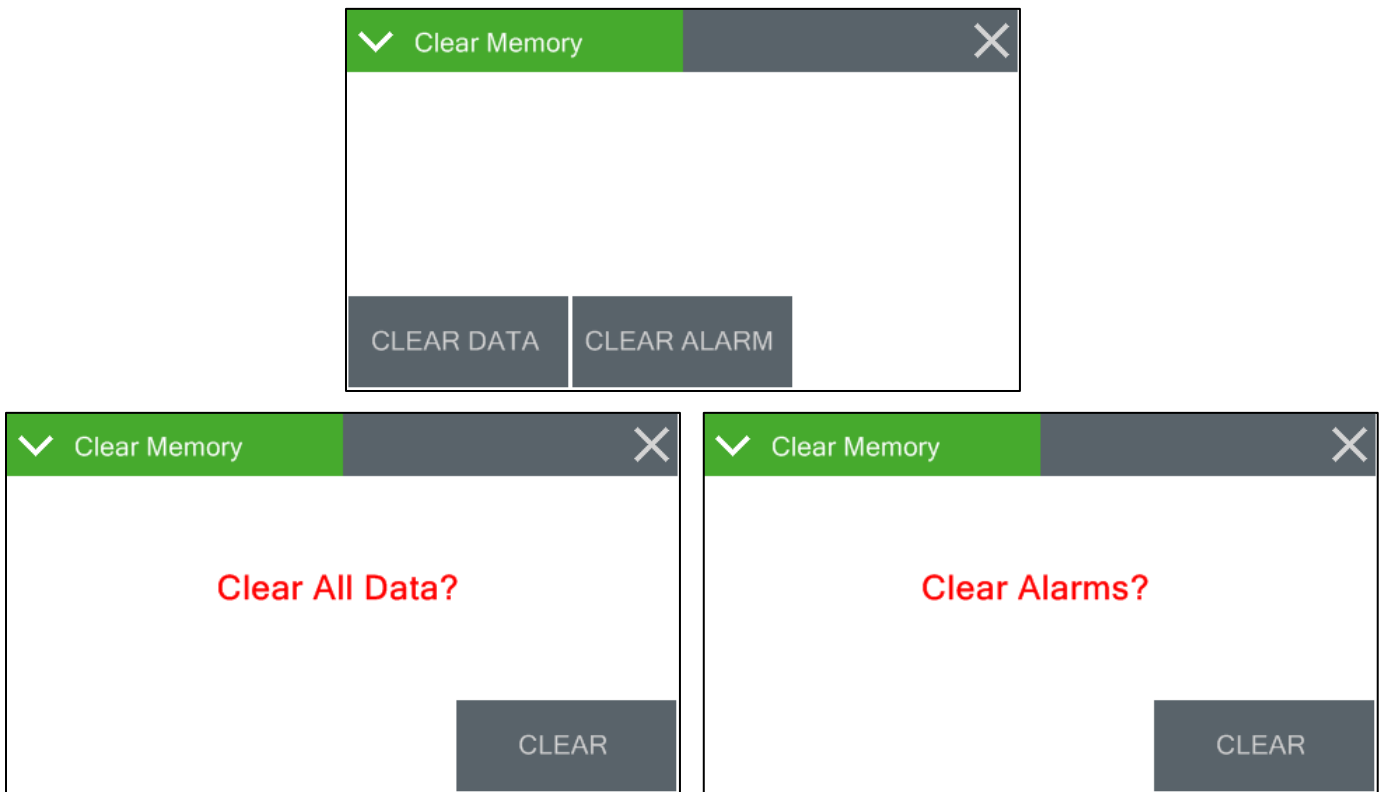

**Figure 3-39 The Clear Memory Screens**

The alarm and data logs may be cleared from this screen. Press CLEAR DATA button to clear the data logs (Data, Flow Stats, and 5-Min Flow files) or press the CLEAR ALARM button to clear the alarm log. A confirmation screen will appear to confirm clearing the selected memory log (see Figure 3-39). Press the CLEAR button to proceed with clearing the data or alarm logs. Press the X in the upper right corner to cancel the operation without erasing the memory.

### 3.5.8 Password

Critical settings and calibrations on the BAM 1020 are password protected. Any four digit password may be used for this purpose and the Password screen provides the means to set, change, or disable this protection.

This password is also applied to the serial port commands..

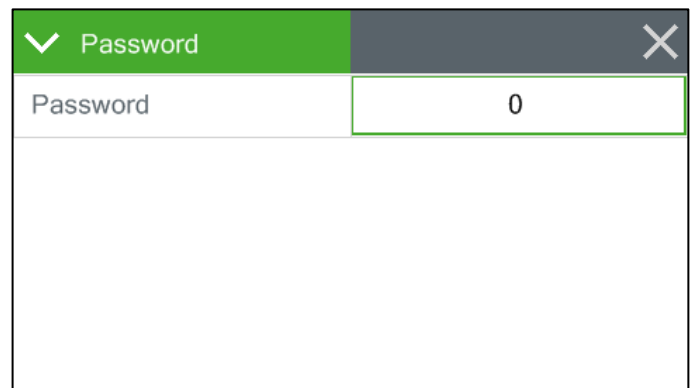

**Figure 3-40 The Password Screen**

The default password is 0. Setting the password to 0 means no password is used. Met One Instruments, Inc. does not recommend changing the default password unless absolutely necessary. Contact the Met One Instruments service department (see Section 1.2) for instructions if the password is lost or forgotten.

### 3.5.9 Reports

The BAM 1020 offers three different CSV report types (comma-separated values); Standard, Generation 2, and China HJ 653. The Standard report is accessed from the serial ports or the USB flash drive. The Generation 2 and China HJ 653 reports are only available from the serial port when the Protocol Type is set to Generation 2. The Generation 2 and China HJ 653 reports are available for backward compatibility to the previous BAM 1020 (Generation-2)

The Protocol Type setting is only available by the serial port command PT. The Protocol Type selections are PT 0 (7500) for the standard and preferred type and PT 1 (GEN2) for Generation 2 compatibility.

The Time Stamp field can be set to mark the collected data with the time from either the beginning or ending of the sample period. For example, if set to BEGINNING, data collected during the hour from 08:00 to 09:00 would be marked as 08:00. Similarly, if that data were collected with ENDING as the choice, the data time stamp would be 09:00 instead. The default setting for Time Stamp is ENDING. The BEGINNING setting only works when the Met Average period is set to 1 HR (see Section 3.5.12).

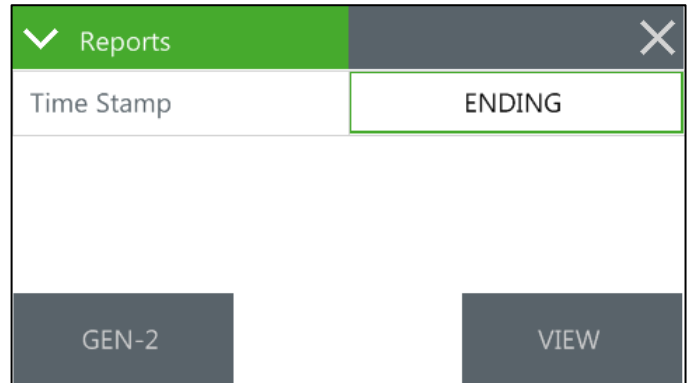

Figure 3-41 The Report Setup Screen

#### 3.5.9.1 Standard Report

Press the VIEW button to display the Standard report format. The Standard report is the default report type. The Standard report requires minimal configuration, Time Stamp, Concentration Units and Pressure Units.

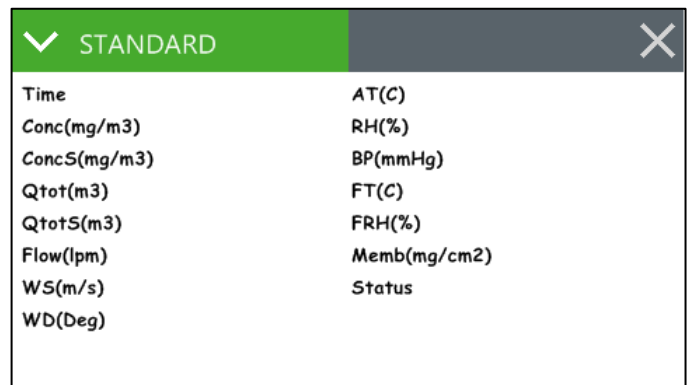

Figure 3-42 The Standard Report

The following is the description of each report parameter.

<b>Parameter</b>	<b>Description</b>
<b>Time</b>	The beginning or ending Time Stamp (Figure 3-41) of the data record being reported. The Standard report time format is <code>yyyy-MM-dd HH:mm:ss</code> . The Generation 2 and HJ 653 report time format is <code>MM/dd/yy HH:mm</code> .
<b>Conc(mg/m3)</b>	The sample mass concentration at actual temperature and barometric pressure conditions. Concentration Units (Figure 3-38) are either ug/m3 or mg/m3.
<b>ConcS(mg/m3)</b>	The sample mass concentration at Standard Temperature (Figure 3-34) and barometric pressure conditions (760 mmHg). Concentration Units are either ug/m3 or mg/m3.
<b>Qtot(m3)</b>	Total air sample volume for the BAM Sample period (Figure 3-33) at actual temperature and barometric pressure conditions.
<b>QtotS(m3)</b>	Total air sample volume for the BAM Sample period at Standard Temperature and barometric pressure conditions (760 mmHg).
<b>Flow(lpm)</b>	The average flow rate for the BAM Sample period.
<b>WS(m/s)</b>	The average wind speed for the MET Sample period (Figure 3-51).
<b>WD(Deg)</b>	The vector average wind direction for the MET Sample period.
<b>AT(C)</b>	The average ambient temperature for the MET Sample period.
<b>RH(%)</b>	The average ambient RH for the MET Sample period. Requires a BX-597A sensor.
<b>BP(mmHg)</b>	The average ambient barometric pressure for the MET Sample period. Pressure Units (Figure 3-38) are either mmHg or kPa.
<b>FT(C)</b>	The average filter temperature for the BAM Sample period.
<b>FRH(%)</b>	The average filter RH for the BAM Sample period.
<b>Memb(mg/cm2)</b>	The Span Membrane measurement during the BAM Sample period.
<b>Status</b>	The Alarm status (Section 6.4) for the MET Sample period.



### 3.5.9.2 Generation 2 Menu

Press the GEN-2 button on the Report Setup screen to display the Generation 2 menu selection. Use these menu items to configure the Generation 2 and China HJ 653 reports.



Figure 3-43 The Generation 2 Menu

### 3.5.9.3 Report Types

There are two (2) Report Types: GENERATION 2 and CHINA HJ 653. These reports are only available from the serial port when the Protocol Type is set to Generation 2. These reports are available for backward compatibility to the previous BAM 1020 (Generation 2).

Press the VIEW button to show the GENERATION 2 or CHINA HJ 653 report format.

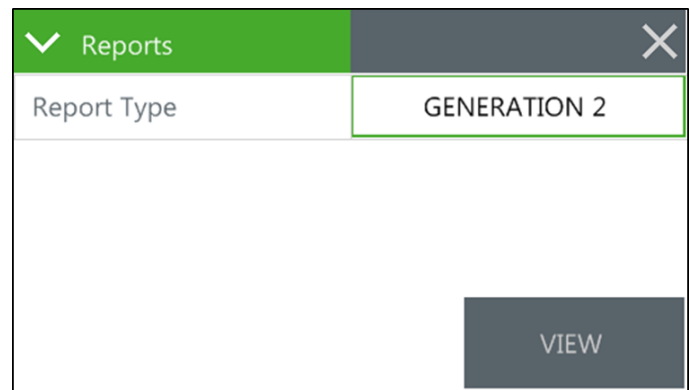

Figure 3-44 The Report Type Setup

Shown here is an example of the GENERATION 2 report type format.

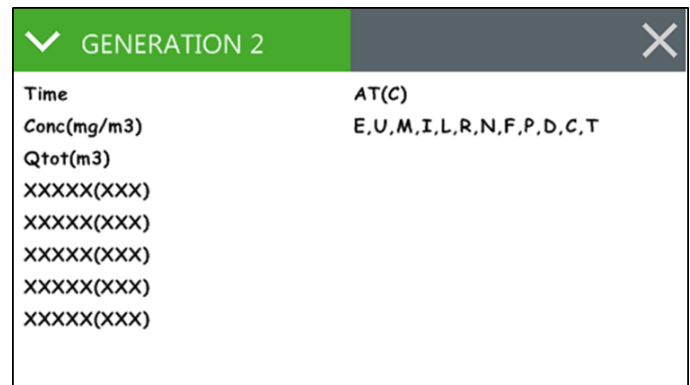

Figure 3-45 The Generation 2 Report

Shown here is an example of the CHINA HJ 653 report type format.

This report will set the data formatting to match the Chinese National Standards on Environmental Protection document HJ 653-2013.

CHINA HJ 653	
Time	AT(C)
Conc(mg/m3)	ConcS(mg/m3)
Qtot(m3)	QtotS(m3)
XXXXX(XXX)	BP(kPa)
XXXXX(XXX)	Flow(lpm)
XXXXX(XXX)	E,U,M,I,L,R,N,F,P,D,C,T
XXXXX(XXX)	
XXXXX(XXX)	

Figure 3-46 The China HJ 653 Report

### 3.5.9.4 Concentration Setup

These settings configure the concentration parameters.

Setup Conc	
Conc Type	ACTUAL
Conc Range	1000 ug/m3
Conc Offset	-15 ug/m3
Dynamic Range	EXTENDED

Figure 3-47 The Concentration Setup Screen

**Conc Type:** Sets the Concentration (Conc) Type to be reported using either ACTUAL (Conc) or STANDARD (ConcS) sample volume conditions.

In the case of the HJ 653 report it sets the order of the Concentration Type (ACTUAL or STANDARD) to be reported. The HJ 653 report format (Figure 3-46) above is for the Conc Type set to ACTUAL.

**Conc Range:** Sets the upper end of the Concentration Range for the report.

The selections are: 100, 200, 500, 1000, 2000, 5000, or 10000 ug/m3.

**Conc Offset:** Sets the lower end of the Concentration Range for the report.

The selections are: -15, -10, -5, 0, or 5 ug/m3.

For example, if the Range is 1000 and the Offset is -15 then the maximum possible concentration value reported will be 985 (1000 - 15) and the minimum possible concentration value reported will be -15. A concentration value of 1104 ug/m3 will be reported as 985 ug/m3. A concentration value of -19 ug/m3 will be reported as -15 ug/m3.

**Dynamic Range:** Sets the Dynamic Range of the concentration conversion to either STANDARD or EXTENDED. The STANDARD conversion is 4095 over the Conc Range setting. The EXTENDED conversion is 65535 over a fixed concentration range of 10000 ug/m3. The reported concentration resolution is Concentration Range divided by Dynamic Range. For example, the resolution of 10000 / 4095 is 2.4 ug/m3. The resolution of 10000 / 65535 is 0.15 ug/m3.

### 3.5.9.5 Logger Setup

The channels of the Logger Setup represent the analog inputs on the rear panel or software assignments of the Generation-2 BAM 1020.

The channel assignments shown are typical for a Generation-2 BAM 1020.

The xxxxx (xxx) report parameter represents a log channel selection of NONE.

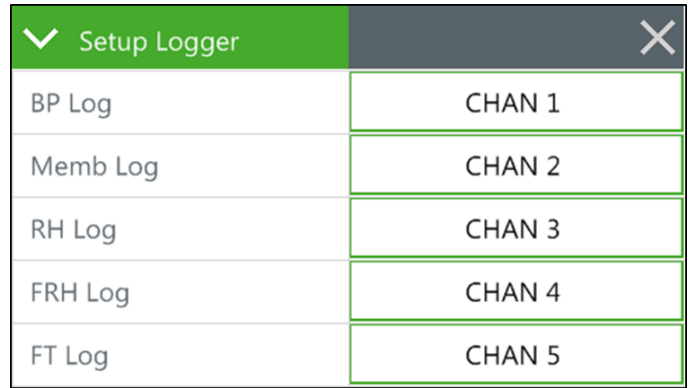

Setup Logger	
BP Log	CHAN 1
Memb Log	CHAN 2
RH Log	CHAN 3
FRH Log	CHAN 4
FT Log	CHAN 5

Figure 3-48 The Setup Logger

### 3.5.10 Alarms

The Alarms setup screen provides options for defining the behavior of certain alarms. Specifically, it allows users to determine the threshold for the filter tape pressure alarm, how a concentration error is recorded, and the ability to manually set and remove the maintenance flag.

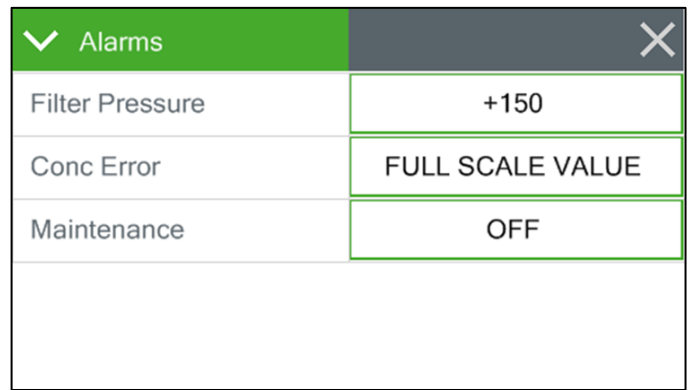

Alarms	
Filter Pressure	+150
Conc Error	FULL SCALE VALUE
Maintenance	OFF

Figure 3-49 The Alarms Screen

**Filter Pressure:** This is the maximum amount of increase in pressure drop which is allowed to occur across the filter tape due to heavy dust loading, before the “P” alarm will be generated. Setting this parameter higher will allow more dust to accumulate before the sample is terminated but may cause flow regulation problems. See the pressure-drop alarm description in Section 6.2. The default setting of **150** mm Hg is correct for most applications using the standard Medo or Gast pumps. Larger pumps can accommodate a higher Filter Pressure setting and higher dust loads while still being able to regulate the sample flow. The setting range is 0-500 mmHg.

**Conc Error:** This parameter determines what is displayed and reported whenever one of the major alarm types that affects the concentration calculation is present. Minor alarms such as E, U, R, P, or D do not trigger this behavior and will still record the actual concentration value. There are three choices: FULL SCALE VALUE, MIN SCALE VALUE, and “ERROR” TEXT.

**FULL SCALE VALUE** The full scale concentration value (99.9999 mg/m<sup>3</sup>) will be displayed on the Main Operate screen, reported on all data reports, and output on the analog output terminals.

**MIN SCALE VALUE** The minimum scale concentration value (-0.015 mg/m<sup>3</sup>) will be displayed on the Main Operate screen, reported on all data reports, and output on the analog output terminals.

**“ERROR” TEXT** The full scale concentration value (99.9999 mg/m<sup>3</sup>) will be output on the analog output terminals. The word ERROR will be displayed in place of the concentration value on the Main Operate screen. The word ERROR will also be printed in place of the concentration value in the CSV data reports.

### 3.5.11 Station ID

The BAM 1020 may be identified with a numeric station ID number. The default value is 1 but any number from 1 to 999 may be set.

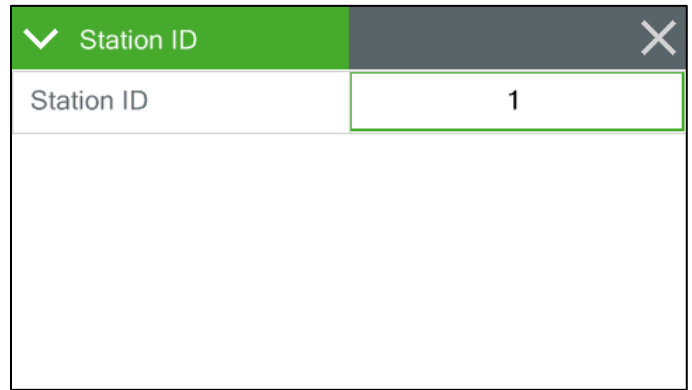

Figure 3-50 The Station ID Screen

### 3.5.12 Met Average

The averaging period for parameters other than concentration may be set to intervals shorter than one hour, if needed. The averaging interval is selected from this screen. The available average intervals are 1, 5, 10, 15, and 30 minutes or 1 HR (for a one hour average).

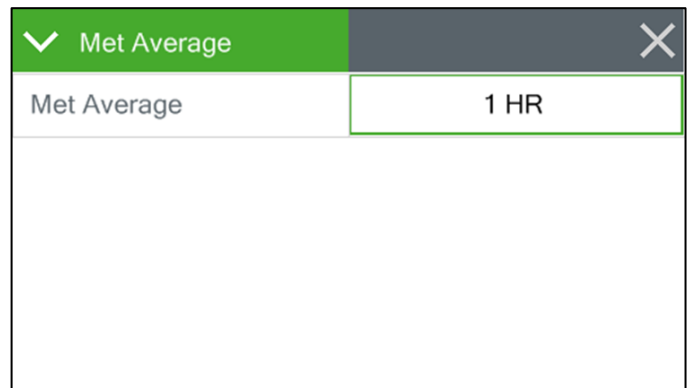

Figure 3-51 The Met Average Screens

#### **Warning: This setting will affect how long the memory will last before getting full!**

There are **14000 records** available in the memory. The memory capacity is shown below. When the memory gets full the BAM 1020 overwrites the oldest data. It is recommended that the MET SAMPLE period is set at the default value of 60 minutes unless a faster average is required for a particular met sensor application.

MET SAMPLE	Data Capacity
60 min	586 days
30 min	293 days
15 min	146 days
10 min	97 days
5 min	48 days
1 min	9 days

### 3.5.13 Analog Outputs

There are two analog output channels. They are located on the back panel as Analog Out 1 and Analog Out 2.

They represent the hourly concentration and standard concentration measurement, respectively. These two outputs are independently set to either 0-1.0, 0-2.5 or 0-5.0 VDC.

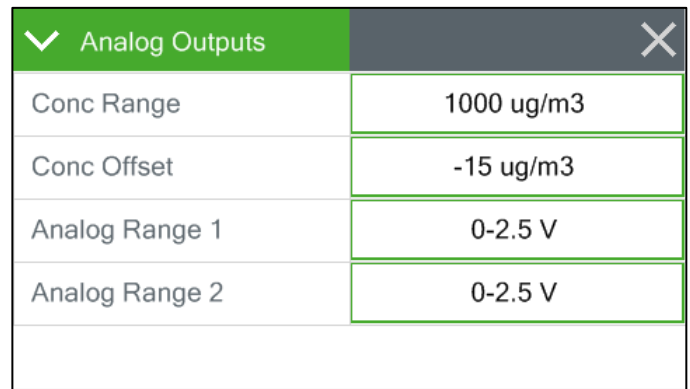

✓ Analog Outputs		✕
Conc Range	1000 ug/m3	
Conc Offset	-15 ug/m3	
Analog Range 1	0-2.5 V	
Analog Range 2	0-2.5 V	

Figure 3-52 The Analog Output Screen

While the output voltage is set independently, there is only one concentration range setting (the Conc Range field) and it is applied to both channels. The Conc Range field can be set to 100, 200, 500, 1000, 2000, 5000, or 10000  $\mu\text{g}/\text{m}^3$ . The default setting is 1000  $\mu\text{g}/\text{m}^3$ .

The offset for the concentration range (Conc Offset) can be adjusted to -15, -10, -5, 0, 5  $\mu\text{g}/\text{m}^3$ . It should be left at the default value of -15  $\mu\text{g}/\text{m}^3$  for most applications.

Regardless of the concentration units setting, the scaling and offset is always entered in  $\mu\text{g}/\text{m}^3$ .

### 3.5.14 Serial Ports

There are serial connections on the back of the BAM 1020. Each one serves a unique purpose in the communication options available for the monitor and each one is configured separately.

The RS-232 port will typically be used for direct connection to a PC or other RS-232 compatible device.

The RS-485 port will typically be used with the Met One CCS Modem option.

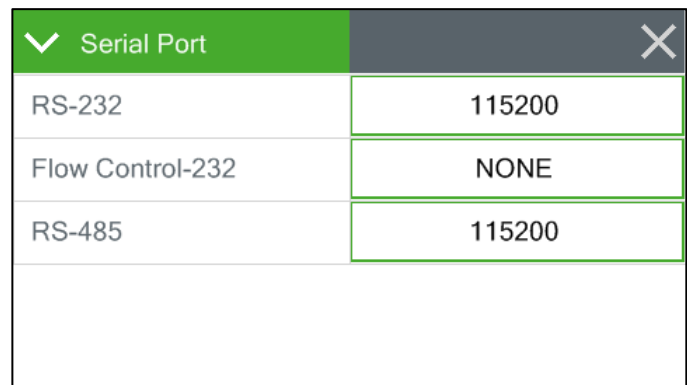

✓ Serial Port		✕
RS-232	115200	
Flow Control-232	NONE	
RS-485	115200	

Figure 3-53 The Serial Port Screen

The baud rate options are 2400, 4800, 9600, 19200, 38400, 57600, and 115,200. The default value for is 115,200 baud.

In some cases, remote access over Ethernet or modems may require flow control to compensate for slow or noisy connections. In these situations, the RS-232 serial connection can be configured to use XON/XOFF flow control. Flow control is set to NONE by default but can be changed using the Flow Control-232 selection box.

See Section 7.3 for more details about serial communications.

### 3.5.15 Modbus

The BAM 1020 can use the RS-232 or RS-485 serial connection, on the back panel for Modbus communications.

Use the Modbus Port field to set which ports will be the Modbus Slave Port:

Use the Modbus Address field to set a unique Modbus Slave address from 1 to 247.

✓ Modbus		✕
Modbus Port	RS-232	
Modbus Address	1	

Figure 3-54 The Modbus Screen

### 3.5.16 Ethernet

This screen allows for setting the IP Address, Subnet Mask, and Gateway, and DNS Server values to allow the BAM 1020 to communicate on a local area network using a standard Ethernet cable connected to a switch or router.

The values input here should be provided by the site IT department.

✓ Ethernet		✕
IP Address	0.0.0.0	
Subnet Mask	0.0.0.0	
Gateway	0.0.0.0	
DNS Server	0.0.0.0	

Figure 3-55 The Ethernet Screen

It is recommended to configure the BAM 1020 with a fixed IP address if using Ethernet communications. However, if needed, setting the IP address to 0.0.0.0 will configure the monitor for DHCP operation. The IP address port will always be 7500.

### 3.5.17 Ethernet Config

This screen is used to view the current Ethernet settings of the BAM 1020. In addition to the IP Address, Subnet Mask, Gateway, and DNS Server settings (see Section 3.5.16 for details on changing these values), the MAC Address of the BAM 1020 can also be viewed here. Be aware the IP address port will always be 7500.

Note that this screen is for display purposes only. No changes can be made on this screen.

✓ Ethernet Config		✕
IP Address	192.168.1.106:7500	
Subnet Mask	255.255.248.0	
Gateway	192.168.0.3	
DNS Server	18.3.18.3	
MAC Address	DE:AD:BE:EF:1F:5B	

Figure 3-56 The Ethernet Config Screen

### 3.5.18 Sound Volume

The touchscreen will beep every time a selection is made, and that volume may be adjusted in this screen. Set a value from 0 to 100 with 100 being very loud and 0 being no beep at all. Any changes made here will not be active until exiting this screen. The default setting is 10.

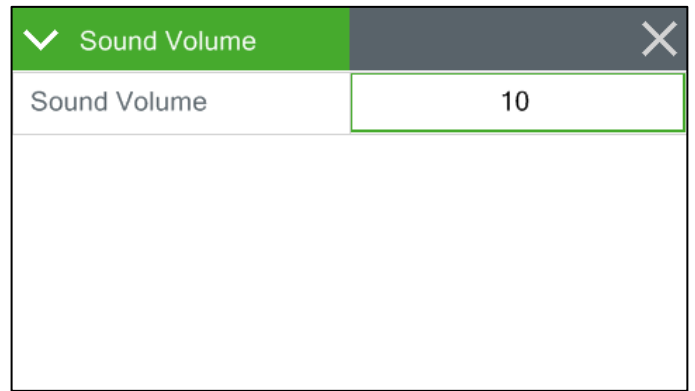

Figure 3-57 The Sound Volume Screen

### 3.5.19 Touch Calibration

If the touchscreen response seems inaccurate, the screen calibration may be adjusted using this menu option. Press the CALIBRATE button to begin the calibration process and then follow the instructions on the screen.

A five second countdown is displayed on each step. If it reaches zero, the test will be cancelled, and the display will return to the Setup menu.

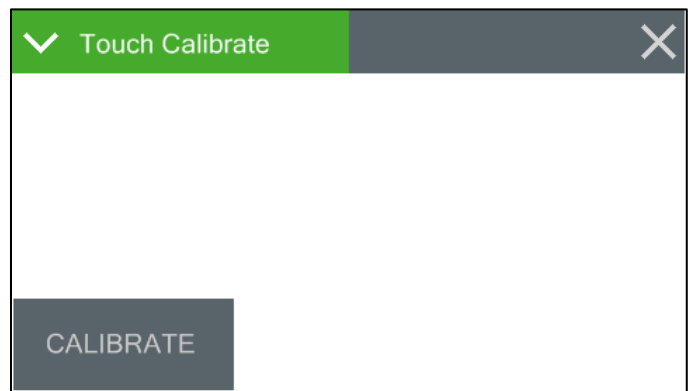

Figure 3-58 The Touch Calibrate Screen

### 3.5.20 Set Language

The BAM 1020 provides language options for its interface display. Use this screen to set a preferred language supported.

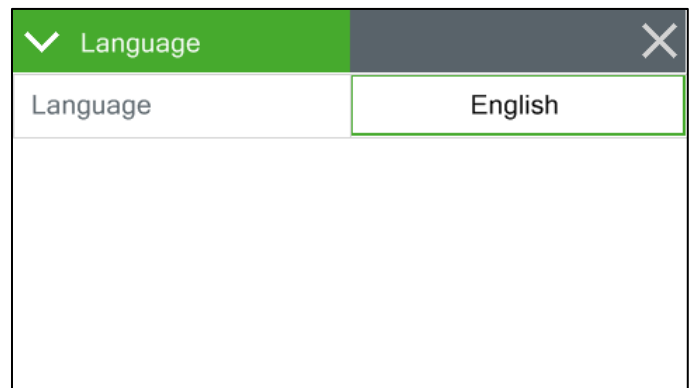

Figure 3-59 The Set Language Screen



### 3.6 Alarms Menu

This screen is used to view time-stamped alarm events. The most recent alarm will be displayed first.

Use the up and down arrow keys located at the bottom of the screen to scroll through the alarm log.

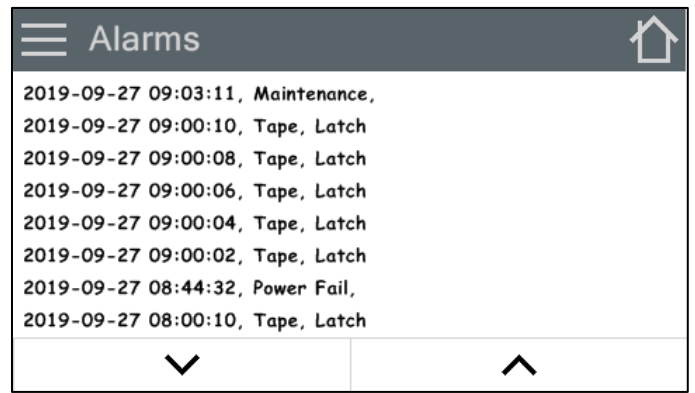

Figure 3-60 The Alarms Menu

## 4 INITIAL SETUP OF THE BAM 1020

This section describes the process for setting up and configuring the BAM 1020, as well as the basic steps required to put the BAM 1020 into operation. Some of the topics in this section will refer to other sections of this manual for more detailed information. It is assumed that the BAM 1020 is already installed and sited as described in Section 2. In some cases, it is useful to first set up the BAM 1020 on a test bench before deployment or installation in order to explore the functions and perform setups. The following steps for starting up the BAM 1020 are described in this section:

1. **Power on and warm up.**
2. **Become familiar with the user interface.**
3. **Load a roll of filter tape.**
4. **Perform a Self-Test.**
5. **Set the real-time clock and review the SETUP parameters.**
6. **Perform a leak check and a flow check.**
7. **Return to the top-level menu and wait for automatic start at the top of the hour.**
8. **View the OPERATE menus during the cycle.**

### 4.1 Power Up

The power switch is located on the back of the BAM 1020. Verify that the BAM 1020 external power supply, external vacuum pump, and the heater relay enclosure power cables are connected to the correct AC voltage, and that any electrical accessories are correctly wired before energizing the unit. (Section 2.6) When power is switched on, the unit will take about 15 seconds to boot up the touch screen display module, after which the main menu screen should appear. The unit will probably flash an error indicating that there is no filter tape installed.

### 4.2 Warm-up Period

The BAM 1020 must warm up for at least one hour before valid concentration data can be obtained. This is because the beta detector contains a vacuum tube which must stabilize. This also allows the electronics to stabilize for optimal operation. This applies any time the BAM 1020 is powered up after being off for more than a moment. Instrument setups and filter tape installation can be performed during the warm-up time. It is not uncommon to discard the first few hours of data after the equipment is powered up.

### 4.3 The Main Operate Screen

When the BAM 1020 is powered up it will display the Main Operate screen. This screen is the starting point for all functions of the BAM 1020 user interface. See Section 3.2 for a detailed explanation of the menu system interface.

## 4.4 Filter Tape Loading

A roll of Met One glass fiber filter tape must be loaded into the BAM 1020 for sampling. A roll of tape will last more than 60 days under normal operation. It is important to have spare rolls available to avoid data interruptions. Some agencies save and archive the used filter tape, although the used sample spots are not protected from contamination and are not marked to indicate the sample hour or site. Chemical analysis may be affected by the binder agent in the tape. Used filter tape should never be “flipped over” or re-used! This will result in measurement problems. Loading a roll of filter tape into the BAM 1020 is a simple matter using the following steps:

1. Turn on the BAM 1020. The BAM 1020 should automatically raise the sample nozzle.
2. Lift the rubber pinch roller assembly and latch it in the UP position.
3. Unscrew and remove the two clear plastic reel covers.
4. An empty core tube **MUST** be installed on the left (take-up) reel hub. This provides a surface for the used tape to spool upon. One plastic core tube is supplied to use with the first roll of tape. After that, use the empty core tube left over from the previous roll. *Never fasten the filter tape to the aluminum hub.*
5. Load the new roll of filter tape onto the right (supply) reel and route the tape through the transport assembly as shown in the drawing. Attach the loose end of the filter tape to the empty core tube with adhesive cellophane tape or equivalent.
6. Rotate the tape roll by hand to remove excess slack, then install the clear plastic reel covers.
7. Align the filter tape so that it is centered on all of the rollers. There are score marks on the rollers to aide in visually centering the tape.
8. **Unlatch and lower the pinch roller assembly onto the tape. The BAM 1020 cannot automatically lower the pinch rollers, and the it will not operate if the pinch rollers are left latched in the up position!**
9. Press the TENSION button in the Operate > Load Filter Tape menu. The BAM 1020 will set the tape to the correct tension and provide an alert if there was an error with the process. Exit the menu.

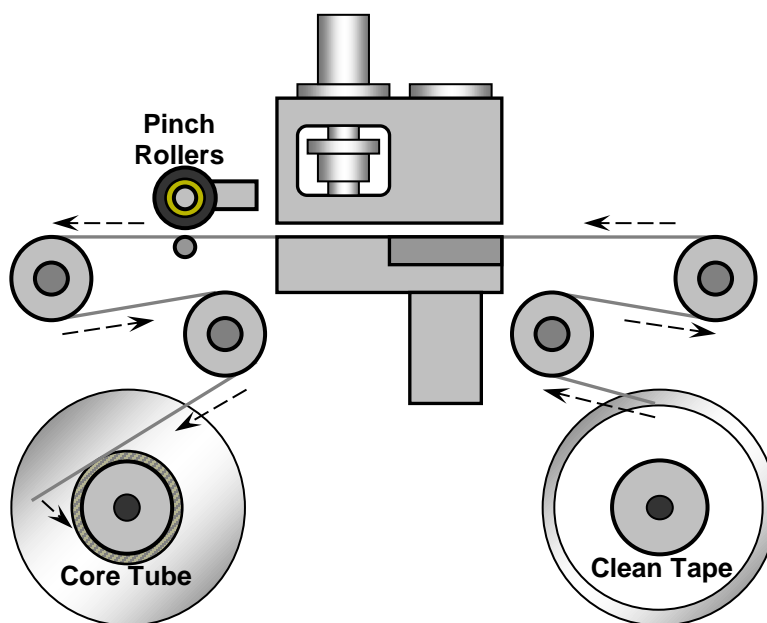
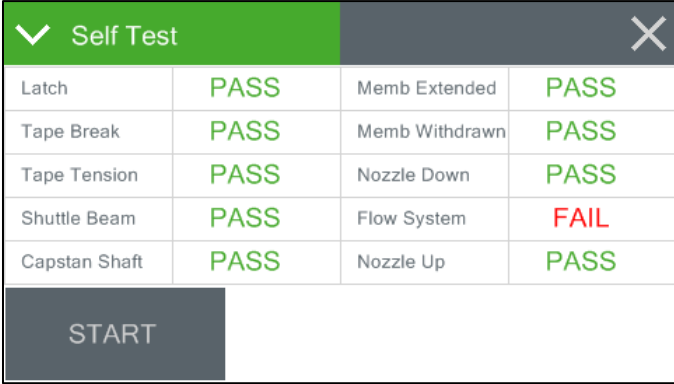

Figure 4-1 BAM 1020 Filter Tape Loading Diagram

## 4.5 Self-Test

The BAM 1020 has a built-in self-test function which automatically tests most of the tape control and flow systems of the BAM 1020. The self-test should be run right after each time the filter tape is changed, and it can also be used if the operator suspects a problem with the BAM 1020. More detailed diagnostic test menus are also available in the BAM, and those are described in the troubleshooting Section 6.

The self-test feature is located in the Test menu (see Section 0). Enter the Test > Self Test menu and press the grey START button to begin the test. The full sequence of tests will take a couple of minutes, and the BAM 1020 will display the results of each tested item with green PASS or red FAIL tag (see Figure 4-2). A blue TEST status indicates which test is currently being performed.



Self Test			
Latch	PASS	Memb Extended	PASS
Tape Break	PASS	Memb Withdrawn	PASS
Tape Tension	PASS	Nozzle Down	PASS
Shuttle Beam	PASS	Flow System	FAIL
Capstan Shaft	PASS	Nozzle Up	PASS

START

Figure 4-2 BAM 1020 Self-Test Status Screen

**Latch:** This will pass if the photo interrupter senses that the pinch rollers are unlatched (down) as in normal operation. It will fail if the roller assembly is latched in the up position. The tape cannot advance if the rollers are up!

**Tape Break:** The BAM 1020 will move the supply and take-up motors to create slack in the filter tape and look for proper operation of the tensioner photo interrupters.

**Tape Tension:** The BAM 1020 will tension the filter tape, and then check the condition of the tensioner photo interrupters.

**Shuttle Beam:** The BAM 1020 will attempt to move the shuttle beam left and right and will check the motion with a photo interrupter.

**Capstan Shaft:** The Capstan shaft moves the filter tape back and forth. The BAM 1020 will rotate the shaft forward and backwards to confirm the photo interrupter detects the shaft rotating.

**Memb Extended:** The BAM 1020 will attempt to extend the reference membrane and will confirm the motion with a photo interrupter.

**Memb Withdrawn:** The BAM 1020 will attempt to withdraw the reference membrane and will confirm the motion with a photo interrupter.

**Nozzle Down:** The BAM 1020 will attempt to lower the nozzle. It will check verify the nozzle motor has moved to the down position with a photo interrupter. It is possible for the nozzle to become stuck in the UP position, even if the nozzle motor has successfully moved to the DOWN position. For this reason, proper inlet alignment and nozzle O-ring maintenance is necessary.

**Flow System:** The BAM 1020 will attempt to turn the pump on and will then monitor the output on the flow sensor. This test takes about a minute and will fail if the pump is not connected.

**Nozzle Up:** The BAM 1020 will attempt to raise the nozzle and will verify the nozzle motor has moved to the up position with a photo interrupter.

#### **4.6 Initial Setup Settings Considerations**

The BAM 1020 comes pre-programmed with a wide array of default values for the settings which govern the measurement and calibration. Most of these setup values will not be changed since the default values are correct for most applications. Review the Setup Menus in Section 3.5 of this manual and decide if any values need to be changed. At the very least, review the following parameters:

1. Set the system clock (see Section 3.5.1). The BAM 1020 clock may drift as much as two minutes per month. It is important to check the clock at least once per month to ensure the samples are performed at the correct times.
2. Review the BAM Sample and Beta Count settings (see Section 3.5.2).
3. Review the Met Average period (see Section 3.5.12).
4. Review the Inlet Heater control settings (see Section 3.5.5).

#### **4.7 Initial Leak Check and Flow Check**

The BAM 1020 comes with factory-set flow calibration parameters which will allow the BAM 1020 to accurately control the 16.67 L/min sample flow system right out of the box. However, due to minor variations between different types of flow transfer standards, it is best to calibrate the flow system with a traceable flow audit standard upon initial deployment. Perform leak checks and flow checks/calibrations as described in Section 6.3.4. Become comfortable with these processes, as they will be performed on a routine basis.

#### **4.8 Starting a Measurement Cycle**

When the preceding setup steps of Section 4 have been completed, exit out to the main top level Operate menu. The "Status" line may display "MAINTENANCE" or other errors owing to performing setup and initialization sequences. This is normal and should be expected. The BAM 1020 will clear all alarms and start at the top (beginning) of the next hour and will continuously operate until commanded to stop.

The BAM 1020 will stop if the operator enters certain Test or Setup menus, but users will be provided a warning screen first. The BAM 1020 will also stop itself if a non-correctable error is encountered, such as broken filter tape or failed air flow.

## 5 THE MEASUREMENT CYCLE

This section describes the measurement and timing cycle of the BAM 1020 instrument. An understanding of the measurement is helpful for the effective operation and maintenance of the BAM 1020. For advanced information on the underlying theory and mathematics of the measurement see Theory of Operation, Section 9.

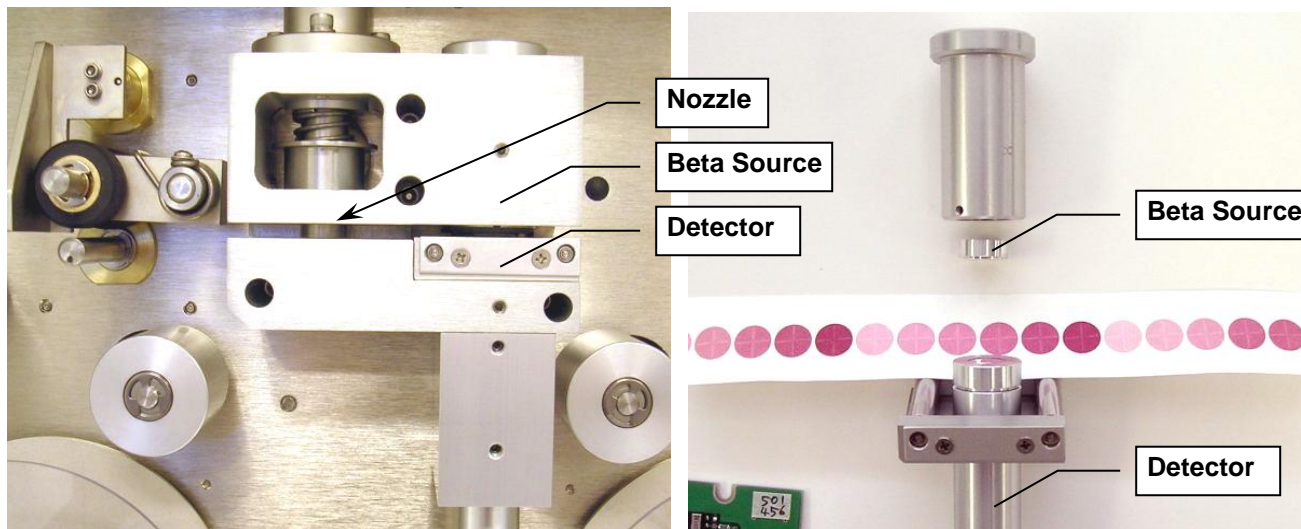

Figure 5-1 BAM 1020 Sample and Measurement Stations

### 5.1 The One-Hour Cycle Timeline

The BAM 1020 is almost always configured to operate on 1-hour cycles. The BAM 1020 has a real-time clock which controls the cycle timing. The COUNT TIME on the BAM 1020 is user selectable, but is generally set to 4 minutes for PM<sub>10</sub> measurement or to 8 minutes for PM<sub>2.5</sub> measurement. In the example timeline below the BAM 1020 makes an 8-minute beta measurement at the beginning and the end of each hour, with a 42 minute air sample period in between, for a total of 58 minutes. The other two minutes of the hour are used for tape and nozzle movements during the cycle. This timeline applies if the BAM 1020 is set for a COUNT TIME of 8 minutes, which is required for all EPA and EU designated PM<sub>2.5</sub> configurations.

When configured as a US-EPA designated equivalent method for PM<sub>2.5</sub>, COUNT TIME must be set to 8 minutes. If it is desired to operate the BAM 1020 as a non-designated method for PM<sub>2.5</sub> monitoring, the COUNT TIME may be set to 4, 6, or 8 minutes. When running the BAM 1020 as a US-EPA designated equivalent method for PM<sub>10</sub> COUNT TIME may be set to 4, 6, or 8 minutes. The total measurement cycle is 1 hour. The pump sampling time may be calculated by subtracting twice the COUNT TIME from 60 minutes and then subtracting an additional 2 minutes to allow for tape movement. Therefore, a COUNT TIME of 8 minutes would provide a pump sampling time of 42 minutes (60-8-8-2). **Note:** This cycle will be slightly altered if the BAM 1020 is operated in the special Early Cycle mode with an external data logger. See Section 7.

The example below provides an example of the timing of a measurement cycle with a COUNT TIME of 8 minutes.

1. **Minute 00:** The beginning of an hour. The BAM 1020 advances the filter tape forward one “window” to the next fresh, unused spot on the tape. This takes a few seconds. The new spot is positioned between the beta source and the detector, and the BAM begins counting beta particles through this clean spot for exactly eight minutes. (I<sub>0</sub>)
2. **~Minute 08:** The BAM 1020 stops counting beta particles through the clean spot (I<sub>0</sub>), and moves the tape exactly four windows forward, positioning that same spot directly under the nozzle. This takes a few seconds. The BAM 1020 then lowers the nozzle onto the filter tape and turns the vacuum pump on, pulling particulate-laden air through the filter tape on which I<sub>0</sub> was just measured, for 42 minutes at 16.67 liters per minute.
3. **~Minute 50:** The BAM 1020 turns the vacuum pump off, raises the nozzle, and moves the filter tape backwards exactly four windows. This takes a few seconds and puts the spot that was just loaded with particulate back between the beta source and the detector. The BAM begins counting beta particles through the now dirty spot of tape for exactly eight minutes (I<sub>3</sub>).
4. **~Minute 58:** The BAM 1020 stops counting beta particles through the dirty spot (I<sub>3</sub>). The BAM 1020 uses the I<sub>0</sub> and I<sub>3</sub> counts to calculate the mass of the deposited particulate on the spot and uses the total volume of air sampled to calculate the concentration of the particulate in milligrams or micrograms per cubic meter of air. The BAM then sits idle until the top of the next hour.
5. **Minute 60:** The beginning of the next hour. The BAM 1020 records the just-calculated concentration value to memory and sets the analog output voltage to represent the previous hour’s concentration. The BAM 1020 advances a new fresh spot of tape to the beta measurement area and the measurement cycle starts again.

## 5.2 Automatic Span Checks During The Cycle

While the vacuum pump is on and pulling air through the filter tape as described above the BAM 1020 performs a span check. The user may set up the BAM 1020 to perform the span check hourly, once per day, or not at all. The BAM 1020 also performs a stability test:

1. **Minute 08:** The BAM 1020 has just finished moving the clean spot to the nozzle and turned the pump on. There is another clean spot of filter tape upstream four windows, between the beta source and the detector. This same spot will stay there for the entire time the pump is on. The BAM 1020 begins counting the beta particles through this spot for exactly eight minutes. The measured value is recorded as  $I_1$ .
2. **Minute 16:** The BAM 1020 stops counting beta particles and extends the reference membrane between the beta source and the detector, directly above the spot of filter tape that was just measured. The reference membrane is an extremely thin film of clear Mylar held in a metal tongue. The membrane is of known mass density (mg/cm<sup>2</sup>). The BAM starts counting beta particles for eight minutes again, this time through the membrane *and* the filter tape spot at the same time. This value is recorded as  $I_2$ .
3. **Minute 24:** The BAM 1020 stops counting beta particles through the membrane, withdraws the membrane assembly, and calculates the mass density of the membrane.
4. **Minute 42:** (Eight minutes before the pump stops) The BAM 1020 counts the beta particles through the same spot again (without the membrane) for another eight minutes. This value is recorded as  $I'_1$ .

The mass density " $m$ " ( $\text{mg}/\text{cm}^2$ ) of the reference membrane calculated during this automatic process is compared to the known mass of the membrane; the Span Membrane (synonymous to *ABS*) value. During factory calibration, the actual mass of each individual span foil is determined and saved as the Span Membrane value of the BAM 1020 in which it was installed. Each measurement of  $m$  must match the Span Membrane value within  $\pm 5\%$ . If not, the BAM 1020 records a "D" alarm for that hour's data. Typically, the value of  $m$  is within a few  $\text{mg}/\text{cm}^2$  of the expected value. The Span Membrane value is unique to each BAM 1020, and can be found on the calibration sheet. Most membrane alarms are caused by a dirty membrane foil.

The stability measurements  $I_1$  and  $I'_1$  may be compared to determine if the beta counts have changed appreciably during the measurement cycle. Rapid changes in temperature, relative humidity or other factors may lead to this.

### **5.3 Filter Tape Use**

The BAM 1020 positions the filter spots very close to one another so as not to waste filter tape. Once each day at midnight, the BAM 1020 will skip a spot (there will not be a spot where one is expected to be). This is done to make it easier for the user to match the spot on the take up spool with the hour and the day the spot was generated if this is necessary to be done. Met One Instruments currently offers filter tape using part number 460180.



## 6 MAINTENANCE, DIAGNOSTICS and TROUBLESHOOTING

This section provides information about routine maintenance, identifying errors and alarms, and performing diagnostic tests on the BAM 1020. The TEST menu functions are also described in this section.

Met One Instruments, Inc. also publishes a comprehensive array of technical bulletins that covers additional information about subsystem troubleshooting, upgrades, and repairs. These are available in the “BAM Users” section of our website, or by e-mail request from the service department (see Section 1.2).

### 6.1 Met One Recommended Periodic Maintenance Table

Table 6-1 shows the recommended interval for the regular BAM 1020 maintenance, field checks, and service tasks. Special tools are not required for any of the routine BAM service tasks on less than yearly intervals. Met One Instruments, Inc. recommends the BX-308 and BX-344 kits for all non-routine service and repairs such as nozzle removal and detector tests. Complete instructions are included.

Maintenance Item	Period
Nozzle and vane cleaning.	Monthly
Leak check.	Monthly
Flow system check/audit.	Monthly
Clean capstan shaft and pinch roller tires.	Monthly
Clean PM10 inlet particle trap and PM2.5 cyclone particle trap.	Monthly
Download and save digital data log and error log.	Monthly
Compare BAM 1020 digital data to external analog data logger data, if used.	Monthly
Check or set BAM real-time clock.	Monthly
Replace filter tape roll.	2 Months
Run the SELF-TEST function in the TAPE menu.	2 Months
Download and verify BAM 1020 settings file.	Quarterly
Complete flow system calibration.	Quarterly
Completely disassemble and clean PM10 inlet and PM2.5 cyclone.	Quarterly
Replace or clean pump muffler.	6 months
Test filter RH, BP, and temperature sensors.	6 months
Test smart heater function.	6 months
Clean internal debris filter.	12 Months
Remove and check membrane span foil.	12 Months
Beta detector count rate and dark count test.	12 Months
Clean vertical inlet tube (BX-344 cleaning kit).	12 months
Test analog DAC output, if used.	12 Months
Replace lithium battery if necessary.	12 Months
Rebuild vacuum pump.	24 months
Replace nozzle O-ring.	24 months
Replace pump tubing, if necessary.	24 Months
Factory recalibration is not required except for units sent for major repairs.	---

**Table 6-1 BAM 1020 Recommended Maintenance Schedule**

## 6.2 Filter Sensor Tests

The BAM 1020 flow path contains temperature, humidity, and pressure sensors. These internal sensors are located just past the sample filter tape and are used to monitor and control the Smart Heater and tape loading. External sensor(s) monitor ambient conditions and are used for concentration calculations and controlling the sample flow rate.

This test menu will be used for testing the internal sensors located just past the filter tape in the flow system. See Section 3.4.6 for a brief description and location of the menu. When this screen is entered, the BAM 1020 will automatically turn on the pump and raise the nozzle to allow the filter sensors to equilibrate to ambient room conditions.

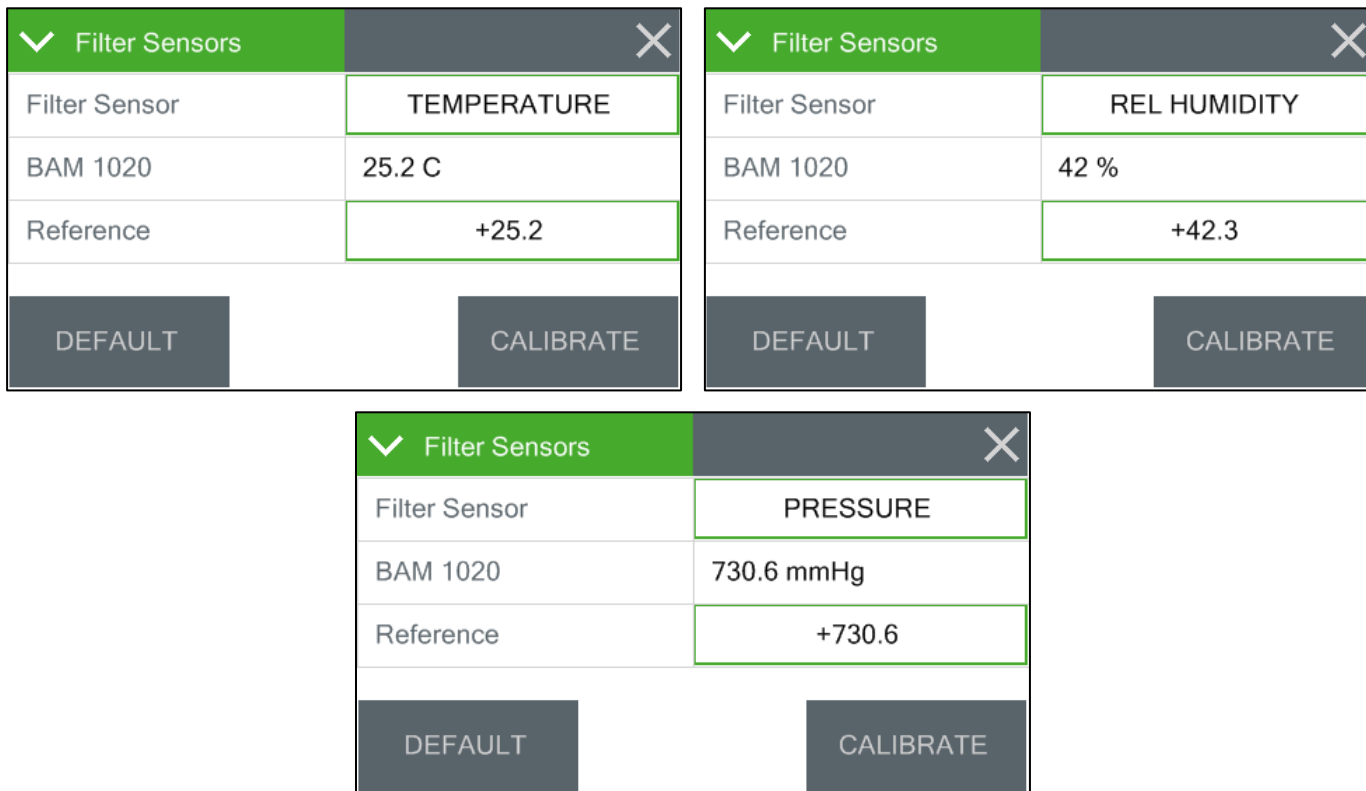

Figure 6-1 The Filter Sensors Screens

### 6.2.1 Filter Temperature Sensor Tests

The Filter Temperature (FT) sensor is used to monitor operation of the Smart Inlet Heater. When comparing the FT to ambient conditions, the FT value should be slightly higher than AT if the heater is operating correctly in idle mode, and significantly higher if the heater is in the ON state.

To check or calibrate the FT sensor, select TEMPERATURE in the Filter Sensor selection field. Allow the pump to run for at least 5 minutes (see note below) to allow the sensor to equilibrate. When fully equilibrated, the filter temperature should match ambient within **+/- 2 deg C**. To calibrate it, enter the ambient room temperature from the reference standard into the REFERENCE field and press the grey CALIBRATE button. The DEFAULT button can be used to revert to default calibrations and start over if difficulty is encountered.

**Note:** Never calibrate this sensor if the BAM inlet heater has been operating recently. The heater causes this sensor to measure higher than ambient conditions. See the notes about equilibrating or removing the filter RH sensor for calibrations below. Follow these steps for the filter temperature sensor, as well, if the heater has been operating.

## 6.2.2 Filter Humidity Sensor Tests

The Filter Relative Humidity (FRH) sensor measures the humidity of the sample air to control the Smart Inlet Heater system. The FRH value is used to set the inlet heater to the ON or idle state, as needed, to maintain the sample near or below the RH set point value. See Section 3.5.5.

To check or calibrate the FRH sensor, select REL HUMIDITY in the Filter Sensor selection field. The filter RH sensor should match ambient RH within **+/- 4%** when properly equilibrated. If the sensor fails, it usually reads something impossible like -25% or 135% RH.

**Important Equilibration Notes:** It is difficult to effectively correlate an ambient RH measurement to the filter RH reading, because the BAM has some self-heating from the Smart Heater which causes the filter sensor to measure significantly lower than ambient RH. For this reason, it is usually best to leave the factory default calibration alone, unless there is clear evidence that it needs to be calibrated. *If the filter RH sensor is calibrated without first being fully equilibrated to ambient, it will introduce a large artificial offset.*

For example: The ambient RH is 50%, but the filter RH sensor reads 20% due to inlet heat. If the filter sensor calibration is adjusted to that it matches 50%, this adds a +30% offset to all RH readings. Now the filter RH data values are all 30% too high and it looks like the inlet heater is not functioning and not regulating the sample RH when it actually is. In addition, the inlet heater may run at full power trying to achieve regulation to the set point.

**To equilibrate the sensor without removing it from the sample stream:** Enter the TEST > FILTER RH screen. The BAM will raise the nozzle and turn the pump on to pull room air past the RH sensor. Unplug the inlet heater and allow the BAM to cool completely to room conditions. This might take an hour or two, possibly more. Position the RH audit device as close as possible to the BAM sample nozzle during calibration.

**To remove the sensor from the flow system for calibration:** Unplug the inlet heater and remove the BAM case cover. Remove the black 3-port compression manifold from the flow path. It is located under the nozzle motor and holds the two filter sensors. This is easiest with tool 9627 from the BX-308 tool kit. Leave the sensors plugged into the circuit board. Do not touch the RH sensor element because it is ESD sensitive. Move the sensor manifold away from the BAM so that an accurate ambient RH value can be obtained. Enter the Test > Filter Sensors menu, select REL HUMIDITY, and allow the sensor to equilibrate for at least five minutes, then compare the BAM 1020 reading on the display to the reference RH device. To calibrate the sensor, enter the reference value into the Reference field on the display and press CALIBRATE to change the BAM value to match.

**The DEFAULT button can be used to remove all previous field calibrations from the sensor and restore the default factory calibration.** Do not press the CAL key immediately after pressing RESET or the value present in the REFERENCE field will be applied.

## 6.2.3 Filter Pressure Sensor Tests

The filter pressure sensor is used to monitor particulate loading on the filter tape. When comparing the filter pressure to ambient conditions while actively sampling, the filter pressure should be lower than ambient pressure as it is on the vacuum side of the filter tape. See the Filter Pressure alarm explanation in Section 3.5.10.

To check or calibrate the filter pressure sensor, select PRESSURE in the Filter Sensor selection field. The pump should turn immediately turn off. Allow the filter pressure sensor to equilibrate to ambient conditions for about 15 seconds and then compare the BAM 1020 pressure value to the audit device. It should match the ambient pressure within **+/- 10 mmHg**. To calibrate it, enter the ambient pressure from the reference standard into the REFERENCE field and press the grey CALIBRATE button.

## 6.3 Flow System and Flow Calibrations

### 6.3.1 Flow System Diagram

The BAM 1020 is designed to operate with an air flow rate of 16.67 liters per minute (L/min or LPM). The flow rate must be maintained at this value in order for the commonly used the EPA PM<sub>10</sub> inlet head (BX-802) and PM<sub>2.5</sub> cyclones (BX-806, BX-807, BX-808 or BX-809) to work effectively. Periodic airflow audits must be performed to ensure that the BAM 1020 maintains the 16.67 LPM flow rate.

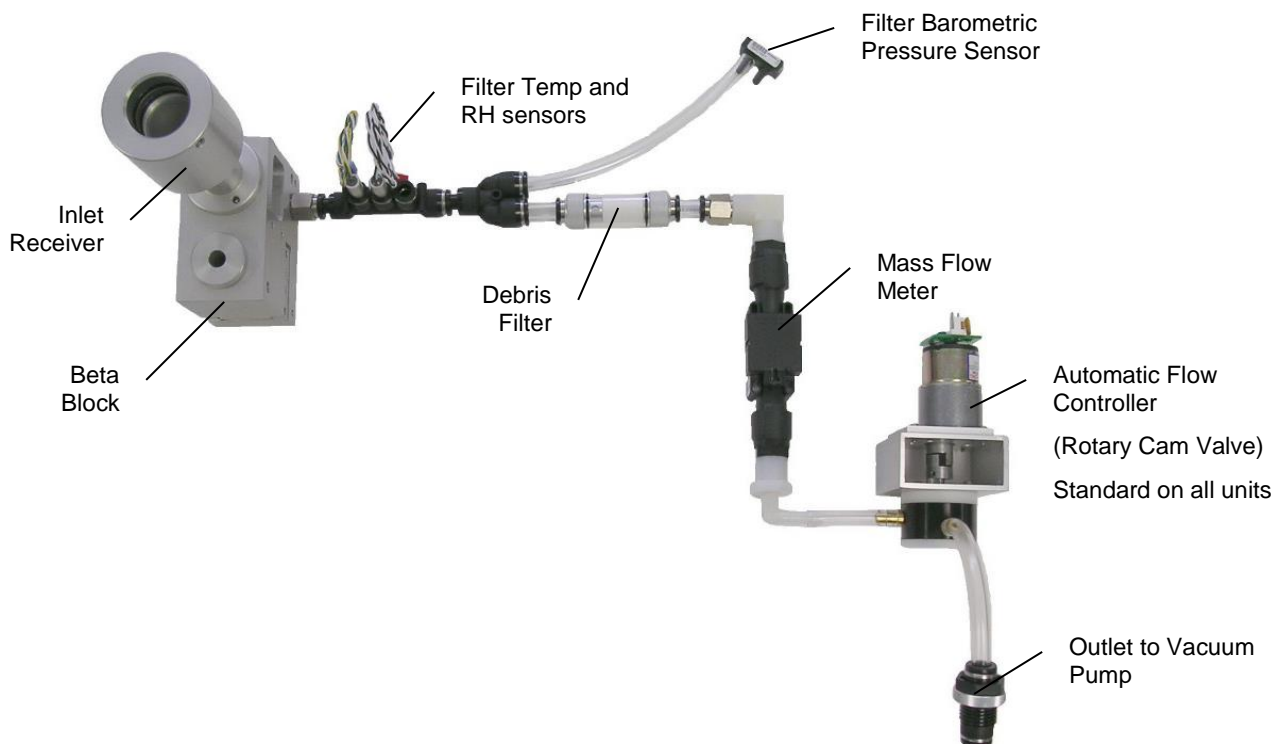

**Figure 6-2 The Complete BAM 1020 Flow Control System**

A BAM 1020 monitor has a mass flow sensor. The BAM 1020 is also equipped with an ambient temperature and barometric pressure sensor model BX-597A. Temperature and barometric pressure measurements are needed to convert mass flow into volume flow rate (LPM).

### 6.3.2 Flow Control

The BAM 1020 regulates flow to actual conditions (ambient temperature and barometric pressure).

Under Actual flow control, ambient temperature and barometric pressure measurements are used to convert the measured mass flow into volumetric flow (LPM). As the measured temperature and barometric pressure change, the mass flow controller will adjust its output to maintain constant volumetric flow.

### 6.3.3 Total Flow ( $Q_{TOT}$ ) and Flow Rate (LPM) Conversions

The  $Q_{TOT}$  measurement can be converted to LPM by multiplying the  $Q_{TOT}$  value by 1000, then dividing by the BAM Sample Time. For example, to determine what the flow rate was of a 42 minute sample with a  $Q_{TOT}$  value 0.700, perform the following calculation:

$$(Q_{TOT} * 1000) / \text{Sample Time} = (0.700 * 1000)/42 = 16.67 \text{ LPM}$$

### 6.3.4 About Leak Checks, Nozzle Cleaning, and Flow Checks

Met One Instruments recommends that users perform leak checks, nozzle and vane cleaning (if needed) and a flow check or calibration (if needed) at least once a month. Complete flow system maintenance typically requires less than 10 minutes to perform.

The best order for the monthly flow system checks is:

1. **As-found leak check.**
2. **Nozzle and vane cleaning.**
3. **As-left leak check.** (If a leak was corrected)
4. **Three-point flow check/audit and calibration if required.**

If an air leak is found, it could be caused by degraded O-rings, or an improper inlet tube to receiver connection. However, it *almost always* occurs at the interface between the nozzle and the filter tape due to debris buildup. There is normally an insignificant amount of leakage at the tape interface, but an excessive leak lets an unknown portion of the 16.67 L/min sample flow to enter the system at the leak point instead of the inlet. This could cause the total volume of air sampled through the inlet to be incorrect, and the resulting concentration data could be unpredictably biased. **The BAM 1020 cannot automatically detect a leak at the tape/nozzle interface because the airflow sensor is located downstream of the filter tape. Allowing a significant leak to persist may result in concentration data being invalidated!**

Routine leak checks and nozzle cleaning prevent any significant leaks from forming. Performing an as-found leak check before cleaning the nozzle or performing any service is needed for validating data collected since the last successful leak and flow check.

Even if the leak check value is found to be within acceptable bounds, the nozzle and vane should still be cleaned if any buildup or debris is noticed.

### 6.3.5 Leak Check Procedure

The basic leak check should always be performed first. If it passes, then there is no need to perform the advanced steps. However, if the basic check fails, the advanced leak check steps must be taken to locate the problem.

**NOTE:** *Only Met One Instruments, Inc. factory authorized tape should be used with the BAM-1020 monitor. Tape supplied by other vendors has not been tested or approved for use and any data collected using third party filter tape will not be considered valid.*

**Required Tools:** Leak Check Valve (Part No. BX-305 or included as part of the BX-302)

**Minimum Suggested Interval:** Monthly and whenever the filter tape is changed.

### 6.3.5.1 Basic Leak Check

Use the following steps to perform the basic leak check:

1. Go to the Test > Leak Test menu. This will stop the current sample if one is in progress.
2. Remove the PM10 size selective inlet from the sample tube and install the BX-305 leak check valve (or BX-302 zero filter). If a PM2.5 cyclone is being used, it should be left in place and included in the leak check. Verify that the leak valve is in the open position.
3. Press the PUMP ON button. The BAM-1020 will automatically lower the nozzle (if needed) and start the pump. The button should now read PUMP OFF.
4. Allow sufficient time for the flow to stabilize at 16.67 LPM on the BAM-1020 display and then press the LEAK ON button. Verify the text of the button changes to LEAK OFF.
5. Turn the BX-305 leak valve on the inlet to the closed position as shown in Figure 6-3.



Figure 6-3 BX-305 Leak Check Valve Installed on Inlet Tube

6. The pump flow rate should drop below 1.5 LPM.
  - a. If the flow rate is 1.5 LPM or less, the leak check is satisfactory. Proceed to step 7.
  - b. If the flow rate is greater than 1.5 LPM, the leak check fails. Proceed to step 7 and then repeat the leak test after completing step 11. If it fails a second time, go to Section 6.3.5.2.
7. Slowly open the BX-305 valve to restore normal flow through the BAM-1020.
8. Press the PUMP button to turn off the pump and then go to the Test > Tape Sensors menu.
9. Advance the tape forward by pressing the grey FORWARD button until the last sample spot is clearly visible.
10. Inspect the last sample spot on the tape roll. Examine it closely for any abnormal deformation or holes. The presence of abnormalities indicates debris build up at that location of the nozzle / vane interface. These indicate areas of the interface that may require additional cleaning. Note that in low concentrations the sample spot may not be easily located.

11. Remove the tape and thoroughly clean the nozzle / vane interface as instructed in Section 6.3.6. Pay particular attention to areas shown to have build-up described step 10 above.
12. Reinstall the filter tape as directed in Section 4.4. If step 6 failed, repeat the above leak check procedure now. If step 6 passed, continue on to step 13.
13. Exit to the Main Menu
14. Remove the BX-305 and replace the PM<sub>10</sub> size selective inlet.
15. Resume normal sampling operations.

### 6.3.5.2 Advanced Leak Checks

If the basic leak check detailed in Section 6.3.5.1 fails, the following procedures will isolate the problem.

**Required Tools:** Leak Check Valve (Met One Instruments Part No. BX-305 or BX-302)  
Nozzle Seal Tool (Part No. 7440)

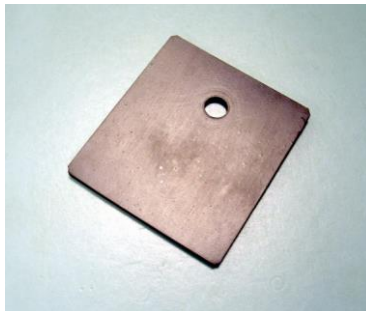

Figure 6-4 7440 Leak Isolation Shim

#### 6.3.5.2.1 Total System Leak Test

This procedure will create a positive seal at the nozzle / vane interface. With this seal in place, the rest of the flow system can be tested for leaks.

The following procedure assumes steps 1 through 6 in Section 6.3.5.1 have just been completed and a flow rate of greater than 1.5 LPM was found.

1. Go to the Test > Leak Test menu, if not already there.
2. If running, press the PUMP button to turn off the pump. Slowly open the BX-305 valve and then press the NOZZLE UP button to raise the nozzle.
3. Remove the filter tape from beneath the nozzle and insert the Nozzle Seal Tool with the hole positioned beneath the nozzle. See Figure 6-5.



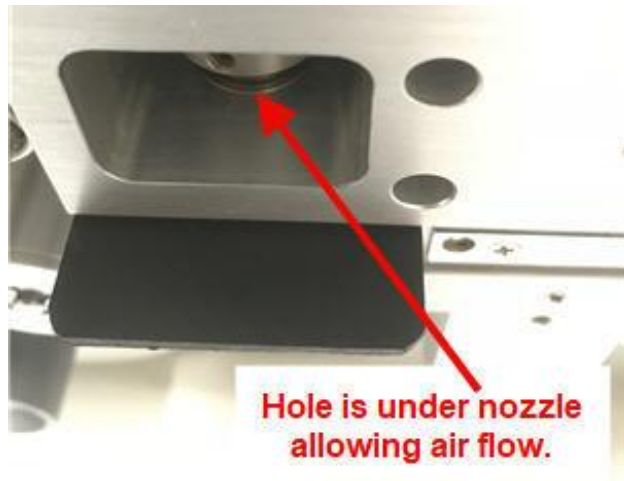

**Figure 6-5 Nozzle Seal Tool with Hole Under the Nozzle**

4. Verify the BX-305 valve is still mounted on the inlet and is in the open position.
5. In the Test > Leak Test menu. Press the PUMP ON button. The BAM-1020 will automatically lower the nozzle and start the pump.
6. Allow sufficient time for the flow to stabilize at 16.67 LPM on the BAM-1020 display and then press the LEAK ON button. Verify the button text changes to read LEAK OFF.
7. Turn the BX-305 leak valve on the inlet to the closed position as shown in Figure 6-3.
8. The pump flow rate should drop below 0.3 LPM.
  - a. If the flow rate is 0.3 LPM or less, the leak check is satisfactory. The high flow rate observed during the basic leak test is located at the nozzle / tape interface. Proceed to Section 6.3.5.2.3.
  - b. If the flow rate is greater than 0.3 LPM, then there is a leak somewhere in the system. Go to Section 6.3.5.2.2 to locate the leak.

### **6.3.5.2.2 Lower Leak Test**

This procedure will split the flow system at the nozzle / vane interface. With this seal in place, only the portion of the flow system downstream of this location will be placed under vacuum and tested for leaks.

The following procedure assumes the steps listed in Section 6.3.5.2.1 were performed and a leak of greater than 0.3 LPM was found.

1. If running, press the PUMP OFF button to turn off the pump. Then, press the NOZZLE UP button to raise the nozzle.
2. Rotate the Nozzle Seal Tool so that the solid portion of the tool is positioned beneath the nozzle. See Figure 6-6.



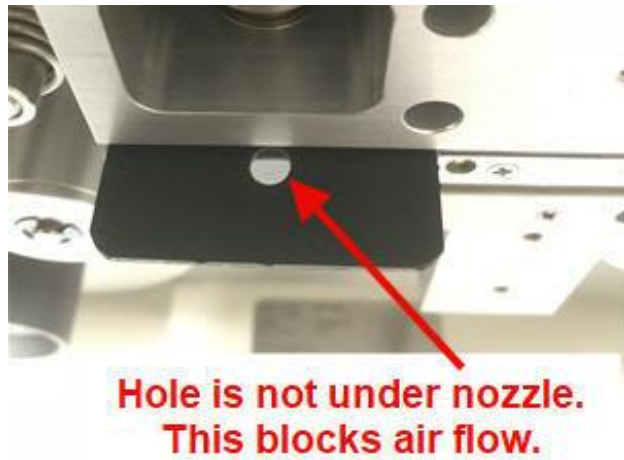

**Figure 6-6 Nozzle Seal Tool with Solid Side Under the Nozzle**

3. Press the grey LEAK ON button. The BAM-1020 should automatically lower the nozzle and start the pump.
4. The pump flow rate should drop below 0.3 LPM.
  - a. If the flow rate is 0.3 LPM or less, the leak check is satisfactory. This confirms that the leak is above the nozzle. Investigate all mating connections and O-rings in the flow path before the nozzle / vane interface to locate and correct the leak.
  - b. If the flow rate is greater than 0.3 LPM, then there is a leak downstream of the nozzle. Investigate all mating connections and O-rings in the flow path after the nozzle / vane interface to locate and correct the leak.
  - c. Once resolved, repeat the steps listed in Section 6.3.5.1 to verify the flow system integrity.

### **6.3.5.2.3 Filter Tape Leak Test**

Use this procedure to assess the actual leak rate at the nozzle / tape interface. It is assumed that the Basic Leak Check and the Total System Leak Test have both already been performed and a high flow rate (greater than 1.5 LPM) at the nozzle / tape interface was found. It is also assumed that the filter tape is still not installed.

**Required Tools:** Certified Calibration Transfer Standard (CTS) such as the BX-307  
Nozzle Seal Tool (Part No. 7440)  
Filter Tape (Part No. 460180)

1. Remove the BX-305 from the sample tube and install the calibration transfer standard (CTS).
2. Navigate to the Test > Leak Test menu.
3. The Nozzle Seal tool may already be installed with the hole positioned beneath the nozzle (see Figure 6-5). If this is not the case, press the NOZZLE UP button to raise the nozzle (if needed), position the sealing tool in this configuration, and then lower the nozzle.
4. Press the PUMP ON button to start the pump.

5. Allow at least 2-3 minutes for the flow to fully stabilize. When the flow rate stabilizes, write down the CTS flow rate value. This is the “Without Tape” value.  
**NOTE:** *If after 5 minutes, the flow still has minor fluctuations, estimate the average flow rate and use that for the “Without Tape” value.*
6. Stop the pump and raise the nozzle.
7. Remove the Nozzle Seal Tool.
8. Place a three-inch-long piece of filter tape directly below the nozzle.
9. Press the NOZZLE DOWN button to lower the nozzle.
10. Press the PUMP ON button to start the pump.
11. When the flow rate stabilizes, write down the CTS flow rate value. This is the “With Tape” value.
12. Stop the pump and raise the nozzle.
13. Remove the strip of filter tape.
14. Subtract the “With Tape” value from the “Without Tape” value using the following equation:  

$$\text{WithoutTape} - \text{WithTape} = \text{LeakRate}$$

The result should be a positive value of 0.3 LPM or less. A typical example might look like this:  

$$16.71 \text{ LPM} - 16.58 \text{ LPM} = 0.13 \text{ LPM}$$

  - a. If the difference is 0.3 LPM, or less, the leak test passes. Record the results (as needed), remove all test equipment, and resume normal sampling operations.
  - b. If the difference is greater than 0.3 LPM, an out of tolerance leak exists at the nozzle / tape interface. Thoroughly clean the nozzle and vane area and then perform this test again. Repeat this test. If after a couple of attempts this test still fails, contact the Met One Instruments, Inc. service department (see Section 1.2) for assistance.

Troubleshooting Section 6.7 contains additional tips for resolving leaks in the flow system.

### 6.3.6 Nozzle and Vane Cleaning Procedure

The nozzle and tape support vane (located under the nozzle) must be inspected regularly and cleaned as needed in order to prevent leaks at the interface between these parts and the filter tape. We recommended that the nozzle and vane be inspected monthly for tape build up. Some sites may require a more frequent inspection and cleaning interval. BAM 1020 monitors operated in hot, humid environments may require more frequent nozzle and vane cleaning. When the nozzle and vanes are not regularly cleaned filter tape debris may build up. This can lead to pin holes being punched through the filter tape which can in turn cause flow leaks and erroneous beta ray measurement. Use the following steps to clean the nozzle and vane parts:

1. Latch up the tape pinch rollers, and raise the nozzle in the Test > Leak Test menu. Slide the filter tape out of the slot in the beta block nozzle area. It is not necessary to completely remove the filter tape from the BAM 1020.
2. With the nozzle up, use a small flashlight to inspect the vane. Any debris will usually be visible. Clean the vane surface with a cotton-tipped applicator and deionized water or isopropyl alcohol. Hardened deposits may have to be carefully scraped off with the wooden end of the applicator. Take care not to damage the vane!

3. Press the NOZZLE DOWN button to lower the nozzle. Lift the nozzle with fingertip pressure and insert another wet cotton applicator between the nozzle and the vane. Let the nozzle press down onto the swab with its spring pressure. Using thumbs or fingertips, rotate the nozzle while keeping the swab in place (see Figure 6-7). A few rotations should clean the nozzle lip.
4. Repeat the nozzle cleaning until the swabs come out clean, then inspect the nozzle lip and vane again, looking for any burrs which may cause tape damage.

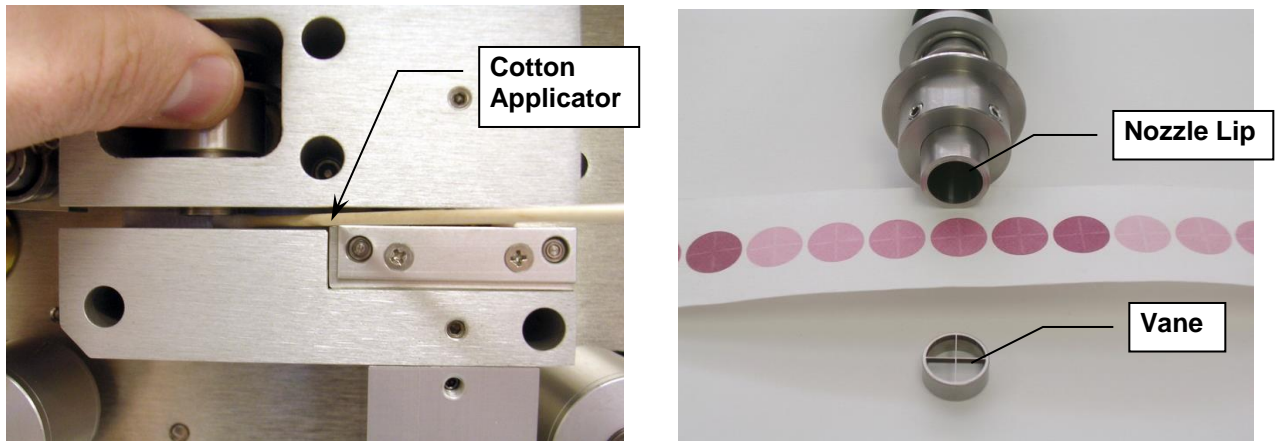

**Figure 6-7 Nozzle and Vane Cleaning, and Disassembled View**

Figure 6-8 shows the difference between good and bad filter tape spots. The tape on the left is from a properly operated BAM 1020 with a clean nozzle and vane. The dust spots have crisp edges, are perfectly round, and are evenly distributed.

The tape on the right is from a unit which has a leak. A spot of debris has built up on the vane and is punching a pin-hole at the edge of each spot. These holes can allow beta particles to get through unattenuated which can lead to erroneous concentration measurements. The spots also show a “halo” effect due to air leaking in around the edge because the nozzle is not sealing correctly. These faults are easily corrected and prevented by keeping the nozzle and vane clean.

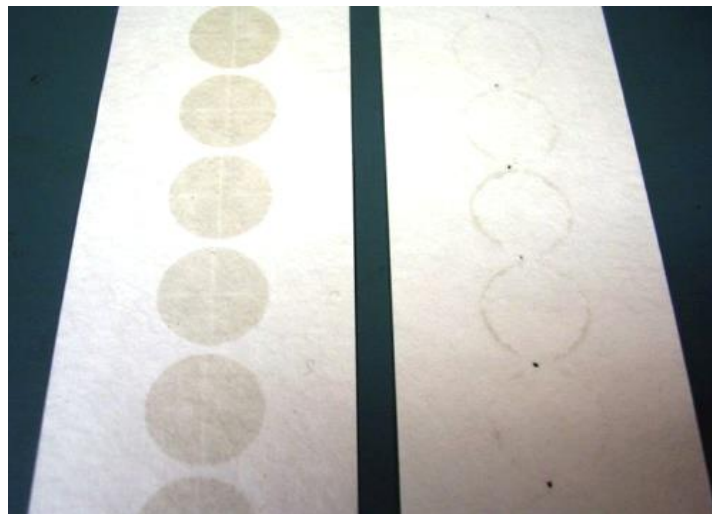

**Figure 6-8 BAM 1020 Hourly Filter Tape Spots**

### 6.3.7 Field Calibration of the Flow System

Flow calibrations, checks, or audits on the BAM 1020 are very fast and easy. The BX-597A ambient temperature sensor must be connected. Perform a leak check and nozzle cleaning before performing any flow calibrations.

Because the BAM 1020 utilizes both ambient temperature and ambient pressure in the calculation of the flow rate, these two parameters must be calibrated before the flow rate itself may be calculated.

If a flow audit is desired (and not a full calibration) the same procedure detailed in this section is followed, but no changes are made; the results are observed and recorded only. A flow audit confirms operation of the flow system without making any alterations. This may be necessary to validate collected data.

During verification of the BAM 1020 flow control system, the following acceptance criteria should be maintained.

Parameter	Acceptance Criteria
Flow Rate	± 2% of transfer standard
Ambient Temperature	± 2° C of transfer standard
Barometric Pressure	± 10 mmHg of transfer standard

**Table 6-2 BAM 1020 Flow Audit and Calibration Acceptance Criteria**

#### 6.3.7.1 Field Calibration of Ambient Temperature

Calibration of the ambient temperature sensor is accomplished in the Test > Ambient Temp screen (see Section 3.4.2). Use the following steps to verify and calibrate the ambient temperature sensor.

1. Make certain that the BAM 1020 has warmed up for at least 60 minutes prior to performing calibrations. Also, allow the calibration transfer standard (CTS) to equilibrate to ambient conditions for a minimum of 30 minutes.
2. Go to the Test > Ambient Temp menu. This will stop the current sample, if one is in progress.
3. Compare the BAM 1020 value displayed and the CTS temperature reading.
4. If the BAM 1020 temperature sensor exceeds the criteria listed in Table 6-2, press the grey DEFAULT button to remove any previous offsets.
  - a. If the temperature now passes, go to step 6.
  - b. If the temperature still needs to be adjusted, press the green bordered value box and the numerical entry keypad will be displayed. Enter the CTS value in the Standard field and press OK to return to the Ambient Temperature screen. Press the grey CALIBRATE button to enter the new calibration offset.
5. Compare the BAM 1020 value and the CTS temperature reading again and verify they are now within specifications.
6. Return to the Test menu.

#### 6.3.7.2 Field Calibration of Ambient Pressure

Calibration of the ambient pressure sensor is accomplished in the Test > Ambient Pressure screen (see Section 3.4.3). Use the following steps to verify and calibrate the ambient pressure sensor.

1. Make certain that the BAM 1020 has warmed up for at least 60 minutes prior to performing calibrations. Also, allow the calibration transfer standard (CTS) to equilibrate to ambient conditions.

2. Go to the Test > Ambient Pressure menu. This will stop the current sample if one is in progress.
3. Compare the BAM 1020 value displayed and the CTS pressure reading.
4. If the BAM 1020 pressure sensor exceeds the criteria listed in Table 6-2, press the grey DEFAULT button to remove any previous offsets.
  - a. If the pressure now passes, go to step 6
  - b. If the pressure still needs to be adjusted, press the green bordered value box and the numerical entry keypad will be displayed. Enter the CTS value in the Standard field and press OK to return to the Ambient Pressure screen. Press the grey CALIBRATE button to enter the new calibration offset.
5. Compare the BAM 1020 value and the CTS pressure reading again and verify they are now within specifications.
6. Return to the Test menu.

### 6.3.7.3 Field Calibration of Flow Rate

Calibration of the flow rate is accomplished in the Test > Flow Calibration screen (see Section 3.4.4). Use the following steps to verify and calibrate the BAM 1020 flow sensor.

1. Make certain that the BAM 1020 has warmed up for at least 60 minutes prior to performing calibrations. Also, allow the calibration transfer standard (CTS) to equilibrate to ambient conditions for a minimum of 30 minutes.
2. Go to the Test > Flow Calibration menu. This will stop the current sample if one is in progress.
3. Remove the size selective inlet(s) from the sample tube and install the CTS, if not already installed. Allow the unit flow reading to equilibrate with no flow for 30 seconds.
4. Calibrate the Zero Flow rate, if not 0.00 LPM, by pressing the ZERO button. Press CONTINUE.
5. Note: The DEFAULT button on the FLOW Calibration screen can be used to revert to default calibrations if difficulty is encountered. Pressing DEFAULT will remove existing calibration offsets for all three flow settings, and steps 6 - 14 must be performed to recalibrate flow rates.
6. Press the green bordered Set Point value box to display the flow rate test set point selections.
7. Select the 15.00 LPM set point and then press the OK button. The display will return to the Flow Calibration screen and flow will adjust to the selected flow set point.
8. Allow the BAM 1020 and CTS reading to stabilize (at least one minute) and then compare the BAM 1020 flow measurement and CTS flow reading.
9. Press the green bordered value box and the numerical entry keypad will be displayed. Enter the CTS value in the Standard field and press OK to return to the Flow Calibrate screen.
10. Press SET to apply the change. Note: When setting the 16.67 LPM flow rate, the SET option will change to read CALIBRATE.
11. The BAM 1020 flow rate will re-adjust. Allow the BAM 1020 and CTS reading to stabilize.
12. Verify the flow rate meets the criteria listed in Table 6-2
13. Repeat steps 5 through 11 above for the 18.30 LPM flow rate.
14. Repeat steps 5 through 11 above for the 16.67 LPM flow rate.
15. Return to the Main Operating Screen and remove the CTS from the inlet tube and replace the size selective inlet(s).
16. Resume normal sampling operations.

## 6.4 BAM 1020 Error and Alarm Descriptions

In the event a measured parameter or sequence is not within design specification, the BAM 1020 will generate an alarm. These alarms can be monitored via the alarm log, output files or the alarm relay. A list of alarms is detailed below.

An alarm is indicated and logged at the time it occurs. The resolution time is not recorded. See Section 3.6 for an explanation of viewing alarms through the BAM 1020 panel display.

**Note:** If multiple errors occur in the same data period, the stored alarm code will be the sum of the two individual codes. The letter code is the equivalent to the previous revision BAM 1020 (Generation 2).

**Note:** In general, any error which prevents the BAM 1020 from making a valid, hourly concentration measurement will also cause the digital concentration value to be stored as a full-scale value in order to indicate invalid data. In most cases, critical errors will also force the analog output to full-scale.

To determine which codes are being summed, note the largest code number that is less than the value stored. This will be the first code being summed. Subtract that from the stored value to determine the second code. Repeat this process until all codes are known. For example, if 264 is stored, the largest code beneath that value is 256. The difference between 264 and 256 is 8. This means the two codes are 256 and 8.

Code	Description	Error/Alarm Description
<b>512 M</b>	<b>Maintenance Alarm</b>	This alarm almost always indicates that the sample cycle was stopped because someone entered a SETUP or TEST menu for calibration or testing purposes. Maintenance flags always cause the digital concentration value to go full-scale for that hour, because the sample cycle was not finished.
<b>256 I</b>	<b>Internal Error</b>	The "I" error is rare and indicates that an error occurred in the BAM concentration, mass, span, or stability calculation which prevented the generation of a valid concentration value. The digital error log will indicate which of these calculations has failed. The concentration value is set to full-scale due to invalid data. This may indicate a problem in the digital circuitry.
<b>128 L</b>	<b>Power Failure or Processor Reset</b>	This error occurs if AC input power is lost even momentarily, or if the power switch is turned off. Frequent "L" errors usually indicate poor quality AC power. If frequent power errors occur even when the BAM 1020 is connected to a UPS backup system, contact Met One Instruments for instructions on possible power supply upgrades.  Anything that causes the microprocessor to reset will also result in an "L" error, such as low CPU voltage, bad connections on the internal DC power harness, or in rare cases electrical interference. All power failure errors cause the digital concentration value to go full-scale.
<b>64 R</b>	<b>Membrane Timeout</b>	This error indicates that the span reference membrane assembly may not be mechanically extending or withdrawing properly. The error is generated if photosensors S2 and S3 never change state after 15 seconds despite drive commands to the membrane motor. The digital error log will indicate which photosensor timed out. It may be a simple sensor/flag alignment problem that can be identified and corrected using the Test > Membrane Sensors menu. However, if the span foil assembly is stalled in a partially extended position, it could block the beta signal and prevent valid data collection.

<p style="text-align: center;"><b>32 N</b></p>	<p style="text-align: center;"><b>Nozzle Error</b></p>	<p>This error indicates that the nozzle motor is not operating correctly. The error is triggered if photosensors S4 and S5 never change state within 12 seconds, despite drive commands to the nozzle motor. The concentration value is set to full-scale if the nozzle motor or sensors have failed. The digital error log will indicate which photosensor timed out.</p> <p><b>Important Note:</b> The nozzle sensors watch the motor cam rotation, not the actual action of the nozzle itself, so it is technically possible for the nozzle to become stuck in the UP position even if the motor and sensors indicate no error. This could result in a massive flow leak and useless data with no errors or alarms being generated! Proper maintenance of the nozzle O-ring and proper inlet alignment prevent this.</p>
<p style="text-align: center;"><b>16 F</b></p>	<p style="text-align: center;"><b>Flow Error</b></p>	<p>Flow errors can occur due to a fault with the flow controller, the flow sensor, or the vacuum pump. See Section 6.7 for troubleshooting suggestions. The digital error log contains the exact subcategory which generated the alarm.</p> <p>The following minor flow alarms occur when a parameter was out of bounds, but the sample was not stopped. Concentration data is still stored normally</p> <ul style="list-style-type: none"> <li>• <b>5% out-of-regulation</b> - Flow &gt; 5% out of regulation for more than 5 minutes.</li> <li>• <b>AT Failure</b> – One minute average of the AT sensor was within 1 degree of the sensor min or max range. May occur in extreme cold or hot environments.</li> <li>• <b>Internal or External BP Failure</b> – One minute average of the barometric pressure sensor exceeded the min or max range of the BP sensor.</li> <li>• <b>Internal RH Failure</b> – One minute average of the filter RH sensor exceeded the min or max range of the FRH sensor</li> </ul> <p>The following critical flow errors result in the sample being terminated and the concentration data being set to full-scale or as configured in the Setup &gt; Alarms menu (see Section 3.5.10).</p> <ul style="list-style-type: none"> <li>• <b>AT Disconnected</b> - Missing or incorrectly connected AT sensor.</li> <li>• <b>Pump Off Failure</b> - Flow sensor indicates &gt;5 L/min with the pump turned off.</li> </ul> <p>This critical flow error results in the sample being terminated prematurely and the concentration being calculated with a smaller sample volume of air.</p> <ul style="list-style-type: none"> <li>• <b>Flow Failure</b> - Flow &gt; 10% out of regulation for more than 1 minute.</li> </ul>
<p style="text-align: center;"><b>8 P</b></p>	<p style="text-align: center;"><b>Filter Pressure Alarm</b></p>	<p>This error indicates that the pressure drop across the filter tape has exceeded the limit set by the “Filter Pressure” value and is often due to heavy particulate loading. The sample will stop early when this occurs and will make the concentration calculation based on the partial volume, then wait for the next hour. This feature is designed to stop the sample early if the vacuum capacity of the pump is about to be exceeded, before flow errors occur. The pump cycle must run for at least 5 minutes before a pressure drop alarm event can occur. See Section 3.5.10.</p>
<p style="text-align: center;"><b>4 D</b></p>	<p style="text-align: center;"><b>Membrane Deviation Alarm</b></p>	<p>This error indicates that the reference membrane span check measurement for that hour was out of agreement with the expected value (<b>Span Membrane</b>) by more than ±5%. These alarms are often caused by a dirty or damaged membrane foil. If the foil is clean and undamaged, the alarm could indicate that the beta detector tube itself is noisy or beginning to wear out, or that the membrane holder is not extending and withdrawing fully. These alarms do not prevent the BAM from storing a valid concentration for the sample hour because the particulate mass is a completely separate measurement, but the alarm should be investigated and resolved in order to ensure proper beta detector operation.</p>



<b>2 C</b>	<b>Count Error</b>	<p>This error indicates that the beta particle counting system is not operating properly and is activated if the beta count rate falls below 10,000 counts/4-minutes during any of the mass, membrane, or stability measurements. The 4-minute beta count rate through clean filter tape is usually more than 800,000 counts. This rare error occurs if the beta detector, high voltage, or digital counter has failed or if the beta signal is physically obstructed. This alarm sets the concentration value to full-scale.</p>
<b>1 T</b>	<b>Tape System Error</b>	<p>The tape error usually indicates that the filter tape is has run out or broken. It occurs if the right spring-loaded tensioner (tape roller nearest to the detector) is at the far left limit of its travel. In this case, tape break photosensor S6 is OFF continuously, despite drive commands to the tape reel motors and the capstan motor. The tape error is also generated if the pinch rollers are latched in the up position when a new sample hour starts, preventing the cycle.</p> <p>In rarer cases, a tape error may also be generated due to a failure in the tape control electromechanical system. In current firmware there are several possible sub-categories for this error which will appear in the digital error log:</p> <ul style="list-style-type: none"> <li>• Tape, Latch – Pinch rollers latched up at cycle start.</li> <li>• Tape, Shuttle – Shuttle photosensor not responding to shuttle move.</li> <li>• Tape, Forward/Backward – Tape supply motor or take-up motor not responding.</li> <li>• Tape, Tension/Un-tension – Tensioner photosensor not responding.</li> <li>• Tape, Capstan – Capstan motor or capstan photosensors not responding.</li> <li>• Tape, Break – Broken or empty tape.</li> </ul> <p>Tape errors caused by failures other than broken tape or latched pinch rollers can usually be identified using the Test &gt; Tape, Test &gt; Membrane, and Test &gt; Nozzle Sensor menus to manually operate the motors and photosensors. See Section 3.4.8, 3.4.11, and 3.4.12. Tape errors can be caused by grit in the shuttle beam slide. Contact tech service if the left/right shuttle slide action is not smooth.</p>

### 6.4.1 Alarm Relay

There is an output relay connection provided on the rear panel of the BAM 1020. This can be connected to an external data logger as a second method of indicating alarms between the BAM and the logger.

This is a Normally-Open (NO) contact; 1 A at 125 VAC or 60 VDC maximum. The normally open (NO) contact pair is open (in a non-conductive state) when it is in a non-alarm state.



## **6.5 Comparison of BAM 1020 Data to Integrated Filter Sampler Data**

Each new BAM 1020 has been calibrated against a reference beta gauge whose calibration is traceable to a gravimetric standard. This calibration information is provided in the calibration certificate that accompanies each BAM 1020 as  $K$  and as  $\mu_{sw}$ . As the BAM 1020 span response is virtually insensitive to the chemical composition of the sampled PM one should expect excellent agreement between mass density determined by a manual filter-based sampler and the mass density determined by a collocated BAM 1020.

Most PM reference methods are based on manual, integrated sampling techniques in which PM is sampled onto pre-weighed filters. Sampled filters are then equilibrated and then re-weighed. The net weight gain is used along with the volume of air sampled to determine the mass density of PM in the sampled volume. PM reference methods may differ from one jurisdiction to another. Furthermore, the BAM 1020 may be operated differently from one jurisdiction to another. For example, the BAM 1020 may be configured to operate as a US-EPA designated PM<sub>2.5</sub> Federal Equivalent Method. Or it may be configured to operate in accordance with EU guidelines for PM<sub>2.5</sub>.

Users may collocate a PM<sub>10</sub> or a PM<sub>2.5</sub> reference sampler with a newly deployed BAM 1020 and collect data on both devices for a period of time in order to demonstrate reasonable correlation and acceptable levels of multiplicative (slope) and additive (intercept) bias between the two methods. Performing such a field test is beneficial as it could reveal an undetected performance or data reporting issue. Common issues could include improper data logger scaling, incorrect background (BKGD) values, or improper flow calibration due to a mis-calibrated flow standard. A scatter plot between the reference standard results (plotted along the x-axis) and the BAM 1020 results (plotted along the y-axis) can reveal these problems.

In order for such an analysis to be useful however it is necessary to have a suitable number of data points, an acceptable level of dispersion (range) in the measured values and acceptable level of correlation ( $r^2$ ) in a regression between the reference results and the BAM 1020 measurements.

Below are several additional considerations:

- Nozzle leaks can lead to poor correlation between the BAM 1020 and the reference standard.
- Improper inlet tube insulation or placing the BAM 1020 directly in the path of an air conditioner vent during operation under hot, humid conditions can lead to poor correlation with the reference standard and unpredictable levels of multiplicative and additive bias.
- The collocated inlets should be at approximately the same height and within several meters of one another during the comparison test.
- The start time and the stop time of the filter-based method should correspond to the hourly BAM 1020 measurement cycles.

## 6.6 Power Up Problems and Electrical Safety Considerations

The BAM 1020 must be at a state where it can be powered on before any other testing or diagnosis can be performed:

- Ensure the external 12V DC power supply (100-240VAC at 50-60Hz) AC power cord is plugged in and the power supply output cable is properly connected to the BAM 1020 power jack on the rear panel.
- Check the fuse (2.0A, 250V SLO BLO) inside internal fuse holder, accessible by removing the BAM 1020 enclosure cover. See Section 2.6.
- If the above checks do not resolve the power-up problem, contact the Met One Instruments service department (see Section 1.2) for further instructions.



*Warning! The BAM 1020 uses hazardous live voltages which can cause electrocution if electrical safety precautions are not strictly followed during service or repair of the machine. The BAM 1020 is designed to provide protection from hazardous voltages during normal operation. If the equipment is modified or used in a manner not specified by the manufacturer, protection provided by the equipment may be impaired.*

Hazardous voltages are present in the following areas:

- **Detector Negative High Voltage DC:** The 82950 circuit board is mounted horizontally inside the BAM 1020 and is covered with a clear plastic safety shield. This circuit board generates a dangerous negative DC bias voltage for the beta detector of between -800 and -1200 volts. Do not remove the clear cover or touch the board without unplugging the BAM 1020. Do not touch the large capacitor when the BAM 1020 is energized.
- **Pump AC:** The vacuum pump is powered by a specific AC line voltage and has its own hardwired power cord. Do not open the electrical junction box on the side of the pump or touch the enclosed solid-state relay without first unplugging the pump power cord.
- **Inlet Heater AC:** The inlet heater is powered by specific AC line voltage. The heater plugs into the heater relay enclosure mounted to the back of the BAM 1020. The heater relay enclosure receives power from a separate AC power cord. See Section 2.5. Do not open the heater relay enclosure cover while the heater relay enclosure is connected to an AC voltage source. Do not remove the cylindrical metal shell from the smart heater module or touch any of the internal parts while the heater is plugged in. The heater module does not contain any serviceable parts inside the metal shell.

## 6.7 Basic Problem and Cause/Solution Table

The following table contains information on some of the more common BAM 1020 problems which may be encountered, and some steps to identify and remedy the problems. Met One welcomes customer suggestions for new items to include in this section of future manual revisions. If the solution cannot be found in the following table, contact one of our expert service technicians for help in resolving the problem. See Section 1.2.

<b>Problem:</b>	<b>The BAM won't start a measurement cycle.</b>
<b>Cause/Solution:</b>	<ul style="list-style-type: none"> <li>• The BAM 1020 is programmed not to start a sample cycle until the beginning of an hour. Make sure the clock is set correctly.</li> <li>• The BAM 1020 will wait until the beginning of a new hour before it starts, even if the Main Operate screen Status is ON.</li> <li>• Don't expect the pump to turn on until the clean tape count is finished, about 8 minutes after the start of the hour.</li> <li>• The BAM 1020 cannot start if the pinch rollers are latched UP! The BAM 1020 cannot lower them.</li> <li>• Make sure the filter tape is installed correctly.</li> <li>• Show the Main Operate screen.</li> <li>• The BAM 1020 will usually display an error if it cannot start a new sample cycle.</li> </ul>

<b>Problem:</b>	<b>The analog output voltage and/or digital concentration reading are full-scale.</b>
<b>Cause/Solution:</b>	<ul style="list-style-type: none"> <li>• The BAM 1020 will force the analog and digital concentration values to full-scale to indicate that an error has prevented the collection of a valid hourly data point, or that the hourly cycle was interrupted. Download the digital error log to identify the cause. The current hourly record after power-up will also be full-scale.</li> </ul>

<b>Problem:</b>	<b>The BAM hourly concentration is reading negative values.</b>
<b>Cause/Solution:</b>	<ul style="list-style-type: none"> <li>• It is possible for the BAM 1020 to occasionally read negative numbers if the actual ambient particulate concentration is below the detection limit of the BAM 1020, such as below 3 micrograms. This is because the BAM has a noise band of several micrograms. This should not happen often.</li> <li>• If the BAM 1020 is reading negative numbers hour after hour, it may be punching holes in the filter tape. These holes can be very small. This is almost always caused by debris on the nozzle or vane. Clean the parts.</li> <li>• The BKGD zero correction offset value may have been incorrectly entered or may need to be audited. Met One supplies the BX-302 zero filter kit for auditing the zero average and noise floor of the BAM 1020. Set the BKGD value to 0.000 during the test.</li> <li>• Look for sources of electrical noise, such as bad grounding. Any source of noise will show up in the zero filter test.</li> <li>• Verify that the inlet tube is grounded to the chassis of the BAM 1020.</li> </ul>

<b>Problem:</b>	<b>The airflow rate is too low and won't adjust up to 16.67 L/min.</b>
<b>Cause/Solution:</b>	<ul style="list-style-type: none"> <li>• The gray plastic pump mufflers on the Medo pumps may clog up after several months. Replace it or drill a hole in the end of it for a temporary fix. The brass mufflers on Gast pumps can often be cleaned.</li> <li>• Some users replace the pump muffler with a 30 inch length of air tubing. This will not clog and reduces the pump noise as well as the mufflers do.</li> <li>• The vacuum pump may need to be rebuilt after about 2 years. Medo pumps slowly loose flow capacity as the pump wears out. Eventually, the flow capacity drops below 16.67 lpm when it needs to be rebuilt.</li> <li>• Checking the 18.4 L/min point during the regular 3-point flow audits verifies the pump capacity.</li> <li>• Check the inlet and PM heads for obstructions.</li> </ul>

<b>Problem:</b>	<b>The airflow is stuck at a particular rate and will not change.</b>
<b>Cause/Solution:</b>	<ul style="list-style-type: none"> <li>• The flow controller unit on some older units can become stuck.</li> <li>• Perform the 3-point flow audit in the Test &gt; Flow Calibration screen. The BAM should try to regulate to these flow values. If the flow does not change, the flow controller may not be working.</li> <li>• Unplug the pump power while performing a 3-point flow check. With the pump off, it should be easy to clearly hear the flow controller pulse at 1-second intervals as it rotates and attempts to regulate the flow. If not, the flow controller is not working, or the circuit board output is not working.</li> <li>• If the flow regulates lower, but not higher than 16.67 lpm, the pump is probably worn out, or there is a leak.</li> </ul>

<b>Problem:</b>	<b>The nozzle gets stuck in the UP position or won't press down onto the tape fully.</b>
<b>Cause/Solution:</b>	<ul style="list-style-type: none"> <li>• With the nozzle in the down position, lift the nozzle up and down with fingertips or thumbs and determine if it feels sticky or gritty.</li> <li>• The nozzle O-ring eventually breaks down and needs to be replaced. See Section 6.8 for instructions.</li> <li>• The brass nozzle bushings may have grit in them. See Section 6.8. Remove the nozzle and clean the parts. A shim kit is required for nozzle reassembly.</li> <li>• A stuck nozzle is sometimes caused by a misaligned inlet tube. Make sure it is straight up and perpendicular to the top of the BAM 1020.</li> </ul>

<b>Problem:</b>	<b>The BAM 1020 has flow leaks, even after cleaning the nozzle and vane.</b>
<b>Cause/Solution:</b>	<ul style="list-style-type: none"> <li>• The nozzle may be sticking as described above. Verify that the nozzle up/down motion is smooth and complete. If the nozzle feels sticky or gritty, it will not seal properly.</li> <li>• Check the O-rings on the sharp-cut cyclone (if used). These can dry out and crack.</li> <li>• Check for bad O-rings on the BAM inlet tube receiver.</li> <li>• Remove the BAM case cover and inspect all air fittings inside the BAM. These are compression fittings and must be fully inserted to prevent leaks.</li> <li>• Inspect the internal and external flow system for split or cracked air tubing.</li> </ul>

<b>Problem:</b>	<b>The BAM 1020 logs frequent "L" Power Failure errors.</b>
<b>Cause/Solution:</b>	<ul style="list-style-type: none"> <li>• The CHASSIS terminal needs to be connected to a good earth ground.</li> <li>• Try plugging the BAM into a computer-style UPS.</li> <li>• Even a split second power failure will cause an "L" error. This will interrupt the sample cycle until the top of the next hour.</li> <li>• Local high power RF fields must be avoided if possible.</li> </ul>

<b>Problem:</b>	<b>Frequent "D" membrane density errors.</b>
<b>Cause/Solution:</b>	<ul style="list-style-type: none"> <li>• This usually indicates the membrane foil surface is dirty or damaged. It can be cleaned with water rinse. Damaged membranes must be replaced.</li> <li>• The membrane assembly may not be fully extending or retracting properly, which causes the metal part of the assembly to partially or completely block the beta particles. Check the membrane motion.</li> <li>• Verify that the Span Membrane (ABS) expected membrane mass matches the calibration certificate.</li> </ul>

<b>Problem:</b>	<b>The clock settings are lost when the BAM 1020 is powered down.</b>
<b>Cause/Solution:</b>	<ul style="list-style-type: none"> <li>• It is normal for the clock to drift as much as 1 minute per month.</li> <li>• The CR 1216 lithium battery on the 30030 circuit board may need to be replaced every 1-2 years.</li> </ul>

<b>Problem:</b>	<b>The filter tape keeps breaking during normal operation.</b>
<b>Cause/Solution:</b>	<ul style="list-style-type: none"> <li>• The photosensors which watch the tape transport motion may be out of alignment. Check the photosensors as described by Section 3.4.8.</li> <li>• This is sometimes caused by misalignment of the “SHUTTLE” photosensor or the interrupter flag on the end of shuttle beam inside the BAM.</li> </ul>

<b>Problem:</b>	<b>The display shows “MISSING AT SENSOR” message.</b>
<b>Cause/Solution:</b>	<ul style="list-style-type: none"> <li>• The BAM 1020 requires a BX-597A or BX-598 sensor to provide ambient temperature data. If no sensor is attached to the Sensor Network RS485 terminals on the rear panel, this message will appear.</li> </ul>

## 6.8 Nozzle Component Service and O-ring Replacement

The BAM 1020 sample nozzle system needs periodic inspection and service to prevent flow leaks. The primary indicator is if the nozzle up/down motion feels sticky or gritty when performing the normal monthly nozzle cleaning, or if the nozzle fails to fully seal against the tape when lowered, causing leakage. The nozzle O-ring may need to be replaced approximately every two years during continuous operation. This is a simple matter and no special tools are required. Instructions for O-ring replacement are below.

The sample nozzle may also be easily removed from the BAM 1020 for further cleaning or rebuild. This requires a set of brass adjustment shims to set the spring tension during reassembly. The standard BX-308 BAM tool kit contains all of the required tools and instructions. The BX-310 kit includes the two shims only.

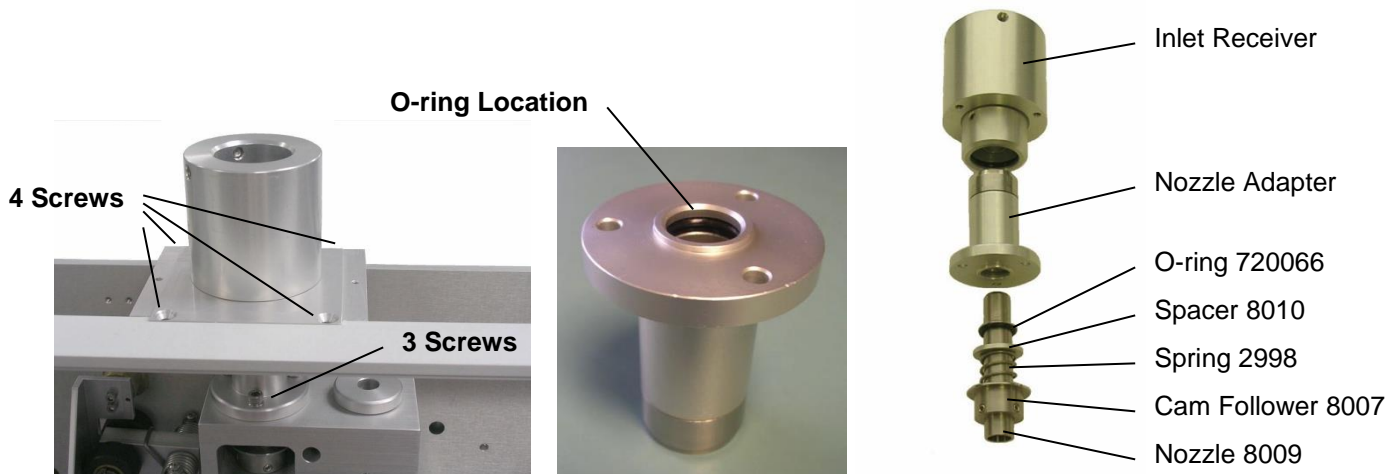
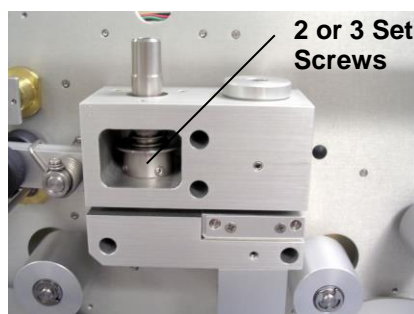

Figure 6-9 BAM 1020 Inlet and Nozzle Components

1. Remove the filter tape and the main BAM 1020 case cover. The sample nozzle must be in the down position. Lower it using the Test > Nozzle Sensors menu, if needed. Lift the nozzle up and down against its spring using thumb pressure and note the action feel.
2. Remove the four screws (two flat head Philips, two 9/64" hex) that fasten the square inlet receiver bracket to the BAM chassis. Lift the assembly off of the BAM. It is not necessary to remove the bracket from the inlet receiver cylinder.
3. Remove the three 9/64" hex screws that fasten the nozzle adapter to the top of the beta block. A T-handle hex wrench is easiest. The nozzle adapter can now be lifted off of the top of the nozzle, revealing the O-ring location. Clean the top of the nozzle.
4. Remove the O-ring from the groove. Thoroughly clean the O-ring groove and the inside of the nozzle adapter using alcohol and cotton-tipped applicators, lubricate the O-ring with silicone grease, then install the new O-ring.
5. Check the nozzle up/down action again before reassembly. If the nozzle action feels smooth, then reinstall the nozzle adapter and inlet receiver assemblies. Check the nozzle action after each step of reassembly to identify any binding or sticking. Perform a normal leak check when finished.
6. **Optional further disassembly (shim set required):** If the nozzle action feels sticky or gritty with the nozzle adapter removed, then the nozzle needs to be removed and the nozzle and bushings cleaned. Loosen the two (or three) set screws in the cam follower (see Figure

6-10) with a 5/64" hex wrench. The nozzle can now be lifted out of the bushings. The cam follower, spring, and spacer can be removed from the front of the block.

7. Clean the nozzle inside and out, and inspect the nozzle face for any burrs or defects. Clean the two brass bushing bores with a cotton-tipped applicator (see Figure 6-10). This is also a good time to clean and inspect the tape support vane since the nozzle is out of the way. The bushings do not need to be lubricated. Reinstall the cam follower, spring, and spacer, and align them with the bushing bores.
8. Lower the nozzle down through the bore. The two brass shims must be positioned as shown in Figure 6-10 before the set screws are tightened to retain the nozzle. The square shim must be under the nozzle face. The slotted shim goes under the cam follower. Tighten the set screws evenly, only a little at a time to avoid distorting or binding the nozzle.
9. Remove the shims and check the up/down action of the nozzle before reassembling the nozzle adapter and inlet receiver. It must feel smooth and even after each step of reassembly. If the nozzle still binds or sticks, then contact technical service.



Nozzle Removal

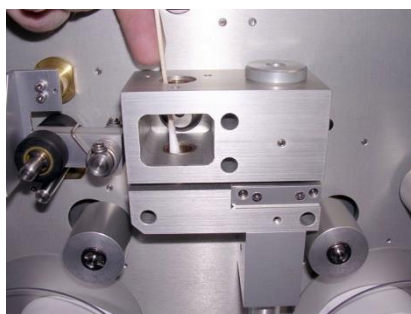

Cleaning the Bushings

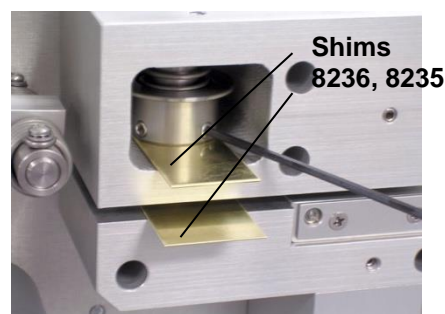

Using Shims for Reassembly

Figure 6-10 BAM 1020 Nozzle Maintenance

## 6.9 Performing the 72-Hour Zero Filter Background Test

All BAM 1020 monitors should have a zero-filter test performed before the equipment is first deployed so that an initial BKGD adjustment may be made, if necessary. This test should be repeated periodically as part of a QA/QC program, the frequency of which is up to the user.

When the BAM 1020 is set up for the first time, a minimum of 48-72 valid 1-hour zero-test data points should be collected in order to accurately determine the Background value. Subsequent, periodic zero tests may be performed with fewer 1-hour values, but this will result in a less accurate Background calculation.

The initial zero-test is used to determine the instrument noise ( $\sigma$ ) and to confirm that the lower limit of detection (LLD), which is  $2\sigma$ , is within specifications. For an 8-minute count cycle the LLD is  $<4.8 \mu\text{g}/\text{m}^3$  for a 1-hour measurement cycle and for a 4-minute count cycle the LLD is  $<7 \mu\text{g}/\text{m}^3$ . The initial zero test and all subsequent zero tests should be performed using an 8-minute count cycle if the BAM 1020 will be operated with an 8-minute count cycle. The zero tests should be performed with a 4-minute count cycle if the BAM 1020 will be operated with a 4-minute count cycle.

The initial zero-filter test should be performed after the BAM 1020 is installed at the monitoring site. If this is not feasible, then performing the test with the monitor sitting on a nearby laboratory bench before deployment is acceptable.

If the BAM 1020 is to be operated with a “smart heater” (BX-826 or BX-827), the zero-filter test should be performed with the smart-heater engaged, but running in “low power mode” for the duration of the test. Low power mode is activated by setting the FRH Set Point to 100% (see Section 3.5.5).

*Weather (rain, mist, very high humidity, high dew point, etc.) can sometimes make it difficult to perform the zero-filter test with the filter mounted outdoors at the monitoring site. In these situations, the BX-302 zero filter assembly should be mounted inside the shelter. Replace the standard inlet tube, with the short 1.5 foot long inlet tube (this tube is included with each BAM 1020 to sample room air). Mount the smart-heater and the BX-302 zero filter assembly on this shorter tube inside the shelter.*

The ambient temperature sensor (BX-597A or BX-598) should always be placed in the same environment from which the air is sampled. If the BX-302 is mounted inside the shelter, the ambient temperature sensor should also be placed inside the shelter.

It is recommended that the BAM 1020 be operated for at least 24-hours before commencing the zero-filter test. A leak check and flow check should be performed before proceeding on to the following steps for the zero-test. Although it is not necessary to reset the existing Background value to 0 for the purpose of conducting the zero-test, doing this will minimize the chance of a miscalculation.

1. Enter the Setup > Calibration menu.
  - a. Record the existing Background value, then change it to 0.0000 (optional).

2. Install the BX-302 zero filter assembly onto the top of the inlet tube.

*Note: When it is necessary, the BX-302 zero filter assembly may be inside the shelter to avoid aspiration of water through the zero filter.*

3. Allow the BAM 1020 to sample for 48-72 consecutive hours, not counting the warm-up period for the initial zero-test. For the zero-test to be valid, no errors should be logged either during the warm-up period or during the 48-72-hour sampling period. For subsequent zero tests the user may decide to use fewer valid data points (such as 24 for example).
4. Calculate the average of the hourly BAM 1020 concentrations to the nearest  $0.1 \mu\text{g}/\text{m}^3$ . **The new Background value is the negative of this average.** For example, if the average of the data sample is  $0.0021 \text{ mg}$  ( $2.1 \mu\text{g}$ ), the correct Background value is  $-0.0021$ . Record the new Background value.

**Note:** If the BAM 1020 is being deployed for the first time, replace the factory-set Background with the new Background value. As Met One Instruments, Inc. runs the initial factory zero-test without the smart heater engaged, the initial zero-test performed by the end user may differ from this value if the end user used a smart heater during the test.

5. Calculate the standard deviation of the sample (STDEV on MS Excel) to the closest  $0.1 \mu\text{g}/\text{m}^3$ . Confirm that the LLD of the BAM 1020 meets the factory specified value.
6. If the results of the zero test indicate that the instrument LLD is higher than the factory specified value or that the Background value has changed by more than  $2 \mu\text{g}/\text{m}^3$  since the most recent field (not factory) zero-filter test, repeat the zero-filter test. If the problem persists, contact the factory.
7. Enter the new Background value into the Setup / Calibration menu on the BAM 1020.
8. Set the FRH Set Point back to the nominal setting to exit low power mode.
9. Resume normal operations or continue with additional testing, as needed.



# 7 DATA COLLECTION AND COMMUNICATIONS

## 7.1 Back Panel Connections

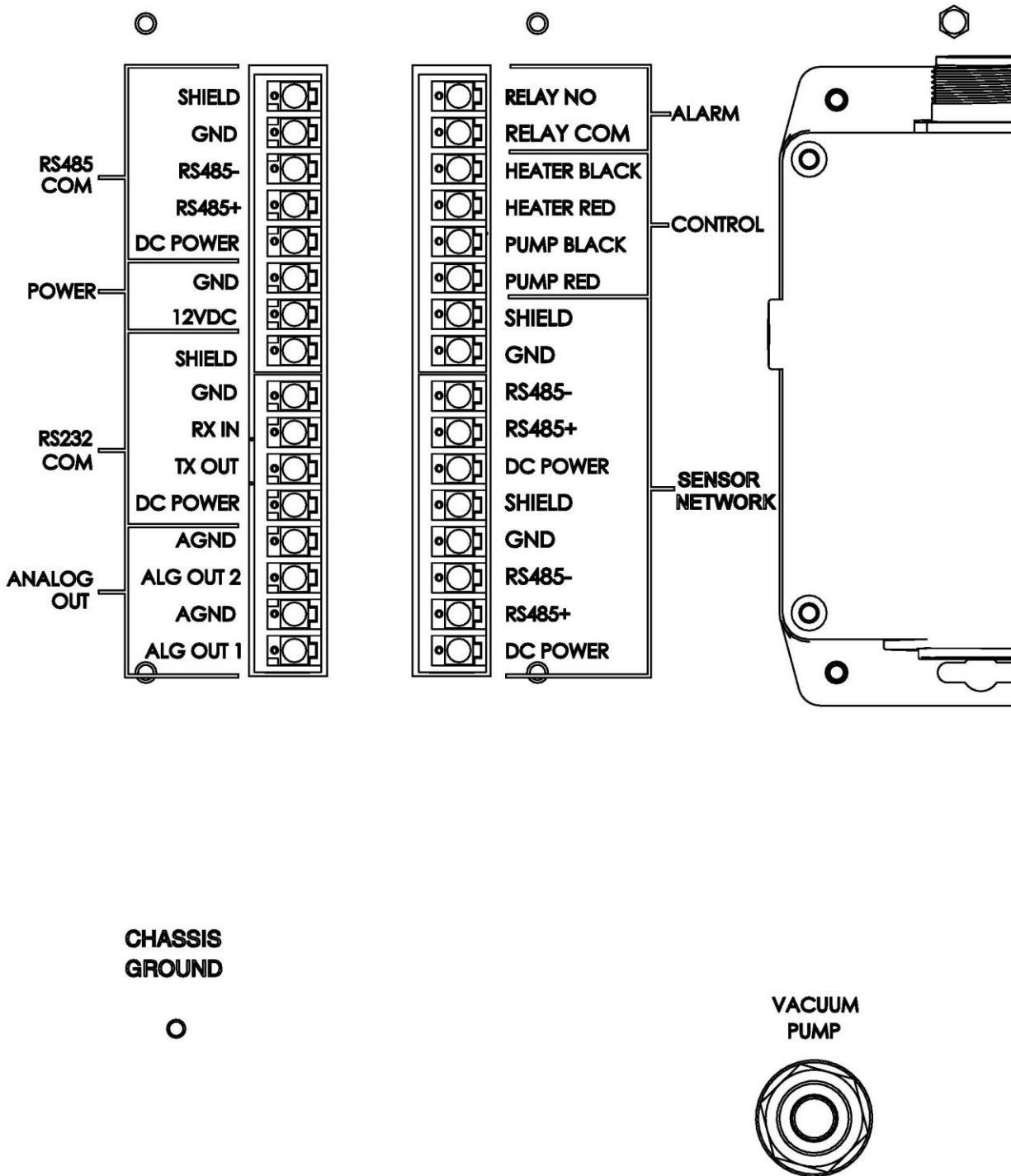

Figure 7-1 Back Panel Connections

1. **RS485 COM:** Terminals provide RS-485 serial communications to the Met One CCS modem or telemetry device.
2. **Power: General +12 VDC power supply output at 500 mA maximum.**
3. **RS232 COM:** Terminals provide RS-232 serial communications to a nearby datalogger or telemetry device.
4. **ANALOG OUTPUT 1 (ALG OUT 1):** BAM concentration (Conc) analog output voltage connection. See Section 7.2.1. Polarity must be observed on this output.
5. **ANALOG OUTPUT 2 (ALG OUT 2):** This is the BAM standard concentration (ConcS) analog output voltage connection. See Section 7.2.1. Polarity must be observed on this output.
6. **ALARM RELAY NO:** Contact-closure output which will be activated (closed) whenever an alarm condition occurs in the BAM (see Section 6.4).
7. **HEATER CONTROL:** Low-voltage output which signals the Smart Heater to turn on or off. Wiring polarity must be observed. The heater control wiring is connected at the factory.
8. **PUMP CONTROL:** Low-voltage output which signals the vacuum pump to turn on or off. There is no polarity on this output because the pump controller has a diode bridge input. Connect the two-wire control cable from the pump to these output terminals.
9. **RS485 SENSOR NETWORK:** RS485 inputs for a BX-597A or BX-598 smart sensor. A second set of inputs allows the addition of another Met One Instruments, Inc. smart sensor, such as the MSO-485 or the AIO 2.

## 7.2 External Data Logger Interface System

This section describes the configuration of the BAM 1020 to work with a separate, external data logger. The BAM 1020 provides an analog concentration output voltage which allows unit to function with many analog data loggers. The BAM 1020 digital data outputs can also be collected with digital data loggers or automatic digital data acquisition systems. In any case, the BAM 1020 internal digital data logging system still stores the complete data array, which can be collected periodically.

This section describes the BAM 1020 configurations required for external data loggers. Consult the data logger documentation for the specific setup requirements for the model being integrated with the BAM 1020. Met One Instruments, Inc. can supply technical bulletins describing sample setup programming for several of the more popular types of data logger.

### 7.2.1 Analog Concentration Output Signal

The BAM 1020 analog output type is configured using the Setup > Analog Outputs menu. See Section 3.5.13 for details.

Analog output voltage 1 (Analog Out 1): BAM Concentration (Conc) at actual conditions

Analog output voltage 2 (Analog Out 2): BAM Concentration (ConcS) at standard conditions

**Important Note:** The scale of the output voltage of the BAM 1020 is determined by the concentration range and offset settings, also configured in the Analog Outputs menu. These are the Conc Range and Conc Offset fields, respectively.

In most applications where the Conc Offset is set to -15, and the Conc Range is set to 1000 ug/m<sup>3</sup>, the BAM 1020 analog output will be scaled as **0.000v to 1.000v equals -0.015 mg to 0.985 mg**. It is critical that the analog data logger input is programmed to scale this voltage correctly, or a significant data offset mistake will occur! The BAM digital data should be periodically compared to the analog

logger data to ensure correct logger scaling. In addition, the BAM output voltage DAC should be tested as described in Section 3.4.16 to ensure that the actual voltage output of the BAM matches the expected voltage.

**Analog Error Encoding:** The analog outputs are the only voltage channels available between the BAM 1020 and the data logger, so any errors generated by the BAM are reported using the same voltage signal. By default, the BAM 1020 will set the analog output to its full-scale reading whenever a critical error prevents a valid concentration from being measured. This behavior can be modified in the Setup Alarms screen (see Section 3.5.10). The digital data values stored in the BAM are always unaffected and available if the alarm was non-critical and did not prevent the hourly concentration measurement from occurring.

### 7.2.2 Early Cycle Mode Option For Analog Data Collection

During a standard BAM 1020 measurement cycle, the BAM 1020 waits for the beginning of the new hour before it sets the analog output to represent the just-finished hour's concentration. However, some types of data loggers must have the concentration value available **before** the new hour starts, or the data will be stored in the wrong hour. The BAM 1020 has a special EARLY cycle mode (Section 3.5.2) which causes the BAM 1020 to start and finish the measurement a few minutes early in order to output the concentration voltage for the last five minutes of the hour which was just sampled. The data logger must be programmed to read this value during the window. Because of the critical timing involved, the BAM 1020 clock will have to be synchronized to the data logger clock using the DT serial command. The following describes the timing of the STANDARD and EARLY modes.

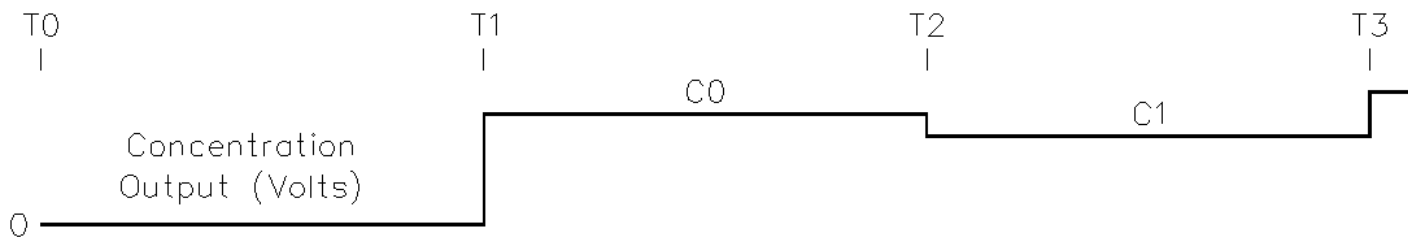

Figure 7-2 STANDARD Cycle Example

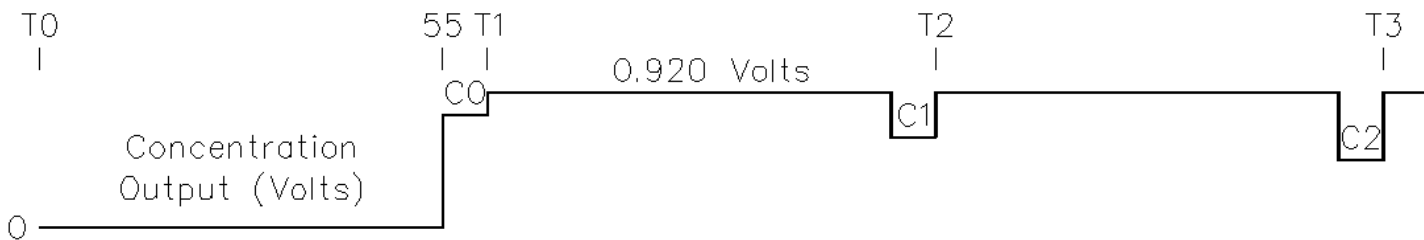

Figure 7-3 EARLY Cycle Example

#### Analog Output Levels

$C_0$  represents the concentration output level measured from time  $T_0$  to  $T_1$ , where the T labels represent the top (beginning) of an hour (such as 12:00:00). The concentration voltage  $C_0$  for the standard cycle is present for the whole next hour following the measurement. In early mode, the  $C_0$  voltage for the current hour is present for only the last 5 minutes of the hour just-sampled (minute 55 to 60), and all other times the concentration output voltage is fixed at 0.920 volts.

### 7.2.3 Interfacing a Digital Data logger with the BAM 1020

Many BAM 1020 users configure an external digital data logger to retrieve data from the BAM 1020. This typically requires some programming experience with the particular type of digital logger to be used. Several environmental data logger manufacturers supply pre-made BAM 1020 drivers for basic data collection applications. All digital files from the BAM 1020 will be obtained through the RS-232, RS-485 or Ethernet port. The BAM 1020 digital files are described in Section 7.3.3.

The most common method is to program the digital logger to request the last hourly comma-separated data record array from the BAM 1020, once per hour, by connecting to one of the ports listed above. Use the <Esc>4 command to return the last record in the data file.

**Clock Timing With Digital Loggers:** Timing must also be considered when collection BAM data with a digital system. If the BAM is operating in standard cycle mode, then the digital concentration data values are updated exactly at the top of the hour. If the digital logger is set to collect the BAM concentration value as soon as it is available, then the clocks should be synchronized to prevent collecting the wrong hourly record.

If the logger must have the BAM concentration before the top of the hour, then the BAM can be set for early cycle mode, and the BAM clock will have to be synchronized to the logger. Some BAM 1020 users leave the BAM in standard cycle mode and set their digital logger to synchronize the BAM clock at minute 59 of the hour. This causes the BAM to be one minute ahead of the logger so that the concentration is available at the top of the logger hour. This method is like running in early cycle mode, except the timing schedule is much easier to understand.

**Warning:** The recommended time to set the clock when the BAM is sampling is between minute 30 and minute 40. Setting the clock outside this range may cause the BAM to sample past the top-of the hour.

## 7.3 Digital Communications and Data Retrieval

This section describes the methods used to retrieve digital data files through one of the serial communications system on the BAM 1020. The BAM 1020 has RS-232, RS-485, USB, and Ethernet ports which may be used with a computer, laptop, modem, or digital data logger. The data can be accessed through the serial ports with a terminal program or by using the free Comet software available from the Met One Instruments website.

### 7.3.1 Direct Serial Port Connections and Settings

The RS-232, RS-485, USB Type B, and Ethernet ports allow for data transfer from the BAM 1020. All data can be accessed from any port.

#### RS-232 Connection:

Most older desktop and laptop computers have a standard 9-Pin serial port available for communications. In these circumstances, the RS-232 terminals can be connected to the serial port using a DB9 to terminal block adapter.

Most newer computers no longer have the 9-Pin serial communications port. In these situations, BAM 1020 monitors may still be connected to the computers by using a USB to serial converter. Of the converters commonly available in local electronics and office supply stores, Met One Instruments, Inc. has seen the most reliable performance from those manufactured by Belkin.

**RS-485 Connection:** This is a 2-wire half duplex system. A common problem is the RS485- and RS485+ connections are missed wired.

#### USB Connection:

BAM 1020 monitors also include a USB Type B port located on the upper right-hand corner of the transport plate.

**Warning:** A Silicon Labs CP210x Driver for this connection must be installed before connecting to this port.

Driver download weblink: <https://www.silabs.com/products/development-tools/software/usb-to-uart-bridge-vcp-drivers>

**Note:** Before using the USB Type B port, ensure an existing RS-232 connection is disconnected.

#### Ethernet Connection:

See Section 3.5.16 and 3.5.17 for details on configuring the IP address for Ethernet communications.

#### Communication Settings:

By default, the RS-232 communicates at 115200 Baud, 8 data bit, no parity, one stop bit, and no flow control. The terminal program baud rate must match the BAM 1020 baud setting.

## 7.3.2 Using Met One Comet Communications Software

Comet is a communications terminal program which can retrieve data from the BAM 1020 using either a direct local connection or a remote connection via various modem types or even an IP address.

The Comet program is very simple and easy to use and can be mastered quickly without having to navigate any of the BAM 1020 terminal menus described in Sections 7.3.3 and 5.

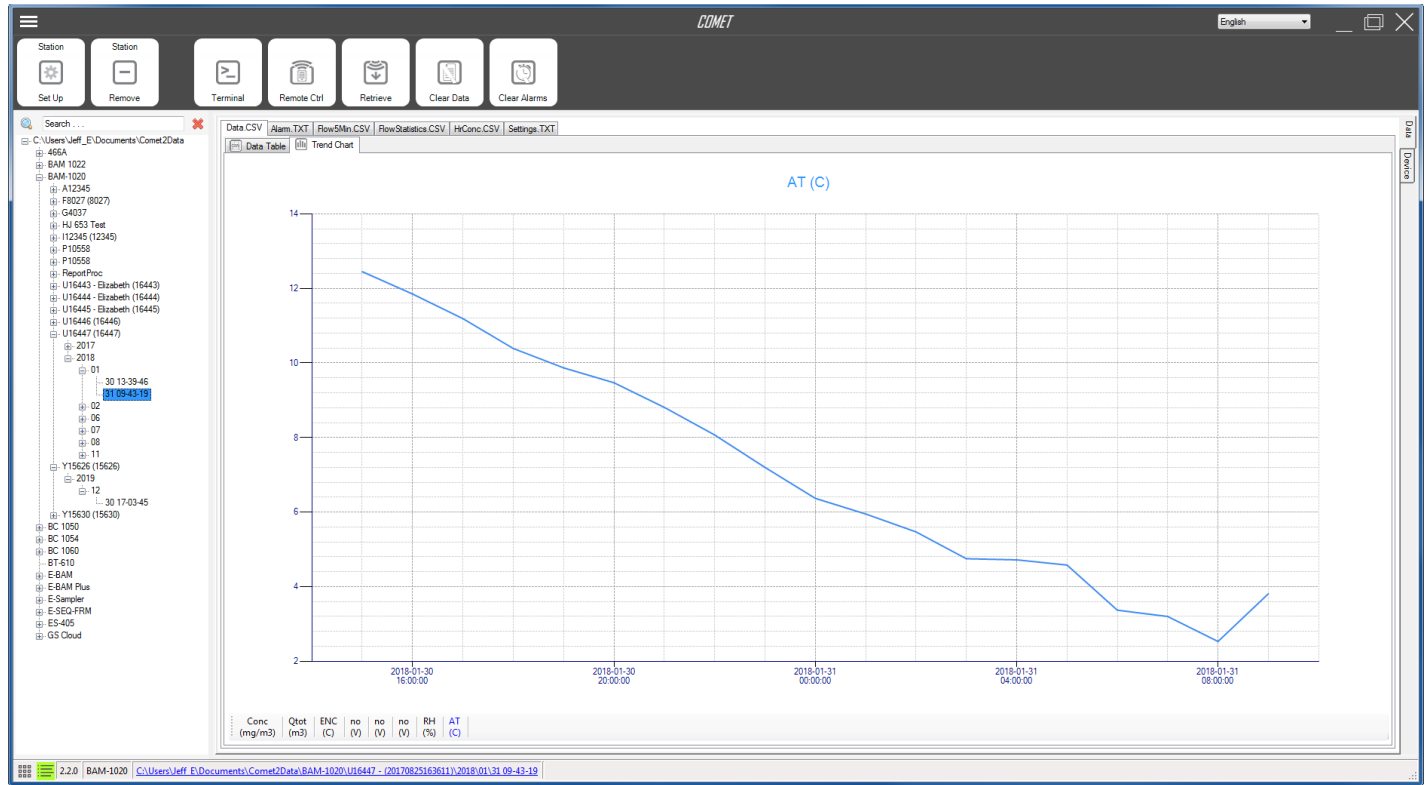

Figure 7-4 Comet Program Interface

**Warning:** A Silicon Labs CP210x Driver for the USB connection must be installed before connecting to the USB Type B port.

The Comet program is available from the Met One Instruments website:

<https://metone.com/products/comet/>

Install the program on the computer, then run it from the Programs directory. Create a new station for the BAM 1020 and then use it to retrieve the data from the BAM 1020 monitor.

The Comet program has a “Terminal” button which provides access to the BAM just as when using any other terminal program as described in Section 5.

### 7.3.3 Downloading Data Using Simple Terminal Programs

The BAM 1020 data can be easily downloaded through the serial ports using HyperTerminal® or other simple terminal programs such as PuTTY. The following describes how to set up a HyperTerminal connection with the BAM 1020:

1. Connect the RS-232 terminals, USB Type B port, or Ethernet port of the BAM to the computer or laptop using the appropriate cable.  
**Note:** Before using the USB Type B port, ensure an existing RS-232 connection is disconnected.
2. Open HyperTerminal and it will request a name for the connection. Type “BAM 1020” or any other name that makes sense for the application and then click “OK”.
3. The “Connect To” window will open. Select COM1 (or another port, if used) from the drop-down menu in the “Connect Using” field. Click “OK”. Note: HyperTerminal can also be set up to dial the BAM 1020 through a modem in this window.

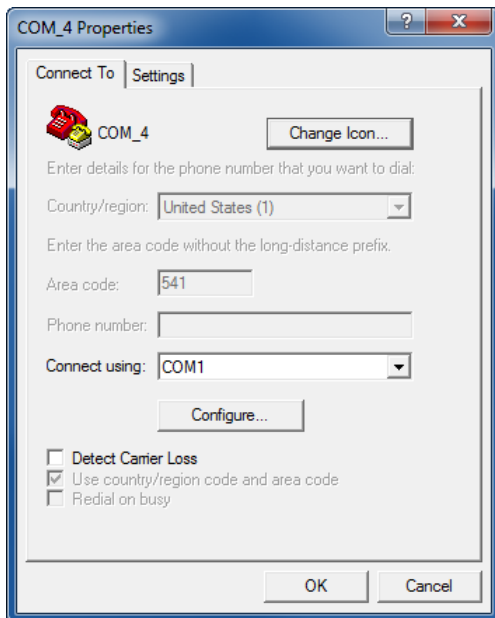

4. The “COM1 Properties” window will open. Set the following values in the drop-down menus, then click “OK”.

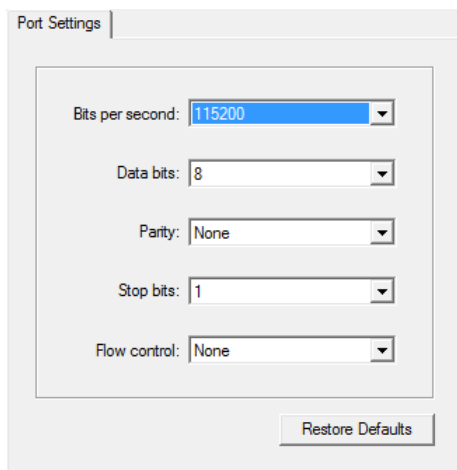

5. The main HyperTerminal connection window should now be open. Rapidly press the **Enter** key three times. The window should respond with an asterisk (\*) indicating that the program has established communication with the BAM 1020.
6. Once communication is established, press the **h** key followed by the **Enter** key. This should cause the BAM 1020 System Menu to appear on the window as shown in Figure 7-5. Sending any of the ASCII characters shown in the menu will perform the described action, such as retrieve the data files. The menu options are described in Section 5.
7. HyperTerminal will only display 100 lines of data in the window. To capture larger files (such as All Data), first select Transfer > Capture Text from the drop-down menu. Select a location for the file, then click the "Start" button. Retrieve the desired files, and HyperTerminal will automatically store them to the text file. Anything that comes through the terminal window will be saved to the file. Click the "Stop" button to stop capturing the text and save the file.
8. When exiting HyperTerminal, it will ask to save the connection. Click "Yes" and a file named BAM 1020.ht (or whatever name was given when creating the connection) will be created in the HyperTerminal folder, which will have all of the settings saved. Use this for future communications with the BAM 1020.

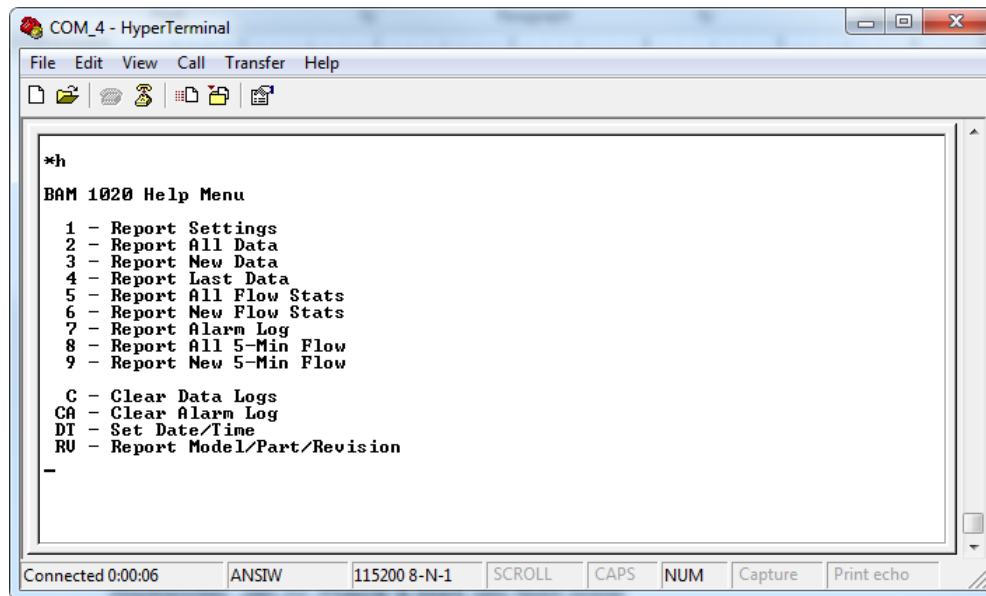

Figure 7-5 Terminal Window Showing the BAM 1020 Menu

### 7.3.4 Help Menu and Command Descriptions Using a Terminal Program

Once a serial connection between a terminal program and the BAM 1020 has been established as shown in Figure 7-5, access is available to the BAM 1020 Help Menu. The common commands are listed. Enter the command characters followed by the **Enter** key. The command descriptions follow.

**Note:** After a 5-minutes with no key presses, the BAM 1020 will cancel communications and the **Enter** key will need to be quickly pressed three times to reestablish the connection. Once the asterisk command prompt is displayed, press "h" to access the menu again or enter the desired command if it is already known.

**Note:** There are many more commands not listed in the Help Menu. Refer to the BAM 1020 User 7500 document for a complete list with expanded description. It is located on the Met One web site.



## Command 1 – Settings Report

This report shows the BAM 1020 settings and calibration values. This is useful for verifying the setup parameters and will most likely be requested by the factory if service is required. This report is subject to change with firmware updates.

BAM 1020 Settings Report  
2020-06-08 17:07:33

Station ID, 9  
Serial Number, A14540

Firmware, 83347, R9.0.0  
Display, 82451, R1.1  
Digital 1, 597, 10503-01, R01.0.0

K, 1.000  
Background, 0.0000  
Usw, 0.302  
Span Membrane, 0.851  
Conc Units, ug/m3  
Beta Count, 8-MINUTE  
Conc Error, FULL SCALE VALUE  
Inlet Type, PM2.5  
Span Check, 1 HR  
Factory Mode, OFF

Standard Temp, 25 C  
Tape Pressure, 150  
Pres Units, mmHg

FRH Set Point, 35  
Low Power, 20

BAM Sample, 42  
MET Average, 1 HR  
Cycle Mode, STANDARD  
Maintenance, OFF

Time Stamp, ENDING  
Interval Output, 0

Conc Range, 1000 ug/m3  
Conc Offset, -15 ug/m3  
Analog Range 1, 0-2.5 V  
Analog Range 2, 0-2.5 V  
DAC Cal 1, 0.0,0,2.5,29789  
DAC Cal 2, 0.0,0,2.5,29789

RS-232, 9600  
Flow Control-232, NONE  
RS-485, 115200

Modbus Port, RS-232  
Modbus Address, 1  
Byte Order, 512

IP Config, Static, DHCP  
IP Address, 0.0.0.0, 0.0.0.0:7500  
Subnet Mask, 0.0.0.0, 0.0.0.0  
Gateway, 0.0.0.0, 0.0.0.0

Report Type, CHINA HJ 653  
Conc Type, ACTUAL  
Conc Range, 1000 ug/m3  
Conc Offset, -15 ug/m3

```

Dynamic Range, EXTENDED
  BP Log, CHAN 1
  Memb Log, CHAN 2
  RH Log, CHAN 3
  FRH Log, CHAN 4
  FT Log, CHAN 5

Flow Zero, 0.03

Name, Offset, Slope
Flow, 0.000, 1.000
  AT, 0.000
  BP, 69.269
  FT, 0.000
  FRH, 0.000
  FP, -30.754

Sound Volume, 10
Language, English

```

### Command 2, 3, and 4 – All, New, Last Data Report

These commands report the user Data file in a CSV type format (See section 3.5.9.1).

The 2-command will report the entire file.

The 3-command will report starting from the last record reported.

The 4-command reports the last record in the file.

Use the `PR 1 ts` command to start a report from the given `ts`.

<code>ts</code>	Timestamp Description
	No parameter prints all the data
<code>-1</code>	Print the new data
<code>1 to 2000</code>	Print from the previous <code>n</code> -hours
<code>YYYY-MM-dd HH:mm:ss</code> <code>YYYY-MM-dd HH:mm</code> <code>YYYY-MM-dd HH</code> <code>YYYY-MM-dd</code> <code>YYYY-MM</code> <code>YYYY</code>	Print from the timestamp value

Response
<code>Time, Conc (ug/m3), ConcS (ug/m3), Qtot (m3), QtotS (m3), Flow (lpm), WS (m/s), WD (Deg), AT (C), RH (%),</code> <code>BP (mmHg), FT (C), FRH (%), Memb (mg/cm2), Status</code> <code>2020-06-05 18:00:00,+00003.0,+00003.0,0.698,0.698,+16.65,00.0,000,+024.4,032,792.7,+026.2,024,</code> <code>0.856,00000</code>

## Command 5 and 6 – All and New Flow Stats

These commands report the Flow Stats file in a CSV type format.

The 5-command will report the entire file.

The 6-command will report starting from the last record reported.

Use the `PR 4 ts` command to start a report from the given `ts`.

### Response

```
Time,Elapsed(HH:mm:ss),Flow(lpm),CV(%),Vol(m3),Flag,AT(C),AT Min,AT Max,BP(mmHg),BP Min,BP Max
2020-06-05 17:08:36,00:41:58,16.66,0.2,0.698,0,24.4,24.3,24.7,792.7,792.6,792.8
2020-06-05 18:08:27,00:41:58,16.66,0.1,0.698,0,24.4,24.3,24.6,792.8,792.7,792.9
```

## Command 7 – Alarm Log

This command reports the Alarm file in a CSV type format.

### Response

```
Alarm Report
2020-06-08 17:07:33
Station, 9, A14540

Time,Alarm
2020-06-05 16:42:01, Maintenance
2020-06-05 16:46:33, Power Fail,POWER CYCLE
```

## Command 8 and 9 – All and New 5-Min Flow

These commands report the 5-Min Flow file in a CSV type format.

The 8-command will report the entire file.

The 9-command will report starting from the last record reported.

Use the `PR 5 ts` command to start a report from the given `ts`.

### Response

```
5-Minute Flow Report
2020-06-08 17:07:34
Station, 9, A14540

Time,Flow(lpm),AT(C),BP(mmHg),FP(mmHg)
2020-06-05 17:13:39,16.70,24.4,792.7,501.6
2020-06-05 17:18:39,16.68,24.4,792.7,501.8
```

### Command C – Clear Data Logs

This command clears the User, Flow Stats, and 5-Min Flow data logs.

### Command CA – Clear Alarm Log

This command clears the Alarm logs

### Command DT – Get/Set Date/Time

This command gets or set the Date and Time.

Command	Description
DT	Get the date and time part of the real time clock.
DT yyyyMMddHHmmss DT yyyy-MM-dd HH:mm:ss	Set the date and time part of the real time clock.

Parameter	Description
yyyy	Years 2000 – 2037
MM	Months 1 – 12
dd	Days 1 – 31
HH	Hours 0 – 23
mm	Minutes 0 – 59
ss	Seconds 0 – 59

### Command RV – Report Firmware Revision

This command will report the model number, firmware part number, and revision string. Instruments with more than one processor or programmable devices will include more than one part number and revision on the next subsequent lines.

Response
BAM 1020, 83347, R9.0.0 Display, 82451, R1.1

### 7.3.5 Modem Option

The Met One Instrument BX-911 modem is recommended for use with the BAM 1020.

Follow the instructions provided with the BX-911 modem.

### 7.3.6 BAM 1020 Firmware Upgrade

The BAM 1020 CPU board (30030) runs the main instrument control firmware program.

**Warning:** Before upgrading the firmware, save all the data log and setting files to a USB flash drive. (Operate > Transfer Data > Days ALL DAYS, Files ALL > COPY).

The Firmware Upgrade Installer will be sent to you by e-mail.

Run the Firmware Upgrade Installer on the Personal Computer (PC) to use for the upgrade.

The PC must have a USB Type A port.

**Warning:** Do not plug the device into the USB port until the correct USB Driver is installed on the PC. It can also be found at this Weblink: <https://www.silabs.com/products/development-tools/software/usb-to-uart-bridge-vcp-drivers>.

The BAM 1020 RS-232 port baud rate must be set to 115200 (Setup > Serial Ports > RS-232 Baud).

The BAM 1020 Flow Control-232 must be set to NONE (Setup > Serial Ports > Flow Control-232).

**Warning:** Disconnect any connections to the RS-232 terminals.

Locate a Type A to Type B USB cable.

Connect USB Type A to the PC.

Connect USB Type B to the BAM 1020 RS-232 USB Type B port.

The firmware can only be updated through the RS-232 USB port (Type B)

From the Start menu go to Program Files (x86)\Met One\BAM 1020 Firmware Installer and run the BAM 1020 Firmware Installer.

The program will list the available COM ports and prompt you for the COM port number. If the USB driver is loaded correctly, the port should show up as "CP201x USB to UART Bridge" Enter the number and press the Enter key to begin the upgrade process.

```
ARM Firmware Update Utility, v R1.1.0.1a
Available COM Ports
COM1 <Communications Port>
COM3 <MOXA Port 0>
COM4 <MOXA Port 1>
COM7 <Silicon Labs CP210x USB to UART Bridge>
Select COM Port: COM
```

A 'Programming complete!' message will be displayed at the end of the upgrade process.







Execution time is approximately 2-minutes.



After the firmware upgrade it is always good practice to verify all the settings and sensor calibrations.

## 8 ACCESSORIES and PARTS



### 8.1 Consumables, Replacement Parts, and Accessories

The following parts are available from Met One for maintenance, replacement, service, and upgrades. If unsure which part is needed, please contact the Service department and provide the serial number of the BAM 1020. Some of these parts require technical skills or special considerations before use or installation.





<b>Consumables</b>		
<b>Description</b>	<b>Part Number</b>	<b>Graphic</b>
Filter Tape Roll, Glass Fiber, 70+ days per roll 30mm x 25m	<b>460180</b>	
Cotton-Tipped Applicators, nozzle cleaning, 100 pack Solon #362	<b>995217</b>	
Silicone O-Ring Grease, mini packets	<b>995712</b>	
<b>Calibration &amp; Service Tools</b>		
<b>Description</b>	<b>Part Number</b>	<b>Graphic</b>
BAM 1020 Basic Service Tool Kit: Includes nozzle shims, reel spacer, filter sensor removal tool, dark test shim, rubber leak check tool, hex wrenches.	<b>BX-308</b>	
BAM 1020 Distributor Service Tool Kit: Includes all of the above plus two spring scales.	<b>BX-308-1</b>	
BAM Inlet Cleaning Kit Includes pull-rope, tube brush, microfiber rags, cleaning brushes, O-ring grease, cotton applicators. For cleaning inlet tube and PM10, PM2.5 inlets.	<b>BX-344</b>	
Nozzle Adjustment Shim Kit. 8235/8236 Shims Only.	<b>BX-310</b>	
Rubber Leak Test Nozzle Seal Tool	<b>7440</b>	
Span Membrane Assembly, Standard Replacement Approx. 0.800 mg/cm2	<b>8069</b>	
Span Membrane Assembly, Mid-Range Approx. 0.500 mg/cm2	<b>BX-301</b>	
Flow Inlet Adapter Kit (Leak Test Valve) Includes short inlet tube adapter.	<b>BX-305</b>	

Zero Filter Calibration Kit, with leak check valve. Required for PM2.5 FEM monitoring. Same as BX-305 but with 0.2 micron filter.	<b>BX-302</b>	
Volumetric Flow Calibration Kit (BGI deltaCal™) Flow, Temp, and Pressure Reference Standards Met One recommended flow meter	<b>BX-307</b>	

### Vacuum Pumps & Pump Parts







Description	Part Number	Graphic
Pump, Medo, 115 VAC, 50/60 Hz, Low Noise	<b>BX-126</b>	
Pump, Gast, Rotary Vane, 100/115 VAC, 50/60 Hz	<b>BX-121</b>	
Pump, Gast, Rotary Vane, 220/240 VAC, 50/60 Hz	<b>BX-122</b>	
Muffler, Medo/Gast Pump, Replacement	<b>580293</b>	
Gast Pump Rebuild Kit. Vanes, filters.	<b>680828</b>	
Medo Pump Rebuild Kit, Piston, filters	<b>680839</b>	
Pump Service Kit, Filter Replacement, Medo	<b>8588</b>	
Pump Controller (Relay Module Only) Medo	<b>BX-139</b>	
Pump Controller (Relay Module Only) Gast	<b>BX-139-1</b>	



### Flow System Components

Description	Part Number	Graphic
Flow Sensor, Mass, 0-20 LPM, Internal Assembly	<b>80324</b>	
Automatic Flow Controller	<b>8776</b>	
Filter Assembly, Pisco In-line	<b>580291</b>	
Filter Element Only, Pisco In-line	<b>580292</b>	
Filter RH Sensor Replacement Only	<b>9278</b>	
Filter Temperature Sensor Replacement Only	<b>81493</b>	

O-Ring, Nozzle	<b>720066</b>	
Nozzle Rebuild Kit, with parts and tools	<b>80355</b>	
O-Ring, Inlet Tube Receiver, 2 required.	<b>720069</b>	
O-Ring Kit, Inlet Tube Receiver and Nozzle.	<b>9122</b>	
Pump Tubing, Clear, 10mm O.D., 6.5mm I.D. Polyurethane, 25 foot roll standard	<b>960025</b>	
<b>Electrical &amp; Electronic Parts</b>		
<b>Description</b>	<b>Part Number</b>	<b>Graphic</b>
External Power Supply	<b>510634</b>	<b>Contact Technical Service for Circuit Board Replacement Information.</b>
Circuit Board, CPU Core	<b>30030</b>	
Circuit Board, Transport I/O	<b>82950</b>	
Circuit Board, Personality	<b>82940</b>	
Circuit Board, Wiring Panel	<b>82970</b>	
Touch Screen Door Assembly	<b>83023</b>	
Rear Panel Assembly	<b>83387</b>	
Fuse, 2.0 A, Slo-Blo, 5x20mm. 1 per unit.	<b>590819</b>	
Gear Motor Assembly, 4 RPM. 4 per unit.	<b>83358</b>	
Gear Motor Assembly, 10 RPM, Capstan Drive Only.	<b>83359</b>	
<b>Inlet Components</b>		
<b>Description</b>	<b>Part Number</b>	<b>Graphic</b>
PM10 Size-Selective Inlet Head, EPA Specified	<b>BX-802</b>	
TSP Sampling Inlet, with insect screen	<b>BX-803</b>	
PM2.5 WINS Impactor	<b>BX-804</b>	
PM2.5 Sharp Cut Cyclone	<b>BX-807</b>	
PM2.5 Very Sharp Cut Cyclone, BGI Inc. VSCC™ Valid for PM2.5 FEM monitoring	<b>BX-808</b>	
PM2.5 Cyclone – URG Valid for PM2.5 FEM monitoring	<b>BX-809</b>	
Inlet Roof Mounting Kit – includes roof top flange, sealing gland, braces, and standard 8 foot inlet tube.	<b>BX-801</b>	
Waterproof Inlet Tube Sealing Gland Only	<b>8119</b>	
Roof Top Flange Weldment Only	<b>8120</b>	



Inlet Tube Coupler Assembly, with O-rings Connects two inlet tubes together Inlet tube sold separately	<b>BX-821</b>	
Inlet Tube Extension Kit, 4 foot, with coupler and tube	<b>BX-822</b>	
Inlet Tube Extension Kit, 8 foot, with coupler and tube	<b>BX-823</b>	
Inlet Tube, Aluminum, 8 foot length standard	<b>8112</b>	
Inlet Tube, Custom Length Dash number is length in feet, 8' max per tube	<b>8112-X</b>	
Smart Heater Element with Cable, 115 VAC	<b>81120</b>	
Smart Heater Element with Cable, 230 VAC	<b>81121</b>	
Smart Heater Insulating Sleeve, White	<b>9123-1</b>	
O-Rings, BX-807 SCC Cyclone, set of 6	<b>720097</b>	
O-Rings, BX-808 VSCC™ Cyclone, set of 8	<b>720105</b>	
O-Rings, BX-809 URG Cyclone, set of 6	<b>720228</b>	
O-Rings, PM10 Head, set of 3	<b>8965</b>	
<b>Meteorological Sensors</b>		
<b>Description</b>	<b>Part Number</b>	<b>Graphic</b>
BX-597A AT/BP/RH Sensor (Without digital cable assembly)	<b>BX-597A</b>	
BX-598 AT Sensor (Without digital cable assembly)	<b>BX-598</b>	
Cable assembly for BX-597A/BX-598 sensor, 25 Feet	<b>82929-25</b>	
All In One Weather Sensor	<b>AIO 2</b>	
Cable assembly for AIO 2 sensor (specify length)	<b>10624</b>	
Met Station One	<b>MSO-485</b>	

<b>Communications Options &amp; Accessories</b>		
<b>Description</b>	<b>Part Number</b>	<b>Graphic</b>
Cellular/IP Modem Kit for BAM 1020	<b>BX-911</b>	
COMET Cloud Service Modem (For use outside USA)	<b>CCS Modem 2</b>	
CCS Modem-LTE (For use in USA)	<b>CCS Modem-LTE</b>	
CCS Modem Communication Cable, 25 Feet	<b>83444-25</b>	
<b>Weatherproof Mini Shelters/Enclosures</b>		
<b>Description</b>	<b>Part Number</b>	<b>Graphic</b>
Mini Enclosure, Heated and Vented. Mfg by Shelter One	<b>BX-902B</b>	
Mini Enclosure, Heated and Air Conditioned. Mfg by Ekto. 2000 BTU A/C.	<b>BX-903</b>	
Mini Enclosure, Heated and Air Conditioned. Mfg by Ekto. 4000 BTU A/C.	<b>BX-904</b>	
Enclosure, Dual Unit, Heated and Air Conditioned. Mfg by Ekto. 4000 BTU A/C.	<b>BX-906</b>	

## 9 THEORY OF OPERATION

$^{14}\text{C}$  (carbon-14) is a naturally occurring isotope of carbon that forms in the atmosphere by the interaction of cosmic rays with nitrogen. Of the three naturally occurring isotopes of carbon,  $^{14}\text{C}$  is the only to occur in trace amounts. The half-life of  $^{14}\text{C}$  is 5,730 years. It undergoes beta-decay and is converted into  $^{14}\text{N}$  (nitrogen-14). During the beta decay process high energy electrons are emitted. Beta radiation through the decay of  $^{14}\text{C}$  is distributed around an average energy of approximately 49 keV. In air these electrons travel a maximum distance of around 22 cm before being fully absorbed.

Beta-ray absorption is the principle by which the BAM 1020 makes its measurement.  $^{14}\text{C}$  is convenient source to use in beta absorption measurements. Its long half-life means that the source will outlast the service life of the instrument. When used in modest amounts (less than 100 microcuries), generally no license is required to possess the equipment.

This beta ray absorption process by matter may be described by the following relationship:

$$I = I_0 \exp\left(-\frac{\mu M}{S}\right)$$

In the above equation  $I_0$  is the measured beta ray flux (counts) across clean filter tape,  $I$  is the measured flux (counts) across aerosol-laden filter tape,  $M$  is the aerosol mass deposited on the filter tape (mg),  $S$  is the spot area ( $\text{cm}^2$ ).  $\mu$  is the beta ray absorption cross section ( $\text{cm}^2/\text{mg}$ ). The absorption cross section  $\mu$  to a very good approximation depends only on the mass of the absorbing species and not on its chemical composition. In other words the absorption cross sections for commonly found species in ambient particulate matter such as soot, iron oxide, silica, or salt are all approximately the same. It is for this reason that one does not need to know ahead of time the chemical composition of the aerosol being sampled in order to perform an accurate mass measurement using the BAM 1020.

During the factory calibration process, the BAM 1020 being calibrated is first challenged with a membrane whose mass density  $\left(\frac{M}{S}\right)$  is known. Repeated measurements of  $I_0$  and  $I$  for the beta gauge under calibration allows us to calculate the absorption cross section  $\mu$  as is shown below:

$$\mu = \frac{S}{M} \ln\left(\frac{I_0}{I}\right)$$

Tiny variations in the measured absorption cross section  $\mu$  will be found from one BAM 1020 to the next. These differences are due to small differences between the activities of the beta sources and due to small differences in the geometries (i.e., manufacturing tolerances) that exist between one instrument and the next. This membrane calibration process allows us to standardize the span response of all BAM 1020 monitors.

The same membrane whose known mass density  $\left(\frac{M}{S}\right)$  is used to determine  $\mu$  is built into the instrument and subsequently used to challenge the same BAM 1020 on an hourly basis to ensure that the original span calibration is being held.

A final calibration is then performed on this BAM 1020. It is collocated with a reference BAM 1020 monitor. The collocated monitors then sample and measure the same aerosol (smoke) for 24 hours. A linear regression of the hourly output of the BAM 1020 under test against the transfer standard BAM 1020 will provide a slope “ $k$ ” is used to set the final calibration. This is shown in the equation below.

$$C = k \frac{m}{V} + BKGD$$

In this equation  $C$  is the aerosol mass concentration in  $\text{mg}/\text{m}^3$ ,  $m$  is the sampled mass in  $\text{mg}$ ,  $V$  is the sampled volume in  $\text{m}^3$ , and  $BKGD$  is the instrument response in the absence of any particulate matter as determined by the zero-filter test in  $\text{mg}/\text{m}^3$ .

The span membrane response is in  $\text{mg}/\text{m}^3$  and depends only on  $\mu$ , the beta ray absorption cross section, whereas  $C$ , the measured aerosol concentration in  $\text{mg}/\text{m}^3$  depends on both  $\mu$ ,  $k$ , and  $BKGD$ . Since sampled volume is also used in this calculation the accurate determination of  $C$  also depends on the ability of the equipment to accurately measure volume.