

ES-405

PARTICULATE PROFILER

OPERATION MANUAL

REVISION C



Met One Instruments, Inc.

1600 NW Washington Blvd.

Grants Pass, Oregon 97526

Telephone 541-471-7111

Facsimile 541-471-7116

ES-405 Particulate Profiler Operation Manual - © Copyright 2020 Met One Instruments, Inc. All rights reserved worldwide. No part of this publication may be reproduced, transmitted, transcribed, stored in a retrieval system, or translated into any other language in any form without the written permission of Met One Instruments, Inc.

Table of Contents

1	INTRODUCTION.....	5
1.1	About This Manual.....	5
1.2	Technical Service and Warranty	5
1.3	About the ES-405	6
1.4	Laser Radiation Safety and Conformity.....	6
1.5	ES-405 Specifications.....	7
2	ES-405 SETUP and STARTUP	8
2.1	Standard and Optional Accessories	8
2.2	Mounting Options.....	8
2.3	Setting Up the ES-405	9
2.4	Electrical Connections	12
2.5	Power-Up and Starting Operation	12
2.6	Default Setup.....	13
3	SITE SELECTION and REMOTE POWER OPTIONS.....	14
3.1	Site Selection Requirements.....	14
3.2	Fall Hazard and Security Cautions	15
3.3	Confined Sampling Locations	15
4	ES-405 USER INTERFACE and MENU SYSTEM	16
4.1	The User Interface - Keypad and Display Functions.....	16
4.2	Using the Main Sampling Screen.....	17
4.3	Using the Main ES-405 Menu System and Clearing Memory	18
5	ES-405 MEASUREMENT METHOD	19
5.1	Sheath Air	19
5.2	Detection.....	19
5.3	Sizing and Counting	19
5.4	Calibration.....	19
5.5	K-Factor	19
5.6	Sample RH Control for Light Scatter Mass.....	20
6	SETUP MENU DESCRIPTIONS	21
6.1	SAMPLE Setup	21
6.2	CLOCK Setup.....	22
6.3	SERIAL PORT	22
6.4	MEMORY.....	22
6.5	ALARM OUTPUT.....	23

7	CALIBRATE MENU – FIELD CALIBRATIONS	24
7.1	CALIBRATE Menu.....	24
7.1.1	CALIBRATE Flow Screen	24
7.1.2	CALIBRATE FP Screen.....	25
7.1.3	K-FACTOR Screen.....	25
8	MAINTENANCE and TROUBLESHOOTING	26
8.1	Basic Problem and Cause/Solution Table	26
8.2	Suggested Periodic Maintenance Intervals	27
8.3	AQ Flow Calibration	27
8.4	Filter Change.....	27
8.5	TSP Inlet Cleaning.....	27
8.6	Factory Service Interval.....	28
9	DATA RETRIEVAL and COMMUNICATIONS.....	29
9.1	Serial Port Connections to a Computer.....	29
9.2	Modem Options for Remote Data Retrieval.....	29
9.3	Comet™ Data Retrieval Software	29
9.4	Downloading Data Using a Terminal Emulator	30
9.5	Data Retrieval Commands Through the Serial Port	30
9.5.1	User Communication	30
9.5.2	Computer Communication	31
9.5.3	Computer Command Format.....	31
9.5.4	Checksum Computation	31
9.5.5	Serial Command List.....	31
9.6.3	SK Command.....	33
10	PARTS and ACCESSORIES.....	34
10.1	Consumables, Replacement Parts, and Accessories	34
10.2	Combination Sensor Options	35
10.2.1	EX2-034	35
10.2.2	EX2-AIO.....	35
10.2.3	597A	36
10.3	CCS Modem.....	36

1 INTRODUCTION

1.1 About This Manual

This document is organized with the most important information grouped together for easy reference by the user. All ES-405 owners and operators should read and understand the sections on installation, setup, and field calibrations. Other sections that provide in-depth information on subjects such as theory, diagnostics, accessories, and alternate settings provide valuable information which should be consulted as needed. An electronic version of this manual is also available.

1.2 Technical Service and Warranty

This manual is structured by customer feedback to provide the required information for setup, operation, testing, maintaining, and troubleshooting your ES-405 unit. Should you still require support after consulting your printed documentation, we encourage you to contact one of our expert Technical Service representatives during normal business hours of 7:00 a.m. to 4:00 p.m. Pacific Time, Monday through Friday. In addition, technical information and service bulletins are often posted on our website. Please contact us and obtain a Return Authorization (RA) number before sending any equipment back to the factory. This allows us to track and schedule service work and to expedite customer service.

Phone: **(541) 471-7111**

Fax: (541) 471-7116

E-Mail: service@metone.com

Web: www.metone.com

Address: Technical Services Department
Met One Instruments, Inc.
1600 NW Washington Blvd.
Grants Pass, OR 97526

1.3 About the ES-405

The Met One Instruments, Inc. model *ES-405 Particulate Profiler* is a near reference air quality sensor which automatically measures and records real-time airborne PM_{1.0}, PM_{2.5}, PM_{4.0}, and PM₁₀ particulate concentration levels using the principle of right angle laser light scatter. Detailed descriptions of the ES-405 measurement modes can be found in Section 5.

Laser Light Scatter System

Sample air is drawn into the ES-405 detector chamber and subjected to an intense laser beam located at right angles to the flow. Particles pass through the laser beam and scatter light that is collected onto a photodiode detector. The output of the detector is analyzed to determine the number and size of the particles and mathematically processed to provide an indicative particulate mass measurement.



1.4 Laser Radiation Safety and Conformity

The ES-405, when properly installed and operated, is considered a Class I laser product. Class I products are not considered to be hazardous.

This system contains a diode laser operating at 100 mW power and 785 nm wavelength. This is not visible to the naked eye and can cause damage to the eye if directly exposed. A protective optical housing fully encapsulates the laser beam and optics system within the ES-405. Do not attempt to disassemble the optical module. Failure to comply with this instruction could cause accidental exposure to laser radiation. The manufacturer certifies that this product operates in compliance with following standards and regulations:

- **FDA / CDRH This product is tested and complies with 21 CFR, Subchapter J, of the health and Safety Act of 1968.**
- **US 21 CFR 1040.10.**

Always power down the system whenever service or repair work is being performed inside the instrument enclosure. Only trained technicians should attempt to repair the ES-405. Routine maintenance does not require removing the instrument from its weatherproof enclosure.

1.5 ES-405 Specifications

PARAMETER	SPECIFICATION
Measurement Principles:	Right angle light scatter detection, using a laser diode as light source.
Number of Mass Channels:	4 (PM _{1.0} , PM _{2.5} , PM _{4.0} , PM ₁₀)
Sample Air Flow Rate:	1.0 LPM
Sheath Air Flow Rate:	1.0 LPM
Flow Control:	Active Volumetric Flow Control
Data Storage Resolution:	0.1 µg/m ³
Data Storage Intervals:	User-Selectable 1, 5, 10, 15, 30, or 60 minutes.
Laser Type:	Diode Laser, 100 mW, 785 nm.
Pump Type:	10,000 hour brushless diaphragm pump.
Power Supply:	Universal 100-240 VAC input, 50/60Hz.
Power Consumption:	1.0 amp @ 12 VDC (12 Watts) average continuous draw with inlet heater running. 0.63 amps (8 Watts) running with inlet heater off.
Operating Temperature:	0 to +50°C
Storage Temperature:	-20° to +60° C
Ambient Humidity Range	0 to 95% RH, non-condensing.
Humidity Control	Automatic 10 Watt inlet heater module controlled to sample RH, with set point.
User Interface:	Menu-driven interface with 4x20 character OLED display and dynamic keypad.
Serial Interface:	RS-232, full duplex serial port for PC or datalogger communications. RS-485, half duplex for modem communications. RS-485, half duplex for sensor communications. USB port for PC communications.
Serial Settings:	Baud = 115200, 8 data bits, no parity, and 1 stop bit. (factory Default) 115200, 57600, 38400, 19200, 9600, 4800, 2400 (selectable).
Alarm Contact Closure:	Normally closed contact closure relay output. Contact rating 1.0A @ 30V DC max.
Compatible Software:	Comet™, terminal programs such as HyperTerminal®
Factory Service Interval:	24 Months typical, under continuous use in normal ambient air.
Mounting Options:	Pole or wall mount bracket standard. Optional EX-905 tripod recommended.
Unit Weight	11.2 lbs
Unit Dimensions	Height: 24" Width: 12" Depth: 6.75"

Specifications may be subject to change without notice.

2 ES-405 SETUP and STARTUP

The ES-405 is designed for rapid deployment and easy setup by a single person in less than 15 minutes in most applications. This section describes the basic assembly, setup, and start-up of the instrument.

2.1 Standard and Optional Accessories

When unpacking a new ES-405, verify that the contents are undamaged. If the shipping cartons are damaged, notify the carrier immediately. Verify that the included accessories are correct and complete. If anything is missing, contact the technical service department at service@metone.com or (541) 471-7111. See the Accessories section at the back of this manual for more details. The normal configuration of the ES-405 is supplied with the following standard accessories:

- Weatherproof TSP inlet with debris screen.
- Instruction manual.
- External power supply and cable.
- USB Cable.
- Grounding Cable.
- Pole/wall mounting bracket.

The following optional accessories may or may not also be included, depending on the order:

- Serial communications cable.
- Aluminum tripod.
- External digital MET sensors.
- External alarm cable.
- External DC power cable for batteries or solar systems.
- Modem kits for phone line, cell, radio, or satellite telemetry.
- Solar power kits (usually drop-shipped from the solar manufacturer). A DC/DC controller is highly recommended to regulate incoming voltage to 12V.

2.2 Mounting Options

Custom Pole or Wall Mounting:

The ES-405 can be mounted to a pole, mast, or wall using the included mounting bracket. The bracket must be screwed or bolted to the pole or wall with appropriate hardware. The enclosed bolts may not be appropriate for the desired mounting. The slot on the back of the ES-405 slips over the tab on the mounting bracket. The tab on the bottom of the ES-405 should also be bolted to the mounting surface to ensure that the unit cannot be knocked off its mounting.

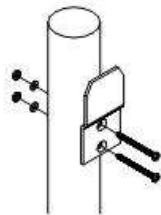

Typical Mounting Bracket Pole Installation

Note: If mounting the unit to a wall, take care to ensure that there is adequate clear space around the inlet to allow unrestricted airflow into the instrument. Wall mounting is often not considered

ideal and not recommended due to the airflow and particulate obstruction of the wall itself. Mount the instrument with no large obstructions nearby whenever possible.

Tripod Mounting:

The Met One EX-905 aluminum tripod is the recommended mounting for the ES-405 for most outdoor applications. It is not included as a standard accessory in order to save expense for users who may not require it. Deploy the tripod as follows:

1. Remove the three stainless steel detent pins from the tripod base by pulling the rings. Unfold the three tripod legs and reinsert the three pins so that each pin secures a leg in the open position. Make sure the erected tripod is rigid and stable.



Detent Pins

2. Lift the ES-405 assembly and slide the slot on the back of the ES-405 over the tab on the top of the tripod. Insert the supplied $\frac{1}{4}$ -20 bolt through the tab on the bottom of the ES-405 and through the hole in the body of the tripod. Secure it with the supplied washers and nut. This prevents the ES-405 from falling or shifting on the tripod.
3. Site the tripod on a surface that is as level as possible. The tripod feet may be secured to the ground or mounting surface with bolts, screws, or tent pegs if necessary. Secure the tripod in windy conditions!

2.3 Setting Up the ES-405

Set up the rest of the ES-405 hardware items and accessories as described below:

1. **Install TSP inlet:** The included weatherproof TSP inlet is simply installed directly onto the top of the ES-405 inlet tube to keep water, insects, and debris out of the instrument. Lubricate the o-rings if necessary. Never operate the ES-405 outdoors without the TSP inlet in place, as the resulting water/debris damage is not covered under warranty.
2. **Optional MET sensor:** If an optional MET sensor is supplied, it may come with a cross-arm tube which mounts to the stud on the top of the EX-905 tripod with supplied fittings. Install the MET sensor on the end of the cross-arm. The sensor should be as far from the ES-405 unit as possible without affecting the tripod balance. If a wind vane is employed, it must be able to rotate fully without hitting anything. Plug the MET sensor into the corresponding connector on the bottom of the ES-405. Consult the separate manual that comes with the MET sensor for alignment details.
3. **AC Power Supply:** If the ES-405 is to be operated on AC line voltage, bolt the power supply to one of the legs of the tripod with U-bolts. Plug the power supply output cable into

the DC power input on the bottom of the ES-405. When the power supply is plugged into AC power, the ES-405 will turn on automatically.

**9441
TSP Cap
(included)**

**Heated Inlet
Assembly
(included)**

ES-405

**905 Tripod
(optional)**

**AC to 12 VDC
Power Supply**

Standard ES-405 Configuration
Not to scale. Some items simplified for clarity.

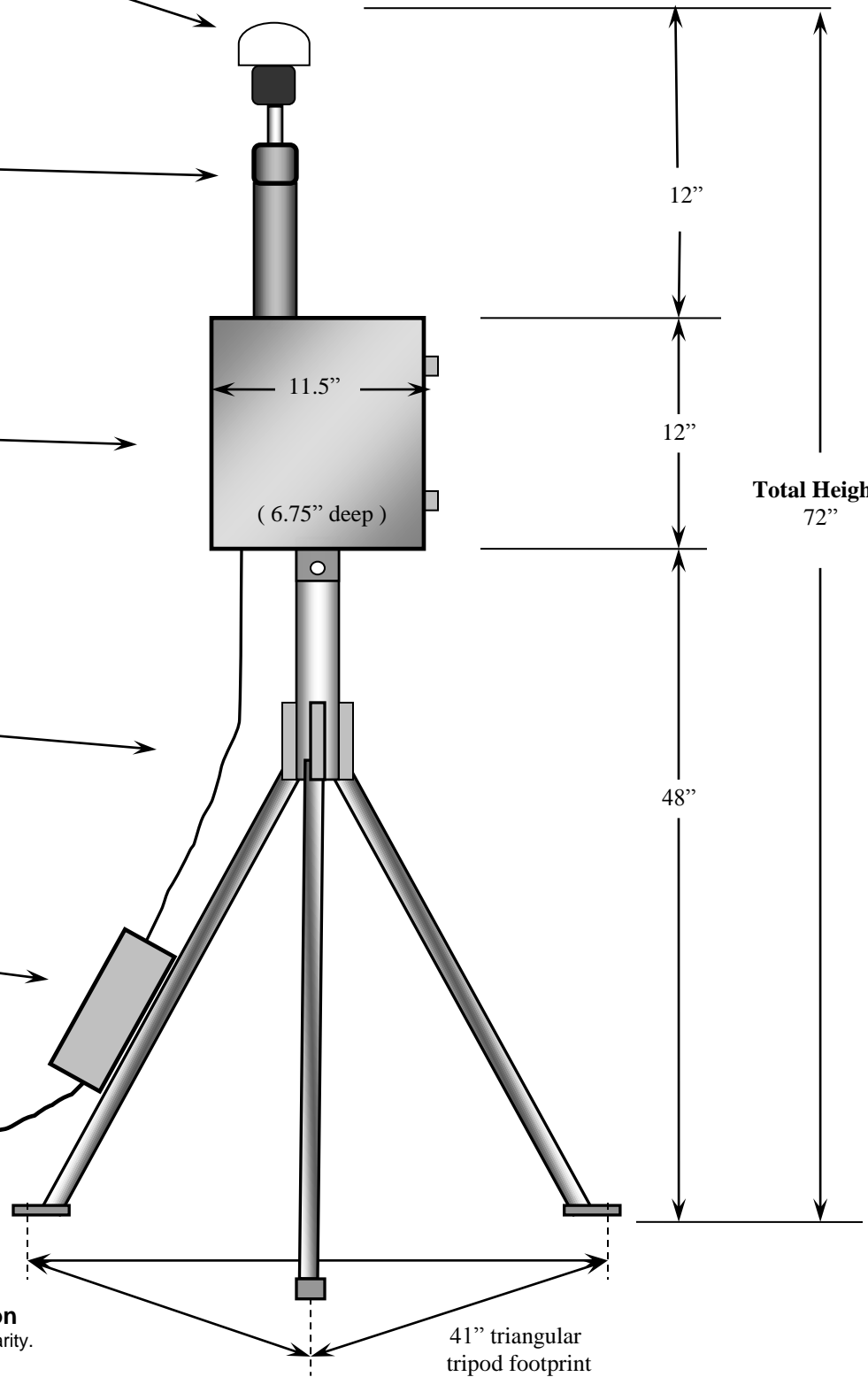

2.4 Electrical Connections

The ES-405 has five weatherproof connectors on the bottom of the enclosure. These connectors provide the connections for the power supply, external sensors, communications, and alarm options. Each connector has a different pin configuration to prevent plugging cables into the wrong connector. The ES-405 will turn on automatically whenever a 12V power source is connected to the power input.

The ES-405 chassis ground lug should be connected to an earth ground with the supplied grounding cable whenever possible, to reduce potential EMI/RFI electrical noise in the unit.

The RS-485 SERIAL connection is for an optional CCS Modem or optional RS-485 half-duplex cable. The RS-485 SENSOR connection is for an optional MET Sensor. The RS-232 SERIAL connection is for RS-232 communications. The ALARM connection is for the optional alarm output.

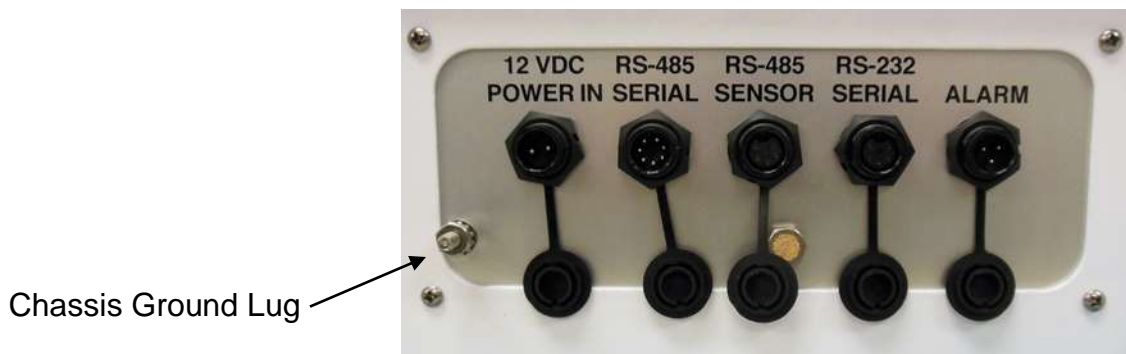

2.5 Power-Up and Starting Operation

As soon as power is applied to the ES-405, the unit will boot up and display ES-405 and company website for a few seconds.

The ES-405 will then default to the OPERATE screen as shown below and begin sampling. Pressing the Enter key on the keypad will bring up the START or STOP screen depending on whether or not the unit is currently sampling.

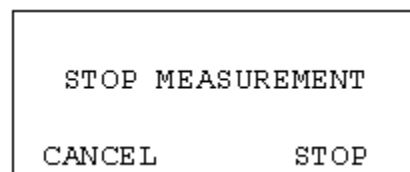
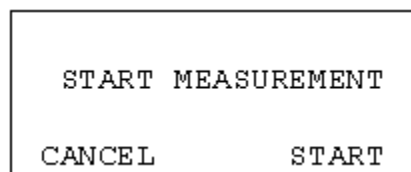

Pressing the ▼ down arrow displays the readings that do not fit on the screen. The MET data will only display if optional digital sensors are connected

2018-08-03 11:34:10	
SAMPLING...	
PM2.5	31.2 ug/m3
PM10	137.8 ug/m3
PM1	26.6 ug/m3
PM 4	51.9 ug/m3
FLOW	1.00 lpm
FT	25.4 C
FP	735.1 mmHg
AT	36.9 C
RH	35.1 %
BP	745.1 mmHg
WS	8.4 m/s
WD	175 deg

2.6 Default Setup

The ES-405 is factory configured to measure continuously with one-minute sample. The following table lists some of the factory default configurations which may need to be changed for your application. See Section 6 for details about the settings.

Parameter	Setting
Sampling Rate	1 minute
Time	Pacific Time
PM1 K-Factor	1.0
PM2.5 K-Factor	1.0
PM4 K-Factor	1.0
PM10 K-Factor	1.0
Baud Rate	115200

3 SITE SELECTION and REMOTE POWER OPTIONS

Use the following criteria when deciding on a sampling location for the ES-405. Always consider the safety and security of the unit, as well as the suitability of the sampling environment.

3.1 Site Selection Requirements

Selection of a proper site for the ES-405 is critical for accurate measurements.

The following is a summary of general ambient particulate monitoring site requirements that will be appropriate for use with the ES-405 in many cases. Some of these criteria may not be appropriate in some applications, due to the versatile nature of the ES-405:

Inlet Height:

- The inlet should be located in the “breathing zone”, between 2 and 15 meters above ground level. When installed on the standard tripod, the ES-405 inlet is positioned two meters above the ground or other mounting surface.
- If the ES-405 is to be collocated with other particulate instruments, such as FRM filter-type samplers or BAM units, then the air inlet must be the same height as the inlet of the other samplers, within one meter vertically. Within one foot is preferred.
- If the ES-405 inlet is the highest point on a building, then lightning rods must be installed to prevent destruction of the unit during electrical storms.

Inlet Radius Clearance:

- The ES-405 inlet should have a one meter radius free of any objects that may influence airflow characteristics, including the inlet of another instrument.
- If an ES-405 is to be collocated at a station along with BAM or FRM samplers, the inlets of each sampler must be no less than one meter apart from each other, and no more than four meters apart. Two meter inlet spacing is recommended where possible.
- If installed near a Hi-Volume sampler, then the distance between the inlet of the ES-405 and the Hi-Vol must be no less than two meters.
- The ES-405 inlet should be located away from obstructions such as short walls, fences, and penthouses, so that the inlet is unobstructed for two meters in all directions whenever possible. In some ES-405 applications, this may not be entirely possible.
- If located beside a major obstruction (such as a building) then the distance between the ES-405 and the building should be equal to twice the height of the building.
- The inlet should be at least 20 meters from the drip line of any overhanging trees.
- There should be at least a 270 degree arc of unrestricted airflow around the inlet. The predominant direction of concentration movement should be included in the arc.

Artificial Particulate Sources:

To avoid possible errors in the concentration measurements, the inlet must be located as far as possible from any artificial sources of particulate, such as blowers, vents, or air conditioners on a rooftop. Especially if any of these types of devices blow air across the inlet of the ES-405. Even sources of filtered air must not blow across the inlet.

Spacing from Roadways:

The ES-405 should usually not be located directly next to a major highway or arterial roadway, as vehicle exhaust will dominate the concentration measurement. This effect can be difficult to predict accurately as shifting winds may direct the plume toward or away from the inlet. An obvious exception would intentional roadside particulate studies.

- Roads with a daily traffic volume of less than 3,000 vehicles are generally not considered major sources of pollutants, and in this case the ES-405 should be located at least five meters from the nearest traffic lane.
- The ES-405 should be located at least 25 meters from any elevated roadway greater than five meters high.
- The unit should be located as far as possible from unpaved roadways, as these also cause artificial measurements from fugitive dust.
- The unit should not be installed in unpaved areas unless year-round vegetative ground cover is present, to avoid the effects of re-entrained fugitive dust.

3.2 Fall Hazard and Security Cautions

If the ES-405 is to be installed more than three meters above ground level, then the tripod legs must be bolted down to prevent the unit from falling to the ground. An accidental fall may cause major optical system damage requiring that the unit be returned to the factory for repairs. In addition, dropping the ES-405 from any height will cause a potential safety hazard for those below, and may damage the unit beyond repair.

The ES-405 tripod should be secured to the mounting surface in windy conditions to prevent the unit from falling over, even at ground level. This is especially important in winds over 30 mph. If bolt-down is not possible, then the tripod legs may be weighted down with sand bags or cinder blocks to secure the unit. Wind or fall damage is not covered under warranty.

The ES-405 should be secured from theft or vandalism to the extent possible. A limited-access rooftop or a fenced lot are often good places to deploy the unit. Solar panels and batteries are highly susceptible to theft and should be secured.

3.3 Confined Sampling Locations

Because of the portable and versatile nature of the unit, the ES-405 is sometimes deployed in confined or non-ambient locations to monitor localized particulate sources, such as tunnels, mines, quarries, shopping malls, train stations, etc. Each of these applications is unique and presents various challenges. We recommend that you contact a Met One Service representative to determine the suitability of the unit if you plan a custom deployment like this. In any case, the safety of those around the unit is paramount, and the protection of the unit from damage is very important.

4 ES-405 USER INTERFACE and MENU SYSTEM

This section describes the ES-405 user interface system, and describes the functions of the main menu options, including how to view data and errors.

4.1 The User Interface - Keypad and Display Functions

The ES-405 user interface consists of a 4x20 character organic light-emitting diode display (OLED) and a dynamic keypad. The two white keys under the display are called “soft keys”. These are dynamic keys which change in response to a menu option displayed directly above the key on the bottom row of the display. The function of these keys depends on which menu is shown on the display and are often used for functions such as “SAVE” and “EXIT”.

The four, red arrow (cursor) keys are used to scroll up, down, left, and right, to navigate in the menu system, and to select items or change fields on the screen. The arrow keys are also often used to change parameters or increment/decrement values in the menu system. The right arrow key can be used to wake up the display if it has turned off to save power.

The MENU key is used to enter the main menu or to select an item in a list. The ESC key is used to escape or exit out of a menu.



ES-405 Keypad and Display

4.2 Using the Main Sampling Screen

The ES-405 display shows the Operate screen when the unit is in normal operation. The active display area shows the current date and time and most recent measurement concentration. Not all the parameters monitored by the ES-405 can fit on the screen, press the down ▼ arrow to view the remaining parameters. The date and time will remain at the top of the display at all times.

2018-08-03 11:34:10		Visible display area showing current parameters
SAMPLING...		
PM2.5 31.2 ug/m3		
PM10 137.8 ug/m3		Scroll down ▼ to view the other current sensor parameters
PM1 26.6 ug/m3		
PM 4 51.9 ug/m3		
FLOW 1.00 lpm		
FT 25.4 C		
FP 735.1 mmHg		
AT 36.9 C		
RH 35.1 %		
BP 745.1 mmHg		
WS 8.4 m/s		
WD 175 deg		

Main Sampling Screen

Below is a table which describes the parameters visible in the main sampling display as shown above. These are all the logged parameters in the ES-405. The active display shows the 1-second real-time value for each parameter, while the stored data shows the average value over the user-selected logging interval. AT, RH, BP, WS and WD are only visible if an external digital MET sensor is attached.

Parameter	Description
PM2.5	Real-time particulate concentration, in micrograms per cubic meter.
PM10	Real-time particulate concentration, in micrograms per cubic meter.
PM1	Real-time particulate concentration, in micrograms per cubic meter.
PM4	Real-time particulate concentration, in micrograms per cubic meter.
FLOW	Real-time sample flow rate, in actual liters per minute.
FT	Internal temperature in degrees C.
FP	Internal barometric pressure in mmHg.
AT	External ambient temperature in degrees C (if equipped).
RH	External ambient relative humidity (if equipped).
BP	External ambient barometric pressure in mmHg (if equipped).
WS	Wind speed in meters per second (if equipped).
WD	Wind direction in degrees (if equipped).

The Main ES-405 screen

Pressing the Enter key while in the Operate screen will either bring up the Start or Stop screen depending on whether the instrument is currently sampling or not.

```
START MEASUREMENT
CANCEL          START
```

```
STOP MEASUREMENT
CANCEL          STOP
```

4.3 Using the Main ES-405 Menu System and Clearing Memory

MENU SCREEN: The first line of the Menu screen is Start or Stop depending on whether the instrument is currently sampling or not.

```
STOP SAMPLE
SETUP MENU
CALIBRATE MENU
ALARMS
ABOUT
```

The main ES-405 menu system can be entered at almost any time by pressing the MENU key. Use the ▲ ▼ arrow keys to select the desired menu option, then press the MENU key to enter the selected sub-menu. The functions in the SETUP and CALIBRATE menus are described in Section 6 and 7.

SETUP: This is the setup menu for the ES-405. All the setup parameters in this menu are described in Section 6.

CALIBRATE: This is the field calibration menu for the ES-405. All the calibrations and tests in this menu are described in Section 7.

ABOUT: This menu option displays the ES-405 model number, firmware version and revision, and serial number as shown in the example below. Press the MENU/SELECT key to return to the main menu.

```
ES-405
83904 R1.2.0
X15465
WWW.METONE.COM
```

5 ES-405 MEASUREMENT METHOD

The Met One Instruments, Inc model ES-405 is a type of air quality sensor which automatically measures and records real-time airborne PM₁₀, PM₄, PM_{2.5}, and PM₁ particulate concentration levels using the principle of right-angle laser light scatter. This section describes the measurement systems.

5.1 Sheath Air

The Particle Profiler uses a sheath air system. When a particle counter is to be used to sample aerosols containing high concentrations of particles, the sensor should incorporate sheath air to prevent particles from contaminating the internal optics of the sensor. The particle laden sample air is enclosed in a sheath of clean filtered air that prevents particles from escaping. Sample air is drawn into the ES-405 by an internal pump. Flow rate is controlled with a flow sensor to maintain constant 1 LPM flow on the inlet nozzle. Additional air is added around the sample flow to contain the particles.

5.2 Detection

The ES-405 is always ready to detect particles. Sample air is drawn into the detector chamber and subjected to an intense laser beam located at right angles to the flow. The laser beam has been shaped to produce a flat very thin beam, producing a small sample area. Light travels through the sample stream and terminates in the light trap. Particles pass through the laser beam and scatter light. The amount of light scattered is proportional to the size of the particle. A portion of this light scatters toward the elliptical mirror. This light is then directed to the detector. The output of the detector is then analyzed to determine the number of particles and the size of the particles. Detected particles are multiplied by a fixed density to provide an indicative particulate mass measurement.

5.3 Sizing and Counting

The amount of scattered light is converted to a voltage pulse and based on the amplitude of the pulse signal it will pass through one or more of the size discriminators and into the associated counter(s).

5.4 Calibration

Calibration is performed using ideal (PSL) spheres, which provide a powerful tool for assessing the sensitivity, accuracy, resolution and false count level. The particle detector is compared to a reference mono-dispersed (single size) suspension of polystyrene latex (PSL) spheres in clean filtered air for both calibration and certification of performance specifications. This calibration technique serves two purposes:

1. Provides a standard traceable reference.
2. Provides a measure of how well the unit maintains its calibration (reproducibility).

5.5 K-Factor

The AQ Mass Profiler's PSL sphere calibration provides an extremely consistent calibration but does not generally match the characteristics of all ambient particulate. A K-Factor (multiplier) must be established for good accuracy and correlation to collocated instruments.

It is best to compare the ES-405 to regulatory monitors distinguished as Federal Reference Monitors (FRM) or Federal Equivalent Monitors (FEM). Contact your local air quality authorities for information on locations and how to access the data. Some sites may have hourly data, while others may have 24-hour data.

Calculate the K-Factor for each particulate size fraction as the reference concentration divided by the ES-405 light scatter concentration over the same time period. For example, if the reference total concentration was $51 \mu\text{g}/\text{m}^3$ and the ES-405 total concentration was $38 \mu\text{g}/\text{m}^3$, then the K-Factor would be 51 divided by 38 or 1.342. If only one size fraction K-Factor will be calculated for the unit it is advisable to use this number for all four PM sizes.

The K-Factor is only valid at the same site and for the same particulate type. If the local particulate source changes, the K-Factor may no longer be valid. The accuracy of the mass output can be affected by variations in size, color, shape, and index of refraction of the sampled particles. The K Factor for each PM mass fraction can be set in the calibrate menu.

5.6 Sample RH Control for Light Scatter Mass

The relative humidity (RH) of the sample air has an influence upon the measurement of particulate mass by optical units. At RH values greater than about 50% this effect begins to increase due to particle aggregation and particle size increases as water is absorbed. The ES-405 mitigates this through a heated inlet tube that uses an internal sample RH sensor. The RH of the incoming air is measured, and the inlet heater is turned on whenever the user-set setpoint is exceeded (typically 40% RH).

6 SETUP MENU DESCRIPTIONS

The ES-405 has a system of setup menus which contain all of the settings and parameters needed to perform the measurement and operation of the unit. Many of these settings are set at factory default values which are correct for most applications but may be altered by the operator to suit the specific needs of your monitoring program. This section describes the SETUP menu in detail and should be reviewed to ensure desired operation. Once set, most of the values in the SETUP menus will not need to be changed by the site operator. The settings will not be lost if the unit is unplugged or powered down.

The SETUP menu can be accessed through the main ES-405 menu. Use the arrow keys to select SETUP option in the main menu, then press the MENU key to enter the menu.

```
STOP SAMPLE
SETUP MENU
CALIBRATE MENU
ABOUT
```

Use the ▲ ▼ keys to select the desired sub-menu and press the ENTER key again to enter. The top SETUP menu is shown below:

```
SAMPLE
CLOCK
SERIAL PORT
MEMORY
ALARM OUTPUT
```

6.1 SAMPLE Setup

Set the Sample Rate and Location ID

```
SAMPLE RATE: 5 MIN
LOCATION: 001
```

The Sample Rate choices are a pick list with the following choices.

```
SAMPLE RATE:  1 MIN
               5 MIN
              10 MIN
              15 MIN
              30 MIN
              1 HR
```

6.2 CLOCK Setup

Press the ENTER key. Scroll left and right to access each field to edit. Use the Up/Down arrows to change each field as it flashes. Press ENTER key when complete, then press the soft key under SET to finish.

```
SET CLOCK
2018-08-03 11:45:31

SET
```

6.3 SERIAL PORT

Set the baud rate for RS-232 and USB serial communication.

```
BAUD: 115200
```

Baud rate choices are a pick list with the following choices:

```
BAUD: 2400
      4800
      9600
      19200
      38400
      57600
      115200
```

6.4 MEMORY

Allow to clear the files.

```
FILE: ALL LOGS

CLEAR
```

Choices

```
FILE: DATA LOG
      ALARM LOG
      ALL LOGS
```

6.5 ALARM OUTPUT

This screen is used to establish the rules for activating the alarm contact closure relay output of the ES-405. This contact closure connection is located on the bottom of the enclosure and requires an optional cable with the contact wires routed out. The contacts are normally open/normally closed and will close/open when the event is triggered. This can be used to signal an external warning light, logic controller, or logger input to take some action. The optional external alarm cable (MOI part number 83569) relay wiring function is as follow:

Red=Normally Open, Black=Normally Closed, Green=Common.

Select the OUTPUT SOURCE, OUTPUT TIMING, or PM LIMITS screen as shown below.

OUTPUT SOURCE
OUTPUT TIMING
PM LIMITS

The alarm OUTPUT SOURCE can be set to ALARM EVENT or PM LIMIT. Setting ALARM EVENT means that any instrument error or alarm will activate the output. The PM LIMIT setting is real-time concentration threshold that will trigger the alarm and can be set from 0.1 to 999.9 $\mu\text{g}/\text{m}^3$ for each PM size.

Press the ENTER key. Use the Up/Down arrows to select the source. Press ENTER key.

SOURCE: PM LIMIT

The OUTPUT TIMING screen is used to set how long the alarm signal is ACTIVE when triggered (1 to 60 seconds) and how much delay time must pass before the alarm can be reactivated again (1 to 60 minutes).

ACTIVE: 10 SEC
DELAY: 01 MIN

The PM LIMITS screen is used to set the individual PM trigger Levels for each of PM1, PM2.5, PM4 and PM10. Setting the trigger level to 0 will disable triggering of the output for the specified PM Level.

Press ENTER to begin and end editing the PM limit for each mass size.

PM1: 000.0 $\mu\text{g}/\text{m}^3$
PM2.5: 000.0 $\mu\text{g}/\text{m}^3$
PM4: 000.0 $\mu\text{g}/\text{m}^3$
PM10: 000.0 $\mu\text{g}/\text{m}^3$

7 CALIBRATE MENU – FIELD CALIBRATIONS

The ES-405 has a system of calibration menus which allow the operator to audit or calibrate the airflow control system parameters for optimal performance. These parameters are often audited monthly and calibrated quarterly during continuous operation. The exact frequency may vary depending on the harshness of the local conditions and the data validation requirements established by the sampling program administrator and your resulting standard operating procedures (SOP).

The CALIBRATE menu is located in the main ES-405 menu. Use the arrow keys to select CALIBRATE option in the main menu, then press the ENTER key to enter the menu. Use the ▲▼ keys to select the desired sub-menu and press the ENTER key again to enter. The top CALIBRATE menu is shown below

7.1 CALIBRATE Menu

```
CALIBRATE FLOW
CALIBRATE FP
K-FACTORS
```

7.1.1 CALIBRATE Flow Screen

```
SET POINT: 1.0 lpm
      FLOW: 1.00 lpm
STANDARD: 1.00
DEFAULT CALIBRATE
```

The SET POINT parameter is the target flow rate that the ES-405 will attempt to maintain.

The FLOW parameter is the current reading from the ES-405 flow sensor, in actual volumetric liters per minute. The ES-405 should automatically regulate to the setpoint (1.0 LPM) when the flow calibration screen is entered. This may take a moment.

The STANDARD parameter is where you can enter the correct value from your traceable flow meter, using the arrow keys. **The flow reading that you enter must be in actual conditions.** The FLOW value should change to match the STANDARD value when you press the CALIBRATE soft key.

The DEFAULT soft key can be pressed to clear out all previous field calibrations and restore the factory calibration for the sensor. Use this if difficulty is encountered during the calibration. Press ESC to escape without changes.

Note: To audit the ES-405 flow rate without changing the calibration, simply compare the FLOW value to your traceable standard and record the results. If the CALIBRATE soft key is not pressed, then no flow calibrations are affected.

7.1.2 CALIBRATE FP Screen

```
FP: 731.3 mmHg
STANDARD: 731.3 mmHg

DEFAULT  CALIBRATE
```

The FP parameter is the current reading from the ES-405 pressure sensor. The STANDARD parameter is where you can enter the correct value from your traceable pressure standard, using the arrow keys. You will need to convert units if your standard outputs pressure in other units. The FP value should change to match the STANDARD value when you press the CALIBRATE soft key. The DEFAULT soft key can be pressed to clear out all previous field calibrations and restore the factory calibration for the sensor. Use this if difficulty is encountered during the calibration. Press ESC to escape without changes.

7.1.3 K-FACTOR Screen

Press Enter to begin and end editing the K-Factor value for each mass size.

```
PM1    K: 1.000
PM2.5  K: 1.000
PM4    K: 1.000
PM10   K: 1.000
```

8 MAINTENANCE and TROUBLESHOOTING

This section provides information about routine maintenance of the ES-405, and for performing more detailed diagnostic tests if a problem is encountered. The ES-405 generates error messages on the display or in the data log if a failure or other problem is detected. Many times, there is a simple solution. Persistent errors often signify a failure which will require investigation.

WARNING: The ES-405 Particulate Profiler can only be serviced or calibrated by factory-authorized personnel. Unauthorized maintenance on the Particle Profiler may result in exposure to laser radiation that can cause blindness and void warranty.

The ES-405 is an extremely component-dense assembly! Only skilled and trained electro-mechanical technicians should attempt any disassembly or repairs inside the ES-405. Routine maintenance procedures do not involve removing the ES-405 assembly from the enclosure. Calibrating particle sensors like the one in the ES-405 Particle Profiler requires specialized equipment and a skilled technician. Met One Instruments maintains a calibration facility for calibrating particle counters according to industry-accepted methods using NIST traceable standards. The ES-405 Particle Profiler should be calibrated on a 24 month basis.

8.1 Basic Problem and Cause/Solution Table

The following table contains information on some of the more common ES-405 problems which may be encountered, and some steps to identify and remedy the problems. Met One welcomes customer suggestions for new items to include in this section of future manual revisions. If the solution cannot be found in the following table, then contact one of our expert service technicians for help in resolving your problem.

Problem:	The ES-405 won't start a measurement cycle.
Cause/Solution:	<ul style="list-style-type: none"> You must press the START SAMPLE key to start continuous operation. The unit will not start a cycle if the input DC voltage is below the restart threshold, such as 10 volts DC.

Problem:	Flow failures or low flow.
Cause/Solution:	<ul style="list-style-type: none"> Check the filter. This must be replaced periodically. Try to DEFAULT the flow sensor calibration. If corrupted flow cal parameters are entered into the flow calibration, it may appear that the flow system is not working. Verify the internal AT and BP sensors function. They appear as FT and FP on the main screen when their output is enabled. Failed sensors can affect the flow. The sample pump itself will eventually wear out and need to be replaced. It should last at least a year under normal conditions. Check the other possibilities first.

Problem:	Optical system alarms and failures
Cause/Solution:	<ul style="list-style-type: none"> The ES-405 must be periodically returned to the factory for optical system cleaning. The period will depend on your particulate levels. Check the filter and replace as needed. The laser diode has a finite lifetime which will be reduced at high temperatures. It may eventually fail and need to be replaced at the factory.

Problem:	The ES-405 data does not match BAM or FRM data at the same site
Cause/Solution:	<ul style="list-style-type: none"> • A K-Factor (multiplier) <u>must</u> be established for good accuracy and correlation to collocated instruments. The K-Factor will sometimes be very significant, such as a multiplier of 3 or 5. See Section 5.5. • The K-Factor is only valid at the same site and for the same particulate type. If the local particulate source changes, the K-Factor may no longer be valid. • The ES-405 TSP inlet is designed for low winds only. High winds may cause a cut-point in the TSP inlet itself. • Clean the TSP inlet monthly. • Check the sample RH data and filter RH sensor operation. High sample RH will cause ES-405 over-reading. The sensor itself can occasionally fail. • Check the ES-405 for flow calibration problems. • Check the alarm log for optical system alarms.

8.2 Suggested Periodic Maintenance Intervals

The following table shows the Met One recommended period for routine maintenance items. Some of these items will need to be performed more, or less, often depending on the exact characteristics of your location. The program administrator should review these items and establish SOPs appropriate for your application.

Maintenance Item	Suggested Period
AQ Flow Audit/Calibration	Monthly
Calibrate Sensor	24 Months
TSP Cleaning	Monthly
Replace Filter	Yearly

8.3 AQ Flow Calibration

Connect a flow meter to the inlet nozzle of the ES-405 Particle Profiler and allow the flow to stabilize. If it is not 1.00 LPM \pm 0.02LPM, then it needs to be calibrated. Refer to Section 7.1.1.

8.4 Filter Change

The filter cartridge is located in the front panel of the instrument. It can be removed by unscrewing the black Delrin filter holder. The expected lifetime of the filter is one year, but in heavy particulate areas they may need to be replaced more often. The replacement filter p/n is 580358.

8.5 TSP Inlet Cleaning

The TSP inlet must be cleaned periodically. The time interval between cleanings varies depending on the local particulate levels. The TSP inlet should be disassembled and cleaned at least every three months during continuous use.

The TSP inlet can be disassembled for cleaning by removing the three screws in the cap. Soap and water often work best for cleaning the TSP inlet and debris screen. Do not over-tighten the screws during reassembly or the plastic threads will strip out.

8.6 Factory Service Interval

The ES-405 needs to be periodically returned to the factory for service and recalibration. The recommended period is 24 months during continuous use. However, some users establish their own interval depending on the harshness of the sampling conditions, particulate levels, and data scrutiny. High concentration operation will often require more frequent factory service.

Factory service primarily consists of optical system cleaning, laser/detector checks, and recalibration. As-found calibration checks can also be requested. Contact the Met One technical service department to schedule ES-405 service. A Return Authorization (RA) number must be obtained before the unit is returned.

9 DATA RETRIEVAL and COMMUNICATIONS

This section describes the methods used to retrieve data files from the ES-405. The unit has a single serial data output which can be routed through the RS-232 data port or the USB serial port, and may be used with a local computer, laptop, or digital datalogger. An RS485 output is available for connection to the CCS modem to allow remote data viewing and collection. Access to the data through the serial port is easy using the Comet software or simple terminal or escape commands.

9.1 Serial Port Connections to a Computer

The ES-405 can be directly connected through the supplied USB cable to most standard desktop computers and laptops. The USB port is located behind the front door, in the bottom right of the unit.

The ES-405 can be directly connected through the purchased serial cable to desktop computers that have a 9-pin (DB-9) RS-232 serial port connector.

The ES-405 default settings are 115200 Baud, 8 data bits, no parity, one stop bit, no flow control. The baud rate may be changed to a slower rate. The other communications settings are fixed.

9.2 Modem Options for Remote Data Retrieval

Met One Instruments CCS cloud display and storage cell modem is recommended for remote access to the ES-405. Contact Met One for details.

9.3 Comet™ Data Retrieval Software

The ES-405 is compatible with the Comet™ program, which is a simple Windows-based communications terminal program developed by Met One Instruments. This is the recommended method for all ES-405 data retrieval, since Comet allows the user to easily download the data logs, error logs, and settings files from the ES-405 without the user having to know any of the underlying communications protocols. A comprehensive pdf user's manual for the program is also available from the Met One Instruments website. Install the program onto the computer that will be used for data retrieval and review the manual for complete data examples.

Note: If the Comet software is being used for data retrieval, none of the terminal mode commands shown in the following sections of this manual will be needed.

Comet is a communications terminal program which can retrieve data from the ES-405 using either a direct local connection or a remote connection via various modem types or even an IP address.

Warning: A Silicon Labs CP210x Driver for the USB connection must be installed before connecting to the USB Type B port.

Driver download weblink: <https://www.silabs.com/products/development-tools/software/usb-to-uart-bridge-vcp-drivers>

Note: Before using the USB Type B port, ensure an existing RS-232 connection is disconnected.

The Comet program is available from the Met One Instruments website: <https://metone.com/products/comet/>

Install the program on the computer, then run it from the Programs directory. Create a new station for the ES-405 and then use it to retrieve the data from the ES-405 monitor.

The Comet program has a “Terminal” button which provides access to the ES-405 just as when using any other terminal program.

9.4 Downloading Data Using a Terminal Emulator

ES-405 data can also be easily downloaded through the serial port using a terminal emulator program, like PuTTY. Connect the serial port of the ES-405 to your computer or laptop serial port using the supplied serial cable.

Importing the raw text file into a spreadsheet:

The data saved in a text file from a terminal download can be viewed by simply opening the text file. However, the data is often hard to view in the raw text format due to the comma-separated layout of the data fields. The easiest way to analyze the data is to open it as a .csv file into a spreadsheet program such as Excel®:

1. Open the spreadsheet program.
2. Select to open the downloaded file. The program should prompt you how to delimit the fields. Select comma.
3. The text file can be opened directly with Excel or similar software. Each data parameter should appear in its own spreadsheet column, with the correct data header at the top of each column. You can then save the file as a spreadsheet file if desired.

9.5 Data Retrieval Commands Through the Serial Port

When a serial connection between the computer terminal program and the ES-405 has been established, you will have access to the ES-405 data files by sending the following commands through the serial port with keyboard strokes or ASCII characters.

There are two modes of communication:

1. User communication – This is a user interactive mode using simple letter commands for ease of use.
2. Computer communication – This mode is used for computer-to-device communication. It has a level of data integrity.

9.5.1 User Communication

In the user communication mode (terminal mode), press the Enter key, <cr>, three times to enter the mode. In this mode simple character commands can be issued with no <Esc> character required.

An asterisk character appears during wake-up and after a command has completed. The asterisk indicates that the instrument is ready for a new command.

Commands are echoed back from the instrument in this mode. Commands are terminated by the Enter key <cr>.

A help menu can be viewed by sending H, h, or ?; giving all the commands available to the user. Pressing <Esc>, X<cr> or Q<cr> will exit user mode

Note: After a few minutes, the ES-405 will stop waiting for a command and you will have to send another series of three carriage returns to reestablish the command prompt connection.

9.5.2 Computer Communication

In the computer communication mode, the command format has an optional level of data integrity – checksum. This is enabled whenever an <Esc> character is sent to the instrument. Character echo is suppressed in this mode.

9.5.3 Computer Command Format

The computer command has the following format:

```
<Esc>Cmd p1 p2*cs<cr>
```

Computer commands are prefaced with an <Esc> (0x1B) character followed directly by a command, Cmd, which is variable in length depending on the command. After the command characters there can be zero or more parameter fields, p1 p2. Each parameter field is delimited by one or more Space characters (0x20).

A computer command example follows:

```
<Esc>rv
```

```
ES-405, 83904, R1.2.0.0a
```

9.5.4 Checksum Computation

Checksum is calculated as the 16 bit unsigned integer sum of all characters after the <Esc> character up to but not including the Checksum Delimiter Character * (0x2A). It is printed out as an ASCII decimal number.

The result is always 5 characters in length with leading zeros.

A valid checksum may be signaled in the following manner: *//<cr>

A computer command example follows:

```
<Esc>rv*//
```

```
ES-405, 83904, R1.2.0.0a*01278
```

9.5.5 Serial Command List

The command set descriptions are listed in the following table:

Command	Function																		
#	Get MetRecord revision.																		
1	Report settings.																		
2	Report All data.																		
3	Report New data.																		
4	Report Last data.																		
7	Alarm Report																		
E	End (Stop) sample cycle.																		
H, ?	Help menu.																		
S	Start a sample cycle.																		
Q	Exit User mode and enter Computer mode.																		
DT	Get/Set date and time. yyyyMMddHHmmss																		
ID	Get/Set location ID or address. The range is 1 to 999.																		
MA	Modbus Address. The range is 1 to 247.																		
OI	Interval Output On/Off. 1=Enabled, 0=Disabled.																		
QH	Query Header																		
RF	Reference flow for calibration																		
RO	Report Options. Uses bit flags for the different readings. Add up all the bit flags for combinations needed <table border="1"> <thead> <tr> <th>Reading</th> <th>Bit</th> <th>Add</th> </tr> </thead> <tbody> <tr> <td>Flow</td> <td>0</td> <td>1</td> </tr> <tr> <td>Temperature (FT)</td> <td>1</td> <td>2</td> </tr> <tr> <td>Pressure (FP)</td> <td>2</td> <td>4</td> </tr> <tr> <td>RH (FRH)</td> <td>3</td> <td>8</td> </tr> <tr> <td>Met Sensor</td> <td>4</td> <td>16</td> </tr> </tbody> </table> e.g. RO 11 = Flow, Temperature, RH	Reading	Bit	Add	Flow	0	1	Temperature (FT)	1	2	Pressure (FP)	2	4	RH (FRH)	3	8	Met Sensor	4	16
Reading	Bit	Add																	
Flow	0	1																	
Temperature (FT)	1	2																	
Pressure (FP)	2	4																	
RH (FRH)	3	8																	
Met Sensor	4	16																	
RQ	Request last reading.																		
RV	Get product information.																		
SB	Get/Set serial baud rate. 3=2400, 4=4800, 5=9600, 6=19200, 7=38400,8=57600,9=115200.																		
SK	Set PM K Factors. K Factor range is 0.1-20.0. PM1=1, PM2.5=2, PM4=3, PM10=4																		
SM	Set Mode 0-Single, 1-Repeat, 2-Logger																		
SPR	RH Setpoint to turn inlet heater on.																		
ST	Get/Set Sample Time in Seconds.																		

9.6 Serial Command Explanations

9.6.1 User Data Report

The 2, 3, 4 and RQ commands will print the User Data Report.

The Time field is the standard ISO style time stamp. The optional fields follow. The Met bit is active for this report and if set will include WS, WD, AT, RH and BP at the end of the record.

The Data Report without Met bits enabled is as follows:

Time,PM1(ug/m3),PM2.5(ug/m3),PM4(ug/m3),PM10(ug/m3),FLOW1(lpm),FT(C),FP(mmHg),FRH(%)

2020-06-11 12:19:00,000.5,001.8,004.9,019.7,1.00,+37.6,659.0,11.1

9.6.2 OI Command

When OI is set to 1, the unit will volunteer a record after each sample period similar to the User Data Report.

9.6.3 SK Command

This is used to set the K factors for each PM size. PM1=1, PM2.5=2, PM4=3, PM10=4. It is entered as SK (PM#) (K factor). A typical command and response for each PM size is as follows.

```
*SK 1 3.78
```

```
SK 1,3.78,PM1
```

```
*SK 2 2.70
```

```
SK 2,2.70,PM2.5
```

```
*SK 3 2.70
```

```
SK 3,2.7,PM4
```





```
*SK 4 2.16
```





```
SK 4,2.16,PM10
```

10 PARTS and ACCESSORIES

10.1 Consumables, Replacement Parts, and Accessories

The following parts are available from Met One for maintenance, replacement, service, and upgrades. If unsure about a part you need, please contact the technical service department. Some of these parts may require technical skills or special instructions before use or installation.

Description	Part Number	Graphic
Sample Pump Module Assembly	81643	
Flow Sensor, Differential Pressure	82258-1	
Temperature Sensor Assembly and Harness	80957-2	
Air Filter, 0.01 micron	580358	
O-Ring, Filter Holder	720074	
Pole Mount Bracket	9425	
TSP Sampling Inlet Harsh environment, with insect screen and rain cap	9441	
OLED Display, 20x4 Character	701751	
Profiler Engine Assembly	83120	
Power Supply, 100-240 VAC input 12 VDC output, Weatherproof	9438-4	
RS-232 Communication Cable	83245	
RS-485 Communication Cable	83179	
USB Cable	500784	
External Alarm Cable	83569	
Solar Power Kit, 160W, 3.7 minimum PSH	730139	
Solar Power Kit, 240W, 2.5 minimum PSH	730140	
ES-405 Factory Service and Recalibration		Call Met One

Description	Part Number	Graphic
Combination Sensor for Ambient Temperature, Relative Humidity, and Barometric Pressure	597A	
Combination Sensor for Wind Speed and Wind Direction	EX2-034	
Combination Sensor for Sonic Wind Speed and Wind Direction	EX2-AIO	
Comet Cloud Service Modem	CCS Modem 2	

10.2 Combination Sensor Options

The ES-405 can be equipped with optional combination wind speed and direction, ambient temperature, relative humidity, and barometric pressure sensor. There are both analog and sonic type sensors available. Ensure the ES-405 is powered down before connecting a new sensor to the unit.

10.2.1 EX2-034

The EX2-034 is a mechanical cup and vane sensor that provides wind speed and direction measurements. It is mounted to the ES-405 tripod using the provided cross arm. It connects to the ES-405 RS-485 SENSOR connector using the included signal cables and analog to digital signal converter. This converter measures the wind sensor's analog signals and provides an RS-485 digital output to the ES-405 with wind speed and direction values. This type of sensor requires manual orientation when deployed. Consult the separate manual that comes with the wind sensor for details.

10.2.2 EX2-AIO

The EX2-AIO sensor provides sonic wind measurements. It is mounted using the same cross-arm assembly as the EX2-034B in. However, it has a different adapter to mate it to the cross-arm itself.

It connects to the ES-405 through the RS-485 SENSOR connector on the bottom of the monitor. This connection both provides power to the sensor and collects its digital output string to provide wind speed and direction information.

This type of sensor includes an internal compass for wind direction correction and does not require manual orientation when deployed. Consult the separate manual that comes with the wind sensor for details.

10.2.3 597A

The 597A measures ambient temperature, relative humidity, and barometric pressure. It connects to the ES-405 through the RS-485 SENSOR connector

10.3 CCS Modem

The Met One Instruments, Inc. Comet Cloud Service (CCS) modem provides real time remote connectivity to the ES-405. A personalized webpage dashboard gives current measurement values graphically and in tabular form. The private link can be shared with other authorized users allowing easy data sharing across an organization. Data is stored in the cloud for 2+ years and can be downloaded to a computer or other device at any time. It connects to the ES-405 through the RS-485 SERIAL connector.

