

OPERATION MANUAL

SASS/SuperSASS

Speciation Sampler
SASS-9805
Rev C



POWERED BY ACOEM

Met One Instruments, Inc.
1600 NW Washington Blvd.
Grants Pass, OR 97526
Telephone: (541) 471-7111
Facsimile: (541) 471-7116
metone.com



POWERED BY ACOEM

Met One Instruments, Inc. is now part of the Acoem international group of companies.

Met One Instruments has been designing and manufacturing class-leading meteorological, ambient air sensing, and air quality monitoring instrumentation since its inception in 1989. Its line of robust industrial-grade meteorological equipment, air particulate monitoring equipment, and indoor air quality monitoring systems have set the standard for the industry. Headquartered in Grants Pass, OR, Met One Instruments, Inc. is fueled by a dedicated expert team who is diligently working to advance the technology required to ensure continued improvements in human and environmental health now and for generations to come.

Acoem is committed to helping organizations and public authorities find the right balance between progress and preservation – safeguarding businesses and assets and maximizing opportunities while conserving the planet’s resources. Headquartered in Limonest, France, Acoem delivers unrivaled inter-operable AI-powered sensors and ecosystems that empower our customers to make enlightened decisions based on accurate and timely information.

In 2021, Acoem acquired Met One Instruments, marking a pivotal moment when two industry leaders in the air quality monitoring sectors converged – creating a single, stronger and more future-focused provider of holistic environmental monitoring solutions. Now, **Met One Instruments Powered by Acoem** has opened new possibilities through an extensive offering of class leading, multi-parameter environmental monitoring and industrial reliability solutions. These integrated measurement systems, technologies, and services deliver comprehensive solutions for a range of applications, including environmental research, regulatory compliance, and industrial safety and hygiene.

For more information about **Met One Instruments Powered by Acoem**, please visit: metone.com

For more information about Acoem, please visit: acoem.com

SASS Operation Manual - © Copyright 2024 Met One Instruments, Inc. All Rights Reserved worldwide. No part of this publication may be reproduced, transmitted, transcribed, stored in a retrieval system, or translated into any other language in any form without the express written permission of Met One Instruments, Inc.

Table of Contents

1. INTRODUCTION	8
1.1 About This Manual	8
1.2 Technical Service	8
1.3 SASS/SuperSASS _{2.5} Ambient Chemical Speciation Sampler.....	9
1.3.1 SASS/SuperSASS Overview	10
1.4 SASS/SuperSASS Specifications.....	11
2. SITE SELECTION and POSITIONING CRITERIA	13
3. SETUP	14
3.1 Unpacking The SASS	14
3.1.1 Shipping Damage	14
3.1.2 Shipment Contents	15
3.2 Electrical Service	17
4. ASSEMBLY and DEPLOYMENT	18
4.1 Tripod Assembly.....	19
4.1.1 Tripod Leg Deployment.....	19
4.1.2 Securing the EX-905 Tripod.....	19
4.2 Sass Sampling Head Assembly and Mounting	20
4.3 Filter Canister Assembly and Installation.....	23
4.3.1 Multi Cell Denuder	23
4.3.2 Sharp Cut Cyclone (SCC)	26
4.3.3 Filter Media.....	29
4.4 Sample Configurations	29
4.5 Control Box Mounting	30
4.6 Ambient Temperature Sensor Mounting.....	31
4.7 Pump Box	31
4.7.1 Vacuum Hose Connections	32
4.7.2 Cable Connections	33
5. USER INTERFACE and MENU SYSTEM	34
5.1 User Interface – Touchscreen Display Functions.....	34
5.2 Menu Hierarchy and Navigation.....	34
5.2.1 Home Screen(s)	36

5.3	Menus	38
5.3.1	Operate Menu.....	38
5.3.2	Test Menu	41
5.3.3	Setup Menu Screen	42
5.3.4	About Menu Screen.....	46
6.	SASS/SuperSASS SYSTEMS	47
6.1	Basic Operations.....	47
6.2	SASS/SuperSASS Distinctions	47
6.2.1	SASS Details.....	47
6.2.2	SuperSASS Details	49
6.3	Flow System.....	51
7.	SASS/SuperSASS CONFIGURATION	52
7.1	System Setup	52
7.1.1	Clock Setup	52
7.1.2	Unit ID Setup.....	52
7.1.3	Password	52
7.2	Communication Configuration	53
7.2.1	Ethernet Setup	53
7.2.2	Notifications.....	54
8.	SASS/SuperSASS OPERATION	55
8.1	Event Manager	55
8.1.1	Add Sample Events.....	55
8.1.2	Modifying sample events	56
8.1.3	Importing sample events.....	57
8.1.4	Deleting Sample Events.....	57
8.2	Historical Events	58
8.2.1	Historical Events Navigation Guide	58
8.2.2	System ON/Off Options	60
8.2.3	Data Transfer	61
9.	MAINTENANCE and TROUBLESHOOTING	62
9.1	Recommended Periodic Maintenance Table	63
9.2	System Maintenance	63
9.2.1	System Inspection (during normal operations).....	64
9.2.2	System Cleaning	64
9.2.3	Denuder Replacement	64
9.3	System Test/Leak Check.....	65
9.3.1	System Leak Check Procedure	66

- 9.4 Calibration Procedures..... 67**
- 9.4.1 Temperature Calibration 67
- 9.4.2 Pressure Calibration 69
- 9.4.3 Flow Audit and Calibration 70
- 9.4.4 Flow Sensor Replacement 71
- 9.5 Clear Memory 71**
- 9.6 Basic Problem and Cause/Solution Table 72**
- 9.7 Additional Error Correction Instructions..... 73**
- 9.7.1 Link Down Error 73
- 10. DATA RETRIEVAL 74**
- 10.1 USB Memory Device..... 74
- 10.2 FSCommAQ Software 75
- 11. SPARE PARTS and ACCESSORIES 76**
- 11.1 Consumables, Replacement Parts, and Accessories 76

Table of Figures

Figure 1-1 SASS/SuperSASS	9
Figure 3-1 SASS Standard Accessories.....	16
Figure 3-2 SASS Tool Kit	16
Figure 4-1 SuperSASS System	18
Figure 4-2 Tripod Storage/Transport Configuration.....	19
Figure 4-3 Tripod Legs Deployed.....	19
Figure 4-4 Tripod Mounting Hole Pattern.....	20
Figure 4-5 Sampling Head.....	21
Figure 4-6 Sampling Head Screw Locations.....	21
Figure 4-7 Sharp-Cut Cyclone and Canister	22
Figure 4-8 SASS Canister Assembly Components.....	23
Figure 4-9 Sample Canister Assembly (PN 8370)	25
Figure 4-10 Sharp Cut Cyclone (8670).....	26
Figure 4-11 Sharp Cut Cyclone Disassembled	26
Figure 4-12 Sharp Cut Cyclone Parts Diagram	27
Figure 4-13 Penetration Curve, Sharp-Cut Cyclone (diam. 2.141mm)	28
Figure 4-14 Expected Configuration of SASS Canisters	29
Figure 4-15 Control Unit Mounting.....	30
Figure 4-16 Control Unit Mounting Detail	30
Figure 4-17 SuperSASS Vacuum Hose connections	32
Figure 4-18 Unattached Vacuum Hose	32
Figure 4-19 Vacuum Hose Attached	32
Figure 4-20 Vacuum Release Tab	33
Figure 4-21 Vacuum Hose Released	33
Figure 5-1 Main Screen For SASS/SuperSASS.....	36
Figure 5-2 Main Menu Drop-Down Selections.....	36
Figure 5-3 Setup Menu.....	37
Figure 5-4 Clock Setup Screen.....	37
Figure 5-5 Numeric Keypad	37
Figure 5-6 Alphanumeric Keypad.....	37

Figure 5-7 The Operate Menu 38

Figure 5-8 Stop Sample Screen 38

Figure 5-9 Event Manager..... 38

Figure 5-10 Transfer Data Screen..... 39

Figure 5-11 Historical Events Main Screen..... 39

Figure 5-12 Upgrade Software Screen..... 39

Figure 5-13 Restart System Screen 40

Figure 5-14 Shut Down System Screen 40

Figure 5-15 Test Menu..... 41

Figure 5-16 System Test Screen (SASS) 41

Figure 5-17 Temperature Calibration Screen 41

Figure 5-18 Pressure Sensor Calibration Screen 42

Figure 5-19 Clow Calibrate Screen 42

Figure 5-20 Test Menu..... 42

Figure 5-21 Event Defaults Screen 43

Figure 5-22 Clear Memory Screen..... 43

Figure 5-23 Flow Sensor Screen..... 43

Figure 5-24 Notification Configuration Screen 44

Figure 5-25 Logging Screen 44

Figure 5-26 Setup Display..... 44

Figure 5-27 Clock Screen..... 45

Figure 5-28 Unit ID Screen 45

Figure 5-29 Password Screen 45

Figure 5-30 Ethernet Configuration Screen 46

Figure 5-31 Remote Access Config Screen 46

Figure 5-32 About Menu Screen 46

Figure 6-1 SASSFlow Diagram..... 48

Figure 6-2 SuperSASS Flow Diagram..... 50

Figure 7-1 Ethernet/IP Config..... 53

Figure 7-2 Ethernet Config Auto/Static Dropdown 53

Figure 7-3 DNS Config Screen 53

Figure 7-4 Notification Configuration Screen..... 54

Figure 7-5 Notification Recipients Screen..... 54

Figure 7-6 Notification Type Screen 54

Figure 8-1 Event Add Screen 55

Figure 8-2 Event Start Time Screen 55

Figure 8-3 Sample Duration Screen 55

Figure 8-4 Canister Set Dropdown 56

Figure 8-5 Event Add Canister ID Screen 56

Figure 8-6 Saved Event 56

Figure 8-7 Historical Events Main 58

Figure 8-8 Volume Summary 59

Figure 8-9 Min/Max (1)..... 59

Figure 8-10 Min/Max (2) 59

Figure 8-11 Max Delta-T..... 59

Figure 8-12 Warnings 59

Figure 8-13 Power Interruption 59

Figure 8-14 Real Time Values 59

Figure 8-15 5-Minute Averages 59

Figure 8-16 Restart Screen..... 60

Figure 8-17 Shutdown Screen 60

Figure 8-18 Copy to USB Screen..... 61

Figure 9-1 System Test Leak 66

Figure 9-2 Temperature Calibrate Screen with Selection Choices 67

Figure 9-3 3 Point Temp Calibration Screen..... 68

Figure 9-4 Pressure Calibrate Screen..... 69

Figure 9-5 Flow Calibrate Screen 70

Figure 9-6 Clear Memory Screen..... 71

Figure 9-7 Link Down Screen 73

Figure 10-1 Copy to USB Storage Device 74

Table of Tables

Table 1-1 Specifications.....	11
Table 4-1 Denuder Performance Test Results	24
Table 5-1 SASS/SuperSASS Menu Hierarchy.....	34
Table 5-2 Main Display Parameter Descriptions	36
Table 9-1 Recommended Maintenance Schedule for the SASS/SuperSASS Sampler.....	63

1. INTRODUCTION

1.1 *About This Manual*

This manual presents assembly and operational procedures for the SASS (Speciation Air Sampling System) and the SuperSASS (second-generation upgrade). Both the SASS and the SuperSASS are trademarks of Met One Instruments. The SuperSASS includes all the operating benefits of the SASS but with expanded sampling canister stations and additional sequential programming in groups of sample collection canisters. The term SASS will be used in this manual to identify basic concepts used for both the SASS and the SuperSASS. The term SuperSASS will be used to identify features or details specific to the SuperSASS.

1.2 *Technical Service*

Should support still be required after consulting the printed documentation, contact one of Met One Instruments, Inc.'s expert Technical Service representatives during regular business hours of 7:00 a.m. to 4:00 p.m. Pacific Standard Time, Monday through Friday. In addition, technical information and service bulletins are found on our website. Please contact us and obtain a Return Authorization (RA) number before returning any equipment to the factory. This allows us to track and schedule service work and expedite customer service.

Contact	Tel: + 541 471 7111	Address:	Met One Instruments, Inc.
Information:	Fax: + 541 471 7115		1600 Washington Blvd
	Web: http://www.metone.com		Grants Pass, Oregon
	Email: service@metone.com		97526 U.S.A.

Please have the instrument serial number available when contacting the manufacturer. Serial numbers on most models manufactured by Met One Instruments are located on a silver product label on the unit and printed on the calibration certificate. The serial number will begin with a letter followed by a unique five-digit number, such as U15915.

1.3 SASS/SuperSASS_{2.5} Ambient Chemical Speciation Sampler



Figure 1-1 SASS/SuperSASS

*Sampling head, tripod, control box, ambient temp sensor and vacuum pump box.

1.3.1 SASS/SuperSASS Overview

The SASS (Speciation Air Sampler System) chemical sampler was developed under contract from the United States Environmental Protection Agency – US-EPA by Met One Instruments. The SASS collects samples for the chemical and gravimetric analysis of ambient air PM_{2.5} particles. PM_{2.5} refers to those airborne particles with diameters smaller than 2.5 μm. These particles are comprised of sulfates, nitrates, organic carbon, soot-like carbon, and metals. With the recently enacted fine particle standard for PM_{2.5}, the US-EPA has mandated a new sampling network for determining the concentration of each species. The SASS has been specifically designed to meet these needs.

The measurement techniques for the different chemical constituents, including semi volatile components such as nitrates, have been developed through special sampling programs 1-3. These studies have shown that other sampling techniques are required for analyzing the different chemical constituents of PM_{2.5}. Met One Instruments, Inc. has worked closely with the US-EPA and potential end users to develop the SASS and the SuperSASS to comply with government regulations and incorporate features that the end user will likely find desirable. These features include portability, and a design, which allows the collection of samples without the user having to handle either the sample filter or the denuder.

1.4 SASS/SuperSASS Specifications

Table 1-1 Specifications

PARAMETER	SPECIFICATION
Analytes:	PM _{2.5} : Mass and trace metals, organic and elemental carbon, sulfate, nitrate, other ions, and elements
Number of Canisters:	SASS=Five (5), SuperSASS=Eight (8) maximum
Sample Flow Rate:	6.7 Liters/minute +0.1 to -0.2 LPM per canister, active flow-controlled channels. (SASS and SuperSASS) 7 Liters/minute per canister, critical orifice channels. (SASS only)
Flow Accuracy:	+0.1 to -0.2 LPM or L/min (Liters Per Minute)
Inlet:	Sharp Cut Cyclone (SCC), (D50 2.5 µm AED) Detachable from canister
Denuders:	Multicell, magnesium oxide, sodium carbonate, citric
Filter Type:	47mm PTFE disc filters standard. Other filter material types available
Filter Holder:	Accommodates standard EPA-pattern white Delrin filter cassettes
Filter Per Canister:	One or two in series
Ambient Temperature:	(-30 to 50°C) Bead thermistor in naturally aspirated radiation shield
Filter Temperature:	(-30 to 50°C) bead thermocouple at inlet for canister 1 (SASS) (-30 to 50°C) bead thermocouple at inlet of each canister (SuperSASS)
Logged Parameters:	Ambient Temp., °C (-30 to 50) Filter Temp. °C (-30 to 50) Sample start date and time Sample stop date and time Status of Sampler, Flags Volumetric flow rates (L/m) Volume (m ³ /hr)
Logging Interval:	5 minute averaging
Sample Events:	24-hour samples standard. Programmable start date/time and duration
Support Stand:	Tripod with platform-mounting feet and mast
Solar Radiation:	Shield, 20" (50.8 cm) diameter. X 12" (30.48 cm) H, Naturally Aspirated
Control Box:	Weatherproof enclosure Width:10" (25.4 cm), height:11.11" (28.2 cm), depth: 6.25" (15.6 cm)
Pump Power:	Standard: 120VAC Optional: 220VAC (upon request)
Power Supply:	Input: 100 VAC to 240 VAC, .5 AMPS Typical Output: 12 V, 5.8 A, AC/DC Switching

System Max Power Consumption:	120VAC, 60 HZ, 3.85 AMPS 220VAC 50HZ, 3.15 AMPS
Data Collection:	USB data port Ethernet
Memory Capacity:	32 Gigabytes
User Interface:	4.75" (11.2 cm) x 6.75" (17.1 cm) graphic touchscreen
Deployed Dimensions:	Width: 14.4" (37 cm), height: 77" (2.0 m), depth: 14" (36 cm)
Footprint Dimensions	Width: 23.5" (59.69 cm), depth: 24.5" (62.23 cm)
Weight:	Sampler: 45lb (20.4 kg) (without inlet head), Tripod: 10.5lb (4.8 kg)

* The approximate upper concentration limit is based on the sampler's ability to maintain 16.67 L/min sample flow over the entire 24-hour period, despite PTFE filter loading with typical urban PM_{2.5} particulate. Actual concentration limits will vary depending on ambient conditions, altitude, and particulate type.

Specifications may be subject to change without notice.

2. SITE SELECTION and POSITIONING CRITERIA

Met One Instruments, Inc. recommends checking local regulations and guidance documentation before selecting the site to install the SASS/SuperSASS. For example, US-EPA provides a variety of guidance documents where site selection issues are addressed. Such guidance and regulation may provide information concerning:

- Inlet height.
- Spacing and clearance.
- Proximity to particulate sources, both mobile and stationary.
- Additional siting criteria or considerations.

These details should be understood before selecting a site.

3. SETUP

Use the following information to correctly assemble, configure, and deploy the SASS/SuperSASS PM_{2.5}. Installation of the SASS/SuperSASS PM_{2.5} should be performed by personnel familiar with environmental monitoring equipment. There are no special precautions or handling concerns except for the standard level of care required for handling scientific equipment. Refer to the instructions and diagrams on the following pages.

3.1 Unpacking The SASS

NOTE: Please keep all the special shipping items (box, foam packing material, etc.) used to ship the SASS/SuperSASS PM_{2.5}. They should be re-used if the SASS/SuperSASS PM_{2.5} is to be transported (changing site locations, returning to the factory, etc.). Contact Met One Instruments for replacement packing materials if necessary.

3.1.1 Shipping Damage

Any damage incurred to the equipment during shipping is the responsibility of the carrier. If any damage to the shipment is noticed before unpacking, **a claim must be filed with the commercial carrier immediately**. Follow any special unpacking instructions provided by the carrier as all items are carefully removed from the containers and each component inspected. It is recommended to document and photograph all damaged packages and items before, during, and after unpacking them. Contact Met One Instruments to arrange for any replacement items needed.

- Carefully unpack items from the box.
- Inspect all components for damage.
- Compare all components to the packing list to ensure all items have been shipped.
- After unpacking all components/sub-assemblies, take a photo of each with labels still attached and check to make sure they match all components/sub-assemblies listed on the packing list.

From the list provided below, check that all mandatory, standard equipment has been included (indicated by serial number):

3.1.2 Shipment Contents

The normal instrument configuration is supplied with the following standard accessories listed below.

SASS/Super SASS System Check-Off List

- One operating manual
- One control box (**83375**)
- One sampling head: (**8861-1**) SASS; SuperSASS (**8861-2**)
- One tripod assembly (**8864**)
- One pump box with power supply: (**8862-1**) SASS; (**8862-2**) SuperSASS
- One temperature sensor (**065**)
- One radiation shield (**074**)
- One canister assembly block (**8421**)
- Speciation sample canisters (**8370**): SASS (5); SuperSASS (8)
- Sharp-cut cyclones (**8670**): SASS (5); SuperSASS (8)
- MgO-coated denuder (**8382**): SASS (1); SuperSASS (2)
- One cassette transport case (**8460**)
- One tool kit (**8629**)

The standard components for the SASS/SuperSASS are shown in **Figure 3-1 SASS Standard Accessories**

Optional Accessories

The following optional accessories may be purchased separately:

- MgO coated denuder (**8382**)
- 47mm 2-micron pore-size Teflon filters (**460138**)
- 47mm glass fiber filters (**460138**)
- 47mm 1-micron pore-size nylon filters (**460141**)



Figure 3-1 SASS Standard Accessories



Figure 3-2 SASS Tool Kit

3.2 Electrical Service

The sample site needs to be equipped with AC power and a standard weatherproof outdoor electrical outlet. Power Designations are specified at the time of purchase. To provide electrical hazard protection, a heavy green/yellow ground cable is attached to the bottom of the pump box. This ground cable provides an electrical hazard ground, and static discharge path. It also provides some protection for the equipment from induced electrical currents that may occur during nearby lightning strikes. If a ground rod is not available, a cold-water pipe can be used as an alternative. If a water pipe must be used, be sure that a suitable type of compression grounding clamp is attached to the water pipe.

NOTE: If a water pipe is used as a ground, be sure that it is a cold-water pipe, and not a gas pipe, or hot water pipe. They do not provide a suitable ground or have the potential for explosion.

In addition, it is recommended that one leg of the mounting tripod also be grounded to the same earth ground used to ground the pump box. For maximum effectiveness, a copper cable of AWG # 6 or larger should be used to ground the tripod.

The sampler should be equipped with a backup uninterruptible power supply (UPS) during applications where sample invalidations due to power failures are unacceptable. The supplied power must be rated for the electrical load and appropriately configured for an outdoor application. Consult a qualified electrical contractor. See **Table 1-1** Specifications for electrical specifications.

4. ASSEMBLY and DEPLOYMENT

The SASS/SuperSASS design allows for easy setup and deployment for long or short-term sampling applications. The following sections in Chapter 4, "ASSEMBLY and DEPLOYMENT," explain setup procedures and proper system configuration for the SASS and SuperSASS.



Figure 4-1 SuperSASS System

Aspirated solar radiation shield, canister inlets, tripod, control box, and vacuum pump box.

4.1 Tripod Assembly

The Met One EX-905 aluminum tripod is a standard accessory and recommended mounting option for the ES-808 in most outdoor applications. To deploy the tripod, follow the instructions below.

4.1.1 Tripod Leg Deployment

The EX-905 is shipped in the storage/transport configuration shown in **Figure 4-2**. In this configuration the tripod mast is upside down. To deploy and secure the tripod, follow the steps below.

1. Withdraw the three stainless steel detent pins from the tripod mast base by pulling the rings attached to the three pins.
2. Flip the tripod so the mast is pointing up, this will allow the leg brackets to pivot down into the mast base slots.
3. Line up the hole in the leg bracket with the detent pin holes in the mast base slot.
4. Insert each pin until the detent ball is visible from the other side securing the legs in the open position. Make sure the assembled tripod is rigid and stable.

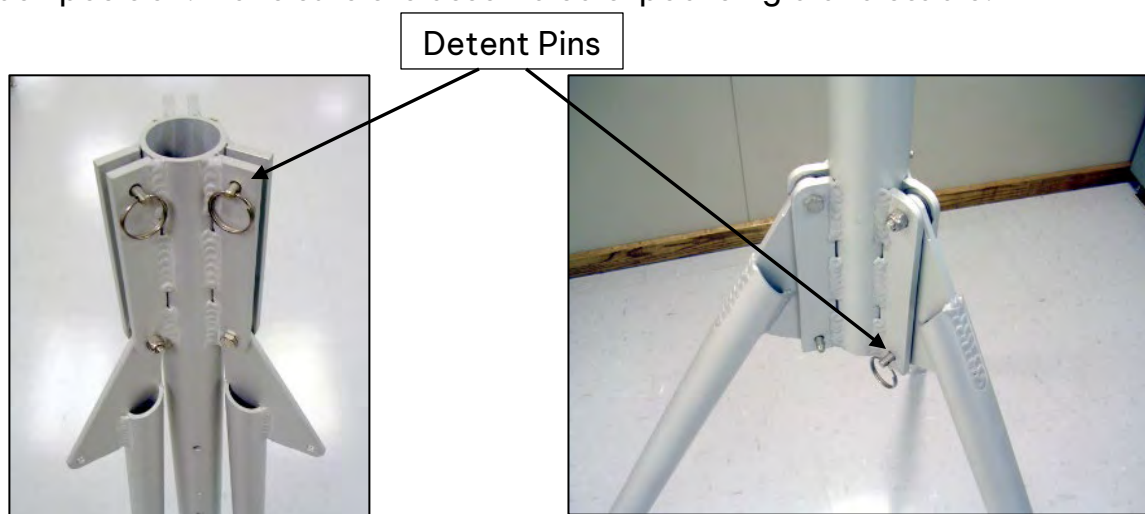

Figure 4-2 Tripod Storage/Transport Configuration

Figure 4-3 Tripod Legs Deployed

4.1.2 Securing the EX-905 Tripod

Holes are provided in the tripod feet. Commercial hardware can be used to anchor the tripod to the sampling site. Typically, AMS and SLAMS operating sites consist of wooden constructs. Use of 1/4" lag screw mounting is advised to attach tripod feet to the sampling platform. If the sampling site is on the ground, drive spikes through the tripod mounting feet. If cement or other hard material is present on the sampling site surface, commercial hardware must be used to properly secure the tripod.

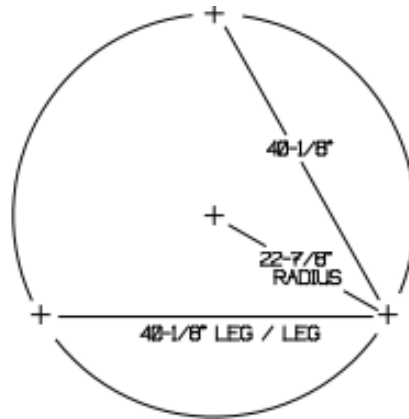

Figure 4-4 Tripod Mounting Hole Pattern

CAUTION: The tripod and sampling system operate at approximately 72 inches above ground or sampling deck level. Anchor the tripod using commercial hardware to the sampling deck to prevent damage during high winds or extreme weather. Installation instructions are provided on the outside of each tripod shipping carton.

4.2 *Sass Sampling Head Assembly and Mounting*

WARNING: When installing the sampling head, use a step ladder and/or have a second person aid in the process. The bottom shield must be set in place before any socket head cap screws can be installed.

Remove the Sass sampling head from the shipping materials. The sampling head assembly shown in (Figure 4-5) consists of:

- Upper shield with canister mounting plate, bundle of black tubing and a gray cable.
- Sheet metal bottom shield with eight holes near the outer area, one larger hole with hub in the middle and a small, tethered detent pin inserted into the hub.

With the head assembly upside down, (see Figure 4-5) lift off the bottom shield, allowing the hoses and cable to slide out of the hub at the center of the bottom shield. Pull the pin from the hub allowing it to hang by the chain. With the bottom shield separated from the upper shield, tubing, and cable, slide the shield over the top of the tripod mast with the hub facing down. The shield will rest on the leg weldment. Remove the gray PVC shipping tube from the center of the sampling head assembly by sliding it over the tubing and wire. This tube is used to align sections during shipment and is not required for assembly.



Figure 4-5 Sampling Head
(Upside-down position)

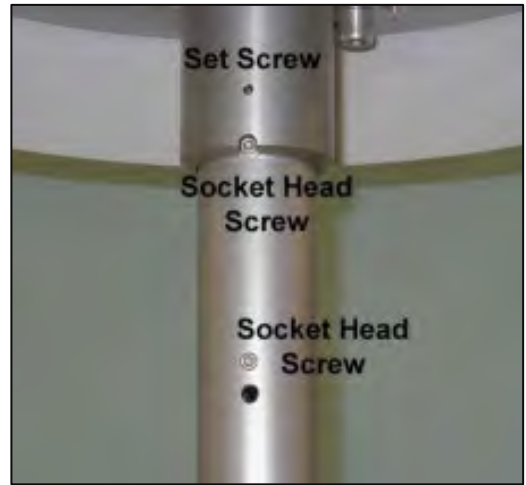

Figure 4-6 Sampling Head Screw Locations

Next, install socket head screws (**Figure 4-6**). Locate the tool kit and plastic bag. Each bag contains three 8-32 x 3/16"-long socket head cap screws. An extra screw is provided. Screws have been treated with thread-locking compound. Use the 3/16" T-handle Allen wrench provided to install the screws into the two tapped holes in the top area of the tripod mast. These screws provide upper and lower shield orientation.

Uncoil the gray cable with connector and tubing bundle originating from upper sampling head hub. While supporting the sampling head, feed the bundle into the opening at top of the mast and mount the hub onto the mast. For proper alignment, engage notch in hub with the topmost screw head. Tighten the two factory-installed setscrews located in the sampling head hub to secure sampling head to mast. A bundle of black sample hoses and one electrical cable should be protruding from tripod mast base.



Figure 4-7 Sharp-Cut Cyclone and Canister
Provides PM cut point, inverted canister within canister assembly block.

4.3 Filter Canister Assembly and Installation

The integrated sampler canister (**Figure 4-8**) contains the following components:

1. Sharp Cut Cyclone Inlet.
2. Denuder to remove nitric acid, other interfering gases.
3. Empty denuder ring.
4. 47mm front filter cassette for particle capture.
5. 47mm tandem or backup filter cassette as needed.
6. Filter cassette holder (Up to two filter cassettes).
7. Sampler canister main body.
8. Sample canister hardware.

NOTE: An empty denuder ring is used when no denuder is needed. Assembly details are indicated in Figure 4-9.



Figure 4-8 SASS Canister Assembly Components

4.3.1 Multi Cell Denuder

Denuders consist of tubes/annular spaces that capture reactive gases while allowing particles to penetrate. Gases possess a large diffusion coefficient, and their random motion brings them into contact with denuder walls. With appropriate coatings/selection of denuder material, semi volatile vapors are captured within the denuder walls. In contrast, particles follow airflow streamlines and pass through the denuder without contacting the walls. The particles penetrate the denuder and are captured by a filter placed downstream of the denuder. The filter medium is selected to adsorb vapor from subsequent volatilization of collected particles.

The SASS nitric acid denuder is a hexagonal, aluminum cell coated with magnesium oxide. There are approximately 350 hexagonal channels with each channel approximately

1.6mm in diameter. The denuder is 25 mm long. Initial testing with filtered air confirms that no shedding of MgO particles from the denuder is likely to occur. Tests also confirm 100% penetration of both liquid and solid particles in the size range tested. Nitric acid collection efficiency of the SASS denuder was measured in the laboratory using a permeation tube source diluted with purified (ammonia-free) laboratory air and a catalyst- equipped chemiluminescent nitrogen oxide analyzer detector. Measured nitric acid efficiency at the design flow rate of 6 L/min is 95%. Denuder performance test results are summarized in **Table 4-1 Denuder Performance Test Results**

Table 4-1 Denuder Performance Test Results

DENUDER	PARAMETER TESTED	TEST	RESULT
Multicell Aluminum. coated with MgO Length: 25 mm # of channels:~350	Liquid particle penetration	Penetration of oleic acid particles with diameters in the range from 0.5 μm	100% penetration for all particle sizes tested
	Solid particle penetration	Penetration of solid particles with diameters in the range from 0.5 μm to 1.5 μm	100% penetration for all particle sizes tested
	Collection efficiency for nitric acid	Measure the penetration of nitric acid through the denuder at concentrations of 50 ppb and 100 ppb	95-99% collection efficiency

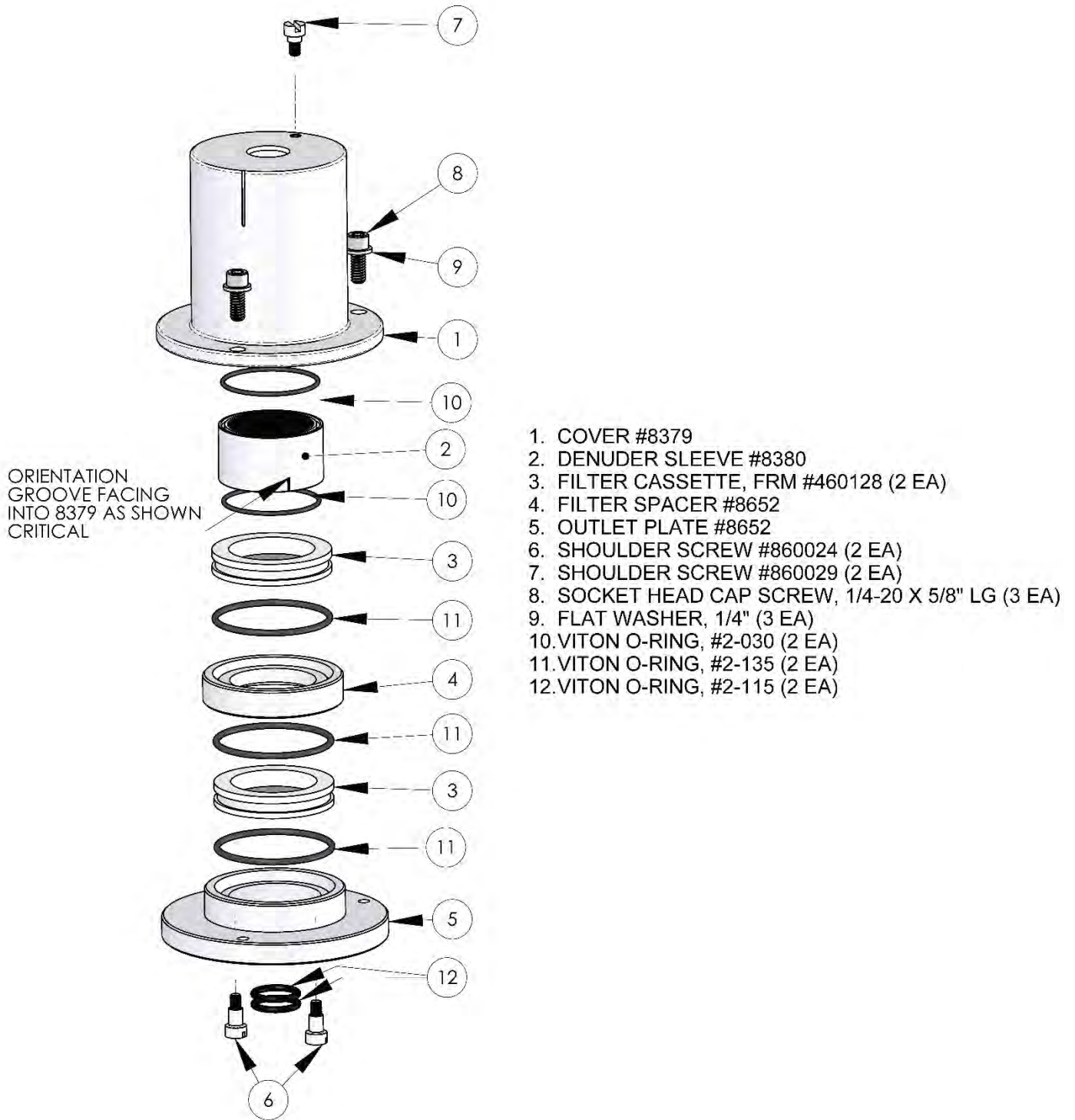

Figure 4-9 Sample Canister Assembly (PN 8370)

4.3.2 Sharp Cut Cyclone (SCC)

The SASS inlet selectively transmits airborne particles according to PM_{2.5} criteria. After exiting the inlet tube, aerosol moves cyclonically within the body of the cyclone where larger particles are transported, due to inertia, against the outer wall. The unique design of this computer-modeled cyclone (**Figure 4-10**) produces the desired sampling efficiency. Curvatures of the cyclone body cause particles to inertially move towards the outside wall and migrate into the collection/grit cup to be disposed. Drift velocity is minimal compared to the velocity along the channel. Deposition of particles is relatively gentle and at a tangential angle, accounting for observed lack of particle bounce even without greased surfaces. The grit cup should be cleaned periodically. The penetration curve of the Sharp-Cut Cyclone is evaluated within

Figure 4-13.



Figure 4-10 Sharp Cut Cyclone (8670)



Figure 4-11 Sharp Cut Cyclone Disassembled

- 1- Grit Pot #8664
- 2- Body #8662
- 3- Outlet Head #8666
- 4- Bracket #8665
- 5- Viton O-Ring, #2-016
- 6- Viton O-Ring, #2-020
- 7- Viton O-Ring, #2-015 (2 each)
- 8- Flat Washer, #4 (3 each)
- 9- Socket Head Cap Screw, #4-40 X 1" lg.
- 10- Socket Head Cap Screw, #4-40 X 1 1/4" lg. (2 each)

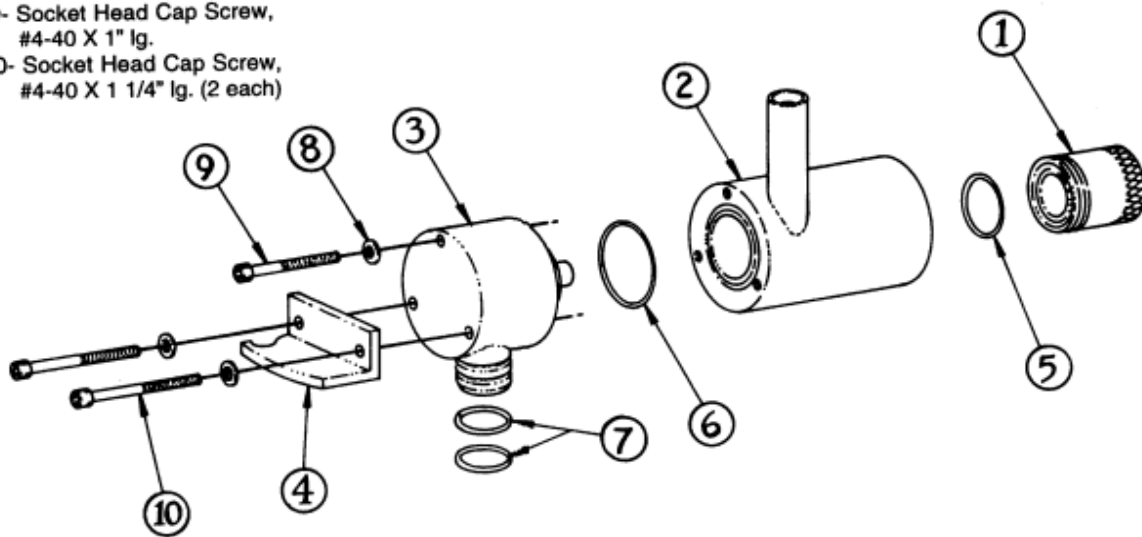

Figure 4-12 Sharp Cut Cyclone Parts Diagram

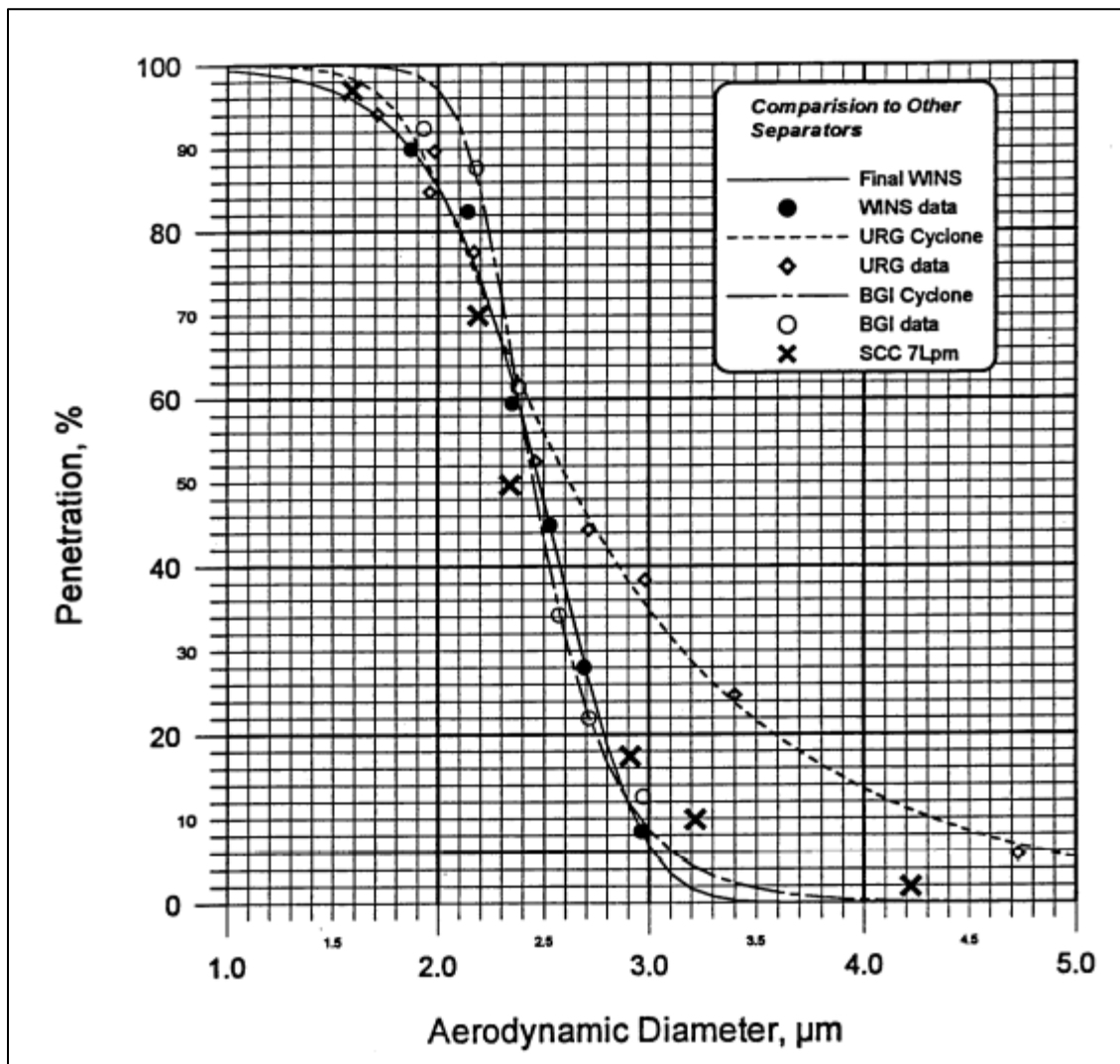

Figure 4-13 Penetration Curve, Sharp-Cut Cyclone (diam. 2.141mm)

4.3.3 Filter Media

Several types of filter media are necessary for assaying chemical constituents of ambient particles. The filter media must be suitable for the type of analysis to be performed. For example, Teflon™ filters are used for gravimetric mass and trace metal determinations. Quartz filters are used for analysis of total organic carbon since, unlike other filter media, quartz filters contain trace amounts of carbon. See **Section 11.1** for available filter media options offered by Met One Instruments.

4.4 Sample Configurations

Canisters can be configured with one or two filters, a denuder and one filter, or a denuder and two filters. Types of denuder and filter media can be tailored to specific needs and desires of the sampling program. In this way, it can accommodate new denuder filter methods as they are established.

The SASS can be used for organic sampling in any configuration (**Figure 4-14**). All include an MgO-coated aluminum denuder, two Teflon™ filters, one for mass and metals analysis, and one for inorganic ion analysis. The third leg is a MgO-denuded nylon filter provided for fine-particle nitrate measurement, and the fourth leg is double quartz for organic and elemental carbon analysis. For EPA testing, canisters are configured with Canister #1 containing a Teflon™ filter, Canister #2 containing MgO denuder and a nylon filter, and Canister #3 containing a quartz filter. Multiple options exist regarding various particulate types, vapors, and volatile/semi volatile compounds. Users should consult the applicable reporting agency for instruction related to correct filter and denuder media use for sampling and reporting requirements.

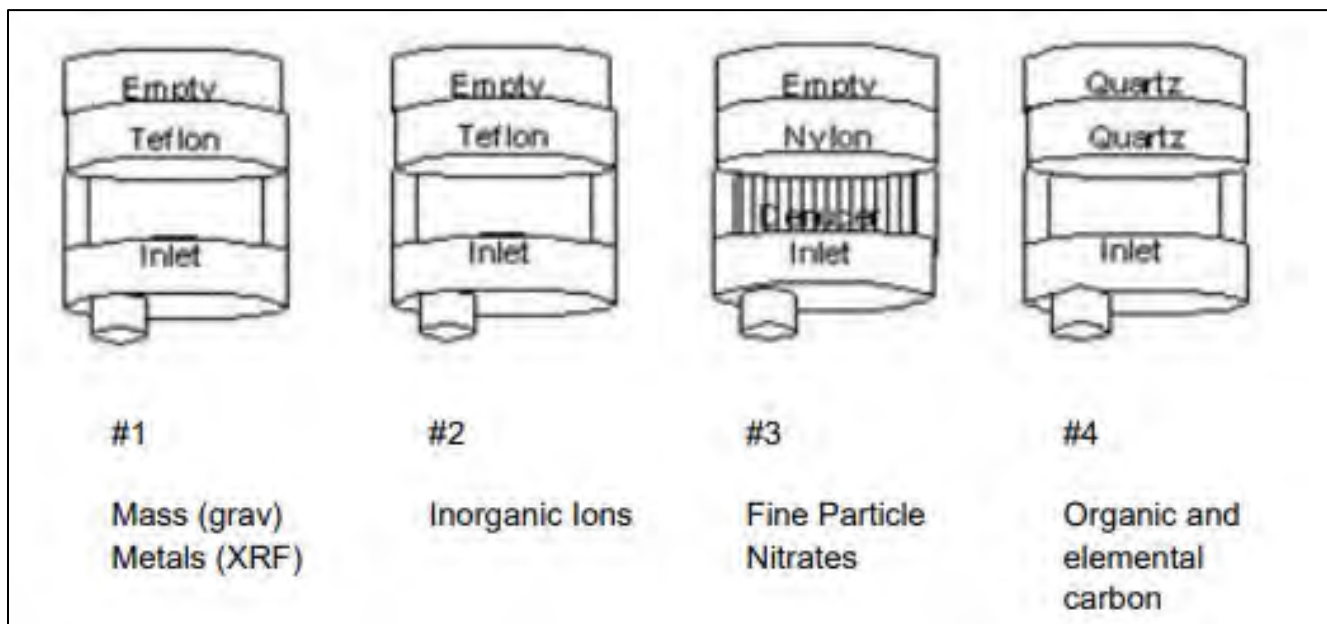

Figure 4-14 Expected Configuration of SASS Canisters

Use of MgO denuder for removal of gaseous nitrates.

4.5 Control Box Mounting

The SASS control unit is a weather resistant, environmentally sound enclosure. The control unit houses a microprocessor, touch-screen display, USB port, Ethernet port, and power connection. The SASS control unit is designed for angle mounting on the tripod for ease of operation and readability. Included with the control unit are two metal mounting brackets and two sets of U-bolt hardware clamps. Use the supplied wrench or a 7/16” nut driver to secure the mounting hardware. **Figure 4-16** shows the proper mounting configuration.



Figure 4-15 Control Unit Mounting



Figure 4-16 Control Unit Mounting Detail

A set of mounting brackets holds the control unit to the mast above the tripod legs. Using the two U-bolts supplied in the hardware package, secure control unit to the mast. Make sure to properly position control box with the hinged side of the box facing the left (from the front). All cable connections should be facing down. Once the unit is properly positioned, tighten the U-bolt hardware clamps using the supplied wrench or a 7/16” nut driver.

4.6 Ambient Temperature Sensor Mounting

The SASS includes a passive ambient temperature sensor using a thermistor protected by several round plates. The shield is naturally aspirated, allowing for an accurate temperature measurement. The ambient sensor assembly includes a Model 074 temperature shield, Model 065 temperature sensor, tripod mounting hardware, and cable with connectors.

After the control unit is secured to the tripod, mount the ambient temperature sensor and shield assembly. Attach the shield and temperature sensor assembly using one U-bolt and two 7/16" nuts with washers. The temperature shield should be mounted above the lower mounting bracket of the control unit (see **Figure 4-16** Control Unit Mounting Detail). Place the ambient temperature sensor on the mast with the flat top plate facing up and the cable connector facing the ground. Lower the sensor until the mounting bracket is about two inches from the top of the control unit's bottom bracket. Position the ambient temperature sensor so that the shields face the back of the tripod. When positioned, secure the sensor by tightening two 7/16" hardware nuts and washers using the supplied wrench or a nut driver.

Typically, the temperature sensor assembly should be positioned approximately three inches above the lower control unit U-bolt. The top of the shield should be at approximately the same level as the top of the control unit box. This will allow the lower shield of the sampling head to be lowered without hitting the top of the temperature shield (see **Figure 4-15** and **Figure 4-16**). See **Section 4.6** to attach the cable and connector to the ambient temperature sensor from the pump control box. The connector and plug are keyed to reduce the possibility of an improper connection. If the connector does not seat easily, check the connector pins and key alignment, do not force it on.

4.7 Pump Box

The dual-diaphragm AC vacuum pump is contained in a weatherproof pump box. This pump box is isolated from the sample head to prevent vibration, noise, heat, or any potential exhaust contamination. The vacuum pump is a dual-headed Thomas Co.TM diaphragm vacuum pump mounted with four bolts through the bottom of the pump box chassis. The vacuum pump box contains a filter screen under the pump and an aspiration fan on the side. Heat is exhausted from the box by pulling ambient air into the base through the fan and exhausting it through the side. The pump box is mounted on an aluminum framework stand or chassis with four 1/4" anchoring holes provided in the base. The pump should be located close to the base of the tripod on the floor or deck of the sampling platform. Pre-drilled holes are used for securing the pump box to the platform. The base can be mounted using 1/4" bolts or lag screws. The holes are located on a hole pattern of 10" x 16" dimensions.

4.7.1 Vacuum Hose Connections

Locate and identify sample hoses hanging from the base of the tripod mast. The SASS will have five hoses, the SuperSASS will have Eight hoses. All hoses are labeled with a number located half an inch from the male quick connector. Match the hose number to the female fitting number located just above the fitting. Hose number one should be matched with fitting number one on the pump, and so on. All hoses should be connected for proper operation.

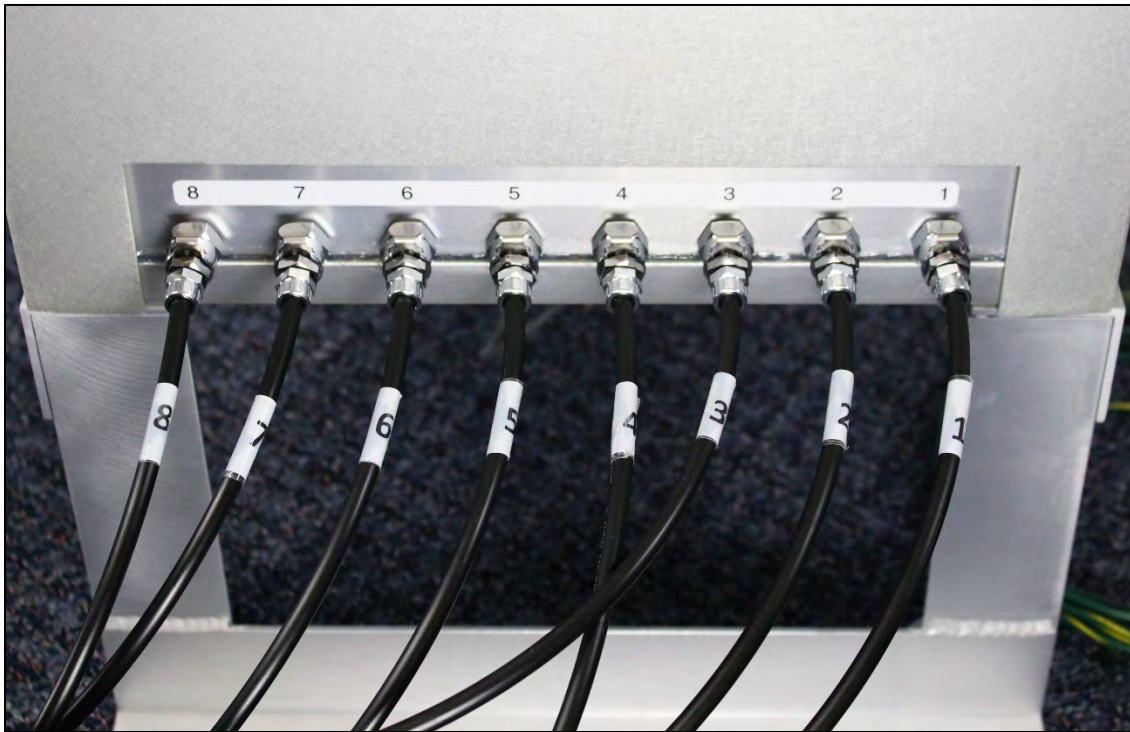

Figure 4-17 SuperSASS Vacuum Hose connections

To connect the hose, push the male quick connector into the female fitting on the pump. When the release tab of the female fitting pops up, the connector is fully seated and airtight.



Figure 4-18 Unattached Vacuum Hose



Figure 4-19 Vacuum Hose Attached

To disconnect a hose from the pump box, simply push down on the release tab of the female adaptor with your thumb and pull the connector away from the pump box.



Figure 4-20 Vacuum Release Tab



Figure 4-21 Vacuum Hose Released

4.7.2 Cable Connections

The pump box contains three cables that are fed from the bottom of the pump box:

- A three-pronged power cable.
- A signal cable with a screw-type, 6-pin connector that attaches to the ambient temperature sensor.
- A second cable with a screw-type, seven-pin connector that attaches to the connector on the bottom of the control box labeled “Pump Box”.

The screw-type connectors are keyed to ensure correct pin alignment. To secure the screw-type connectors to the mating or receiving connector, align the key to the slot, allowing the connectors to mate. Apply light pressure by pushing the connector inwards and rotate the outer lock ring on the front of the connector clockwise to lock it into place. Gently wiggle the connector to confirm that the plug is locked in place. The connector should not move excessively and/or come unplugged if wiggled or gently tugged on.

The grey cable with a screw type connector, bundled with the sample tubing, will need to be connected to the pump box. The connection point on the pump box is located to the left of the exhaust rain hood.

With all cables connected, black zip-tie wraps can be used to secure cables to a tripod leg. Natural or nylon tie wraps will break down in direct sunlight and will be prone to breakage. The SASS includes five sample channels, and the SuperSASS includes eight potential sample channels.

5. USER INTERFACE and MENU SYSTEM

This section describes the SASS/SuperSASS user interface system, and describes the functions of the main menu options, including how to view data and errors.

5.1 User Interface – Touchscreen Display Functions

The SASS/SuperSASS user interface is a touchscreen display It is mounted inside the control box enclosure and is only accessible when the door of the SASS control box is open.

5.2 Menu Hierarchy and Navigation

The SASS/SuperSASS menu structure is outlined in the following table.

Table 5-1 SASS/SuperSASS Menu Hierarchy

Menu	Sub Menu Options	Overview
OPERATE	Stop Sample	Cancel the current sampling event (visible during sample events)
	Event Manager	Configure upcoming sample events
	Transfer Data	Download stored data to a USB memory stick
	Historical Events	View: Min/Max ambient values, Warnings, Power interruptions, Real time values, 5-minute averages, Event summary.
	Update Software	Upgrade system software with USB storage device
	Restart System	Restart system if any major changes are made
	Shutdown System	Power down the system for storage or transport

Menu	Sub Menu Options	Overview
TEST	Temp Calibrate	Calibrate temperature sensors or restore default settings
	Pres Calibrate	Calibrate pressure sensors or restore default settings
	Flow Calibrate	Calibrate flow rate or restore default settings
	System Test	Check function of flow system, turn pump on/off, leak test
	Temperature Calibrate	Calibrate ambient and filter temperature sensors
	Pressure Calibrate	Calibrate ambient barometric pressure sensor
	Flow Calibrate	Calibrate flow sensors
SETUP	Event Defaults	Set the default values for the Event Manager
	Clear Memory	Clear all stored data and alarm logs
	Set Clock	Set the date and time
	Unit ID	Set or change the numerical ID of the sampler
	Password	Change or disable the master password
	Serial Port	Set the baud rates for serial communications
	Sound Volume	Adjust the volume of the touchscreen sounds
	Touch Calibrate	Calibrate the touch screen
ABOUT	No sub menu	Details the current firmware type and version number, control box serial number, and display version.

Menu selections and instructions are detailed in the following sections of this operating manual as assigned in the Main Menu column of **Table 5-1** above.

5.2.1 Home Screen(s)

The Home or main operating screen is designed to provide the current status of the sampler and any programmed events. **Figure 5-1** Main Screen For SASS/SuperSASS illustrates the home screens for the SASS and SuperSASS. The up and down arrow keys are used to navigate between the various screens showing current data.

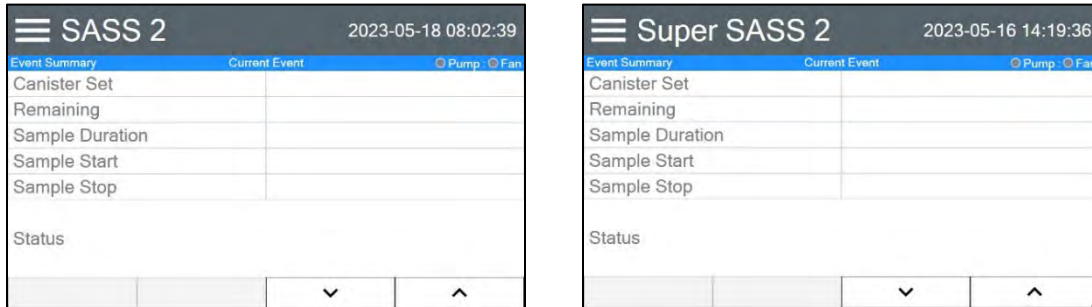



Figure 5-1 Main Screen For SASS/SuperSASS

***Table 5-2** describes the real-time fields displayed on the Home screen:

Table 5-2 Main Display Parameter Descriptions

Parameter	Description
Canister Set	Designated ID of the filter cassette for the sample event
Remaining	Remaining time of the current sampling event.
Sample Duration	The preset time of the current sample
Sample Start	The start time of the sample in the following format: YYYY-MM-DD HH:MM:SS
Sample Stop	The stop time of the sample in the following format: YYYY-MM-DD HH:MM:SS
Status	Current operation such as sampling, waiting, stopped, etc.

See **Section 8.1** for more details about programming sample events.

To access the various menus, press the three horizontal lines  in the top left corner. A drop-down menu will appear (**Figure 5-2**) to allow selection of any of the four main menus. This option is available on all main menu screens.

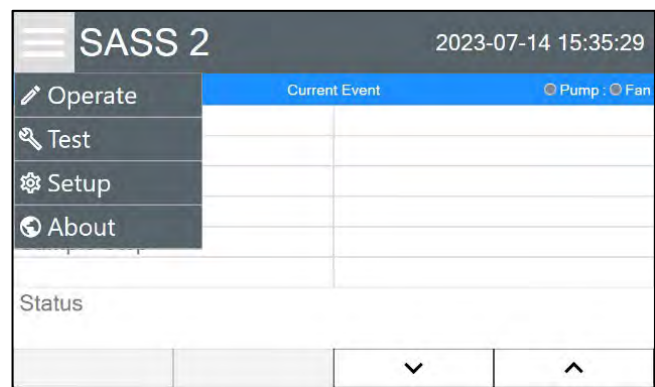

Figure 5-2 Main Menu Drop-Down Selections

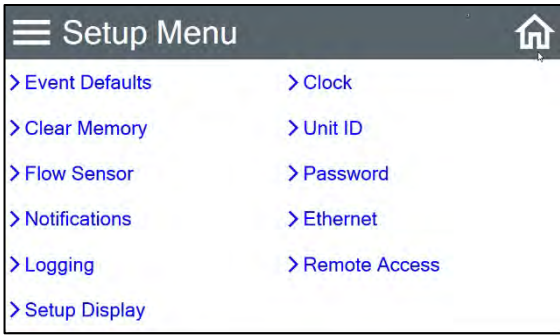



Figure 5-3 Setup Menu

To return to the Home screen, press the Home icon  located in the upper right corner of all main menu screens. This icon can clearly be seen in the Setup Menu image shown in **Figure 5-3**.

To cancel an action and return to the previous menu screen, press the X icon  located in the upper right corner of all sub menu screens. This icon can clearly be seen in the Clock Setup screen image shown in **Figure 5-4**.

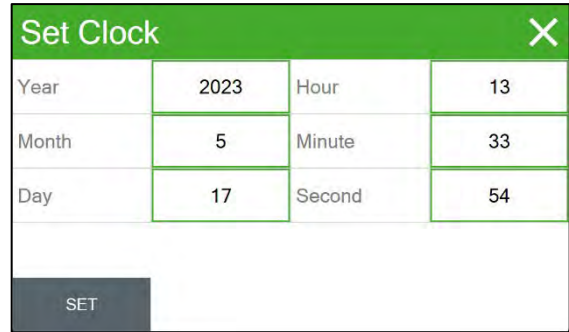

Figure 5-4 Clock Setup Screen

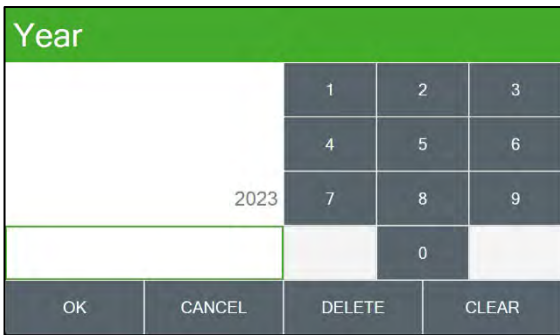



Figure 5-5 Numeric Keypad

Some parameters, such as the Date and Time settings (**Figure 5-4**) or a Unit ID value, require numeric entry. When a button to edit such a field is pressed, a visual keypad (**Figure 5-5** Numeric Keypad) will open allowing users to input the desired value. Press the OK key to accept the changes or the Cancel key to return to the previous screen. The X key  on the far right or the DELETE Key at the bottom performs a backspace operation.

Other parameters, such as the filter cassette ID value, may require alphabetical entry along with numerical values. When a button to edit such a field is pressed, a visual alphanumeric keypad (**Figure 5-6**) will open allowing users to input the value. Press the OK key to accept the changes or the Cancel key to return to the previous screen. The X key  in the lower right side performs a backspace operation.

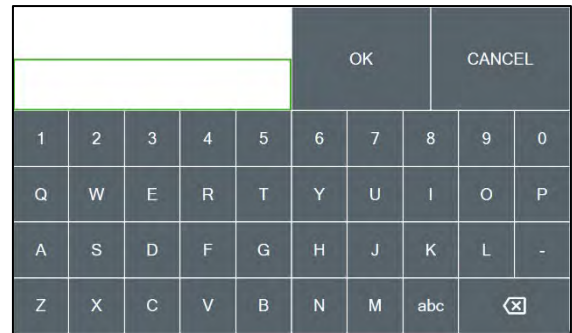



Figure 5-6 Alphanumeric Keypad

The ABC key  in the lower right-hand corner, performs the function of a SHIFT key. It toggles between upper-case and lower-case letters and allows the numbers across the top to switch to special characters such as the dollar sign, asterisk, or ampersand.

5.3 Menus

This section is broken up into sub menu headers with individual entry explanations. The 5.x.x level shows the sub menu screens and then each 5.x.x.x section shows and explains the individual entries. See the following example and repeat as needed for every menu option.

5.3.1 Operate Menu

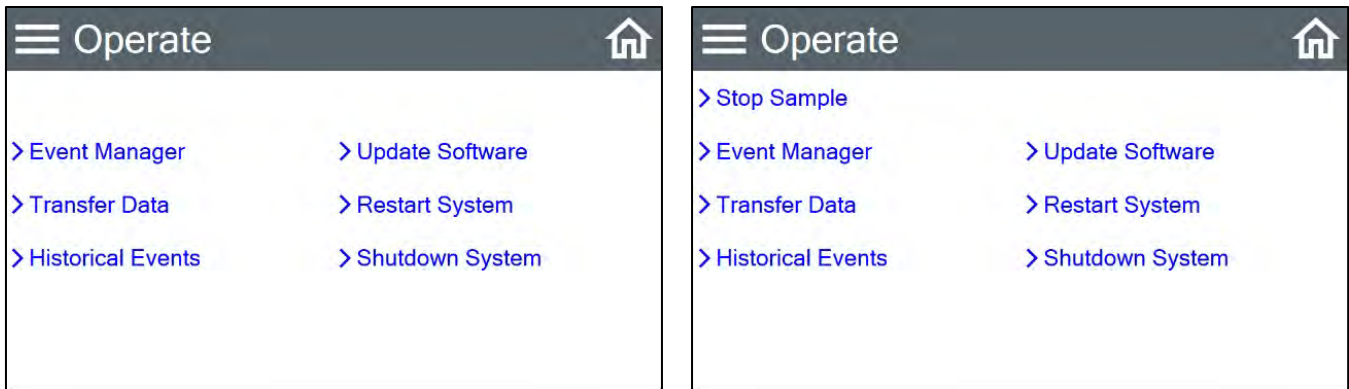

Figure 5-7 The Operate Menu

The Operate Menu is the doorway to the most commonly used areas for normal operation of the SASS/SuperSASS. Note that the appearance of the menu changes slightly when a sample event is in progress, as shown in the right-hand image of **Figure 5-7** The Operate Menu.

5.3.1.1 Stop Sample Screen

If it is necessary to stop sampling, the Stop Sample button should be used. Press the key and the warning screen shown in. Press the gray STOP button if it is necessary to completely cease operation.

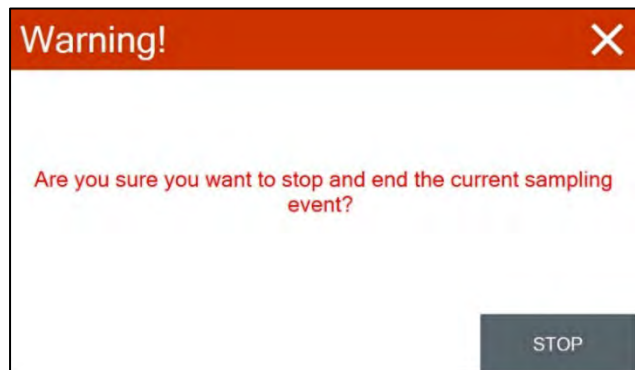

Figure 5-8 Stop Sample Screen

5.3.1.2 Event Manager Screen

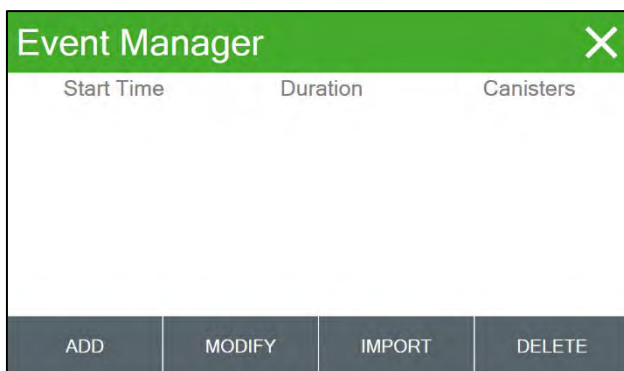

Figure 5-9 Event Manager

The Event Manager screen (**Figure 5-9** Event Manager) provides options for managing the sampling event schedule. It displays the currently programmed samples allowing for additions or providing options for removing/modifying existing events.

5.3.1.3 Transfer Data Screen

The Transfer Data screen (**Figure 5-10**) is where data can be copied to a USB thumb drive. The “All Days” box outlined in green can be selected to provide two options for data retrieval. “All Days” will copy all stored data. “Days” will provide a screen where 0 to 999 days can be selected to retrieve data for that time. See **Section 8.2.3** for more details.

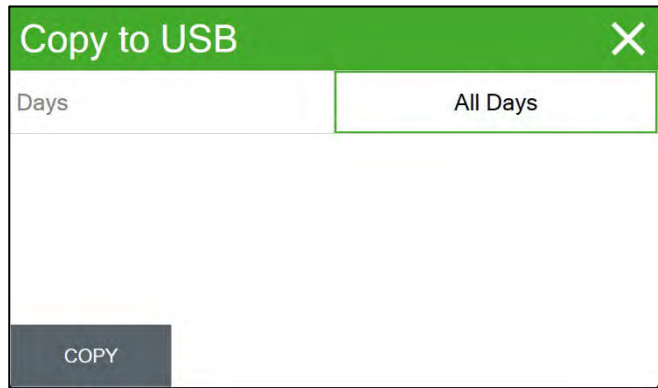

Figure 5-10 Transfer Data Screen

5.3.1.4 Historical Events Screen

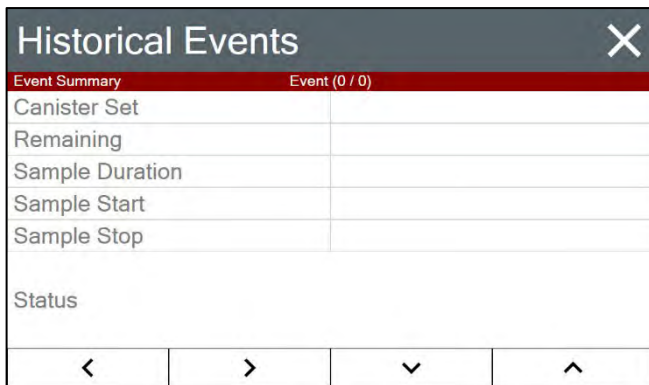

Figure 5-11 Historical Events Main Screen

The Historical Events menu will display all past events. The up and down arrows at the bottom right of **Figure 5-11** will navigate through the various options. See **Section 8.2** for more details.

5.3.1.5 Update Software Screen

The Control box software can be updated in the Upgrade Software screen. Connect a USB storage device with correct upgrade software to the control box USB port. **Figure 5-12** illustrates the upgrade screen with latest software.

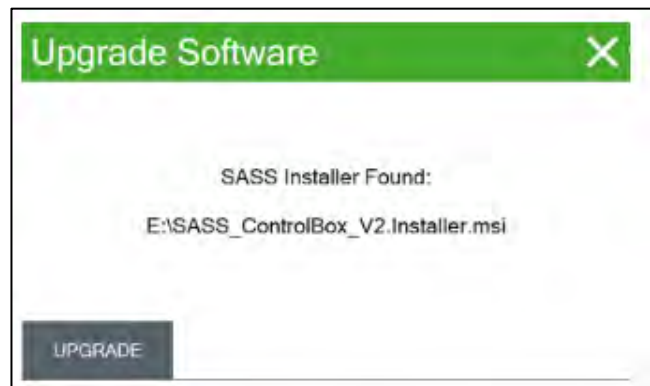

Figure 5-12 Upgrade Software Screen

5.3.1.6 Restart System Screen

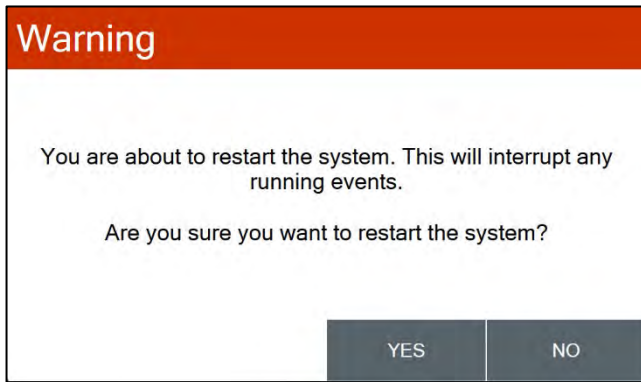

Figure 5-13 Restart System Screen

The Restart screen is used for rebooting the system if any major changes have been made. Select YES to proceed with a reboot or select no to return to the Operate menu.

5.3.1.7 Shutdown System Screen

Selecting Shut Down will prompt a warning message shown in **Figure 5-14**. Select YES to turn the system off, select NO to return to the Operate Menu.

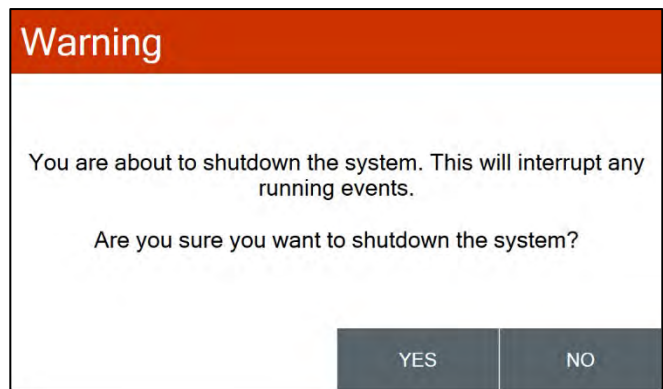

Figure 5-14 Shut Down System Screen

5.3.2 Test Menu

The Test Menu provides access to testing and calibration of individual sensor inputs.

WARNING: If the Test Menu is selected during a sample event, that event will be stopped.



Figure 5-15 Test Menu

5.3.2.1 System Test Screen

The System Test screen displays the current ambient readings along with flow and leak tests. Its primary function is to allow testing of the sensor the array. It is also useful for troubleshooting when problems are detected or for general maintenance. See **Section 9.3** for more details.

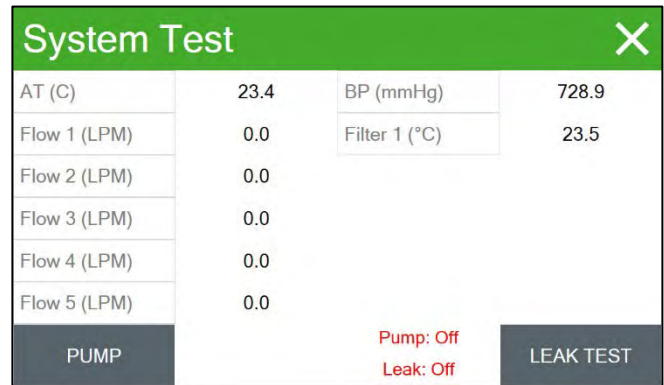

Figure 5-16 System Test Screen (SASS)

5.3.2.2 Temperature Calibrate Screen

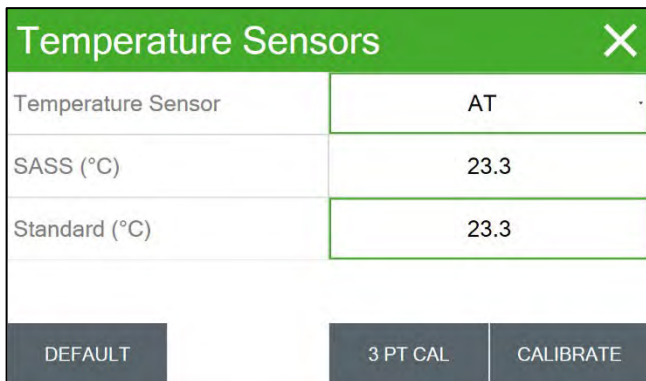

Figure 5-17 Temperature Calibration Screen

The Temperature calibration screen is used to calibrate the temperature monitoring system of the SASS. Select the temperature sensor that requires calibration using the Temperature Sensor dropdown. The name will either be listed as "AT" for the outside ambient temperature sensor or "FT1" for the first canister temperature. A 3-point temperature calibration may also be performed if needed. See **Section 9.4.1** for detailed instructions.

5.3.2.3 Pressure Calibrate Screen

This screen provides the options and indications needed to default, verify, and calibrate the SASS pressure sensor unit. This can be done as an independent verification or as part of the flow calibration procedure. See **Section 9.4.2** for more information.

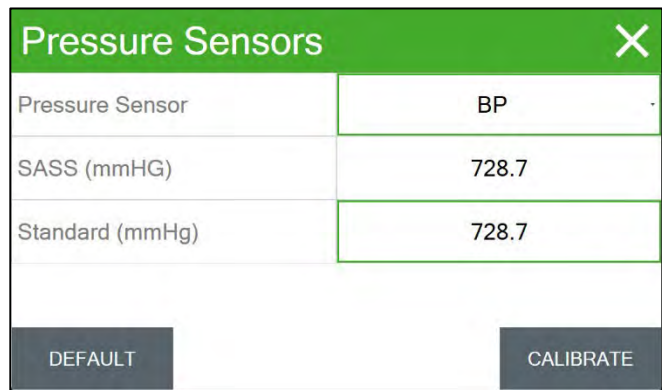

Figure 5-18 Pressure Sensor Calibration Screen

5.3.2.4 Flow Calibrate Screen

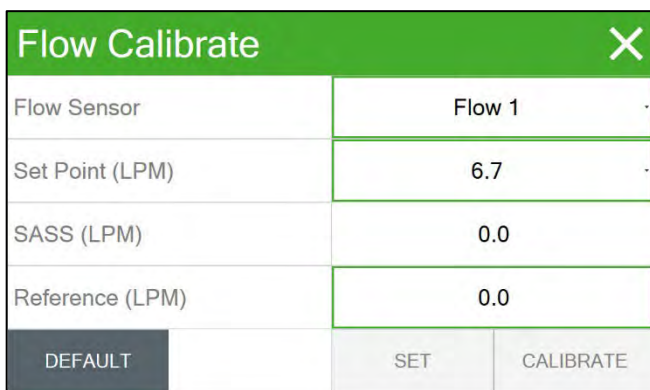

Figure 5-19 Flow Calibrate Screen

This screen provides the options and indications needed to default, verify, and calibrate the flow sensor as part of the flow audit and calibration procedures. To perform a calibration of volumetric flow, a reference standard is required. This 3-point check is made on each individual flow channel. See **Section 9.4.3** for more information.

5.3.3 Setup Menu Screen

The SASS uses a comprehensive system of setup menus which contain all the settings and parameters needed for operation of the sampler. Most of these settings are set at factory default values. Some settings may be altered by the operator. This section describes the Setup Menu in detail and should be reviewed when the instrument is first put into service. Once set, most of the values in the Setup Menus will not need to be changed. The Setup Menu values will not be lost if the SASS is unplugged or powered down.

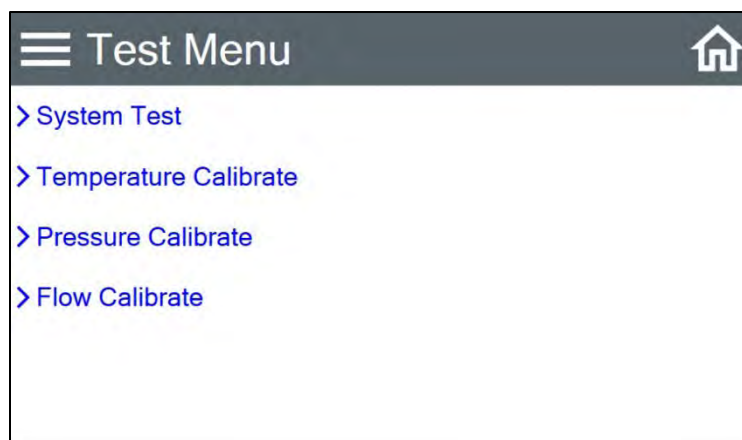
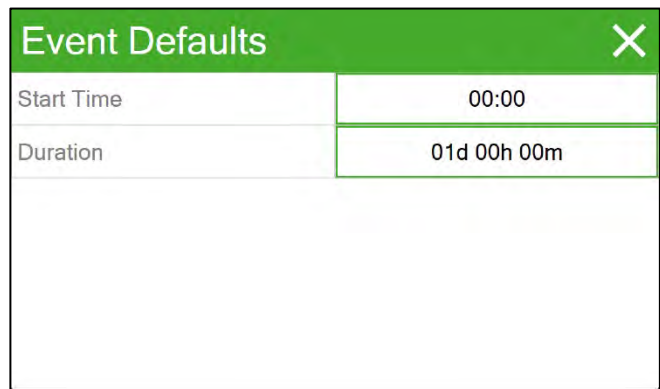

Figure 5-20 Test Menu

5.3.3.1 Event Defaults Screen

In this screen, default values for new sample events are set. These fields should be set to the most common values that are expected to be used when deploying the sampler. This will greatly reduce the required setup time when programming a sequence of sample events. Press the green box of the field that needs to be modified. Press the SET button to save each modification for Start Time and Duration.



Event Defaults	
Start Time	00:00
Duration	01d 00h 00m

Figure 5-21 Event Defaults Screen

5.3.3.2 Clear Memory Screen

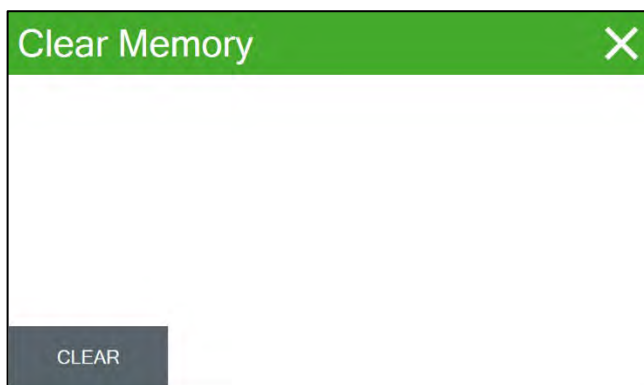

Clear Memory	
CLEAR	

Figure 5-22 Clear Memory Screen

The Clear Memory screen provides a means of clearing all the currently logged data. To clear the logged data, press the CLEAR button. This function should only be used when all data in the SASS has been collected and archived on other media such as a PC Computer. See **Section 9.5** for details.

5.3.3.3 Flow Sensor Screen

In this screen, flow sensor types are changed if flow sensors are replaced. The replacement sensor will have markings indicating if it is a 10 LPM or 20 LMP sensor. Each flow channel is listed with the corresponding flow sensor configuration next to it in an outlined green box. To change the configuration to match a replacement sensor, select the green box next to the correct channel. A dropdown will appear, select the proper flow designation to match the replacement flow sensor.

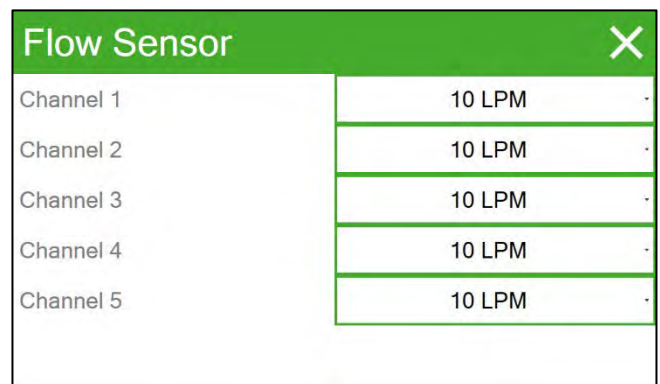

Flow Sensor	
Channel 1	10 LPM
Channel 2	10 LPM
Channel 3	10 LPM
Channel 4	10 LPM
Channel 5	10 LPM

Figure 5-23 Flow Sensor Screen

Note: This configuration is done at the factory, but it may become necessary to make a change if a field replacement is of a different type than the original.

5.3.3.4 Notification Screen

Notifications Config	
SMTP Server Address	smtp.gmail.com
SMTP Server Port	587
Use SSL	<input checked="" type="checkbox"/>
Sender's Address	
User Name	
Password	
RECIPIENTS	ENABLE
RESET	SAVE

Figure 5-24 Notification Configuration Screen

This is where the setup of notifications is performed. The unit will need to be configured with an ethernet connection (see **Section 7.2.2**) to send notifications.

5.3.3.5 Logging Screen

This is where the unit can be configured to log diagnostic data to be used for troubleshooting purposes. This should only be done at the request of Met One Instruments Service personnel and should be disabled when not in use. Trace Logging Level provides all information available, whereas Debug logging provides less information. The Logging can be downloaded by inserting a USB stick into the front of the control box and pressing the EXPORT button.

Logging	
Logging Level	None
	None
	Trace
	Debug
Export Status	Waiting for User
EXPORT	

Figure 5-25 Logging Screen

5.3.3.6 Setup Display Screen

Setup Display	
Display Brightness	50%

Figure 5-26 Setup Display

This screen allows for adjustments to be made to the display brightness.

5.3.3.7 Set Clock Screen

This is where the date and time are set. Time is a 24-hour clock only. Press the green box of the field that needs to be modified. The numerical entry keypad will be displayed allowing users to enter the value for that parameter. Once all fields have been entered, press the Set button to set the clock.

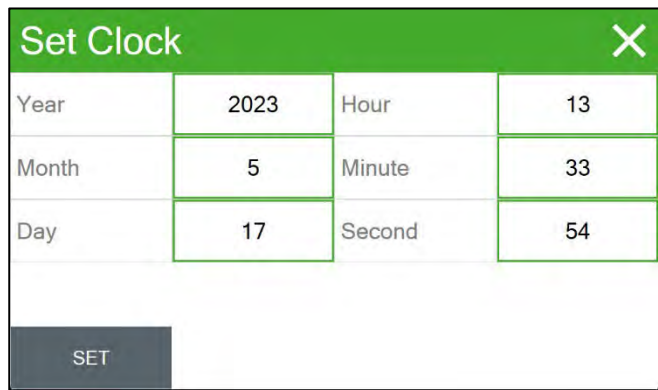

Set Clock			
Year	2023	Hour	13
Month	5	Minute	33
Day	17	Second	54
<input type="button" value="SET"/>			

Figure 5-27 Clock Screen

5.3.3.8 Unit ID Screen



Unit ID	
Unit ID	1
POC	

Figure 5-28 Unit ID Screen

Users may enter a Unit ID number up to three digits long for the SASS. Press the green bordered value box and the numerical entry keypad will be displayed. Enter the new Unit ID value. This ID number will be included in the data reports. The POC (Parameter Occurrence Code) can be entered if needed. This can be up to sixteen alphanumeric characters.

5.3.3.9 Password Screen

Menus and settings can be password protected. This screen is used to input a new password or change an existing password.

The factory-set password of Zero allows full access to all settings.

Press the green bordered value box to edit the password field. A numerical entry keypad will be displayed. Enter the new password, any one to four-digit combination may be used. When a password is set, no changes can be made to the system unless the correct password is entered.

To change the password, input the current password to unlock all settings.

Setting the password to Zero will disable the need for a password.

NOTE: The system will need to be restarted for any password changes to take effect. See Section 8.2.2.1 to restart the system.

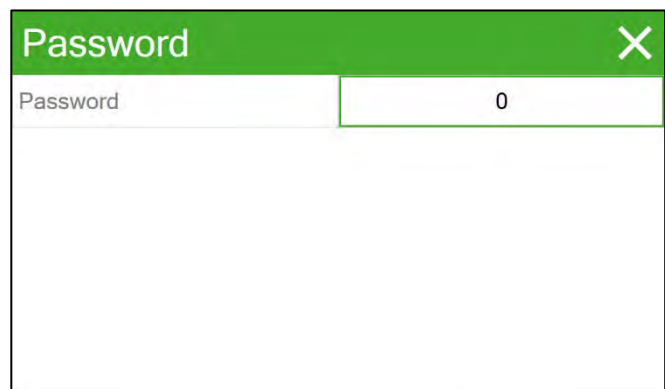

Password	
Password	0

Figure 5-29 Password Screen

5.3.3.10 Ethernet Screen

Ethernet Config	
IP Address Config	AUTO
IP Address	192.168.1.214
Subnet Mask	255.255.248.0
Gateway	192.168.0.3
MAC Address	C4:00:AD:92:B6:DD
<input type="button" value="←"/> <input type="button" value="→"/> <input type="button" value="REFRESH"/> <input type="button" value="SAVE"/>	

Figure 5-30 Ethernet Configuration Screen

This screen allows for setting/viewing the IP Address, Subnet Mask, and Gateway, and DNS Server values to allow the SASS to communicate on a local area network using a standard Ethernet cable connected to a switch or router. See **Section 7.2.1** for more details.

5.3.3.11 Remote Access Screen

This screen allows for enabling/disabling remote access to the SASS control box. The startup behavior can be set to auto or manual. A password is required to use the remote access.

Remote Access Config	
Remote Access	ENABLED
Startup Behavior	AUTO
Set Password	*****

Figure 5-31 Remote Access Config Screen

5.3.4 About Menu Screen

About	
Website	www.metone.com
Serial Number	A99999, SASS 2 83330
Firmware Revision	R1.03
Display Version	V1.0.1, Rev 590

Figure 5-32 About Menu Screen

This screen shows the monitor's serial number, installed firmware type, and version number along with Met One Instruments official web site.

6. SASS/SuperSASS SYSTEMS

A brief or detailed explanation of what happens during normal operations may be needed. If so, that information should be supplied here.

6.1 *Basic Operations*

The basic functionality of the SASS system is as follows:

1. Ambient air enters each selected canister, mounted within the solar radiation shield.
2. Particles larger than 2.5 μm ($\text{PM}_{2.5}$) aerodynamic diameter are removed by the Sharp-Cut Cyclone (SCC) inlet mounted with each canister.
3. The air sample passes through the optional denuder.
4. Remaining $\text{PM}_{2.5}$ particles are collected via filter media installed within each canister.
5. Airflow exits the canister, through the sample tubing into the pump box, through the flow control system, through the pump, and is exhausted through a muffler, located inside the pump box.

6.2 *SASS/SuperSASS Distinctions*

This section describes the differences and system functions of the SASS and SuperSASS systems.

6.2.1 *SASS Details*

The SASS has five sample channels. Each channel contains its own temperature sensor and sample canister at the head. Channels one through three use an Active Flow Control (AFC) system located in the pump. Channels 4 and 5 use a Critical Orifice (CO) in the pump box, for flow regulation see **Figure 6-1**.

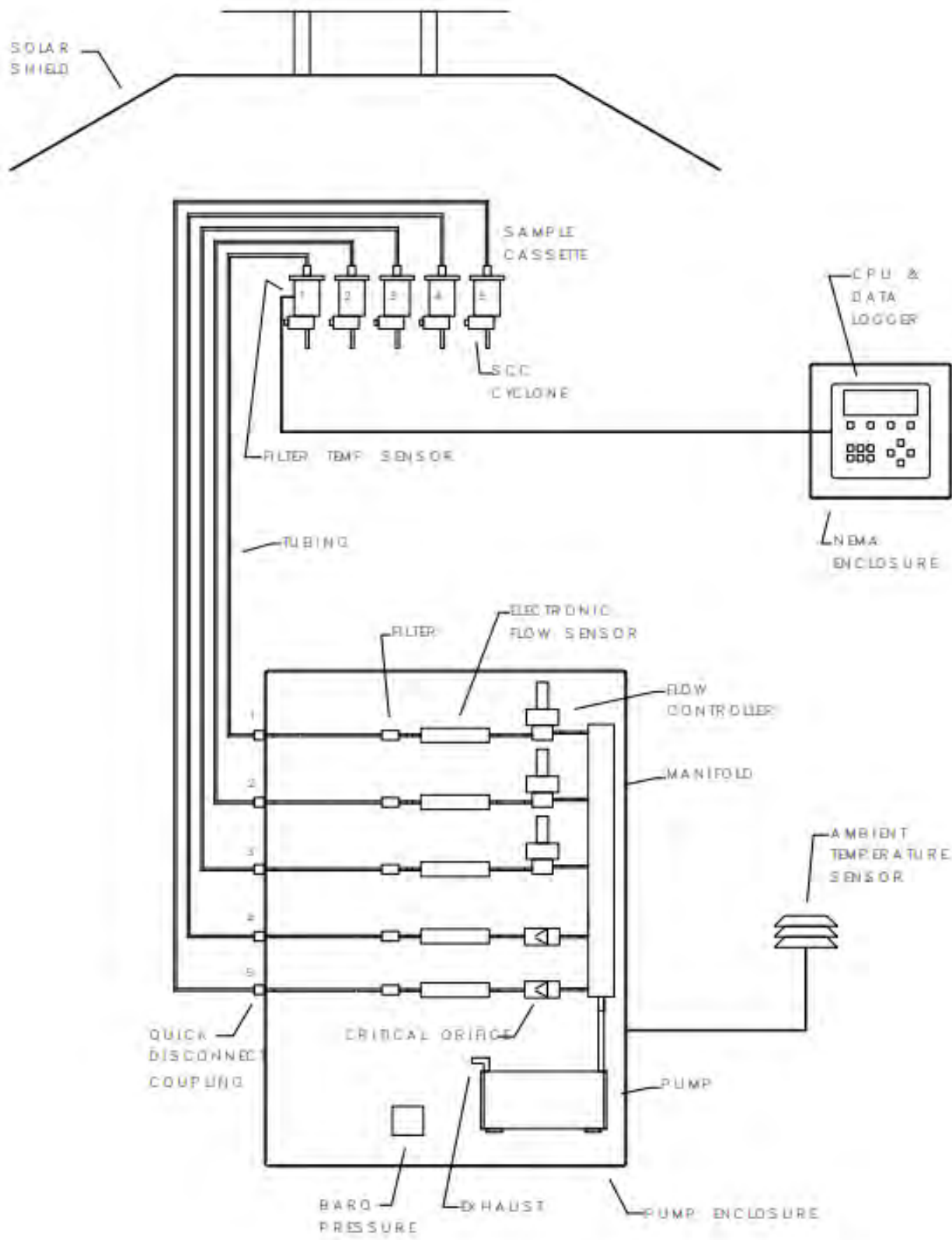

Figure 6-1 SASSFlow Diagram

Solar radiation shield, sample canisters, ambient temperature sensor, control box, and pump box.

6.2.2 SuperSASS Details

The Super SASS has eight sample channels. Each channel has a temperature sensor, and can have a sample canister connected, at the SASS sampling head. Every flow channel has a black tube that runs from the SASS head, through the tripod mast, to the pump box. All flow channels have a designated quick connect point and shut off solenoid at the pump box. The pump connect points are labeled to correspond with the correct flow channel tube, numbers one through eight. The flow channels are grouped into pairs; each pair shares an active flow control system in the pump. Each flow system is made up of one flow sensor and one active flow controller making a total of four flow control systems. This means that only four channels can be running at one time if those channels are not paired to the same flow control system. The paired flow channels are illustrated in the list below.

- Channels 1 and 5
- Channels 2 and 6
- Channels 3 and 7
- Channels 4 and 8

PLEASE NOTE: Channels sharing a flow control system cannot be run simultaneously. Example: Channels one and five share a flow control system. If channel one is running a scheduled sample, its solenoid is open, and channel 5 solenoid is automatically closed. If channel 5 is running a scheduled sample, its solenoid is open, and Channel one solenoid is automatically closed. This applies for all paired channels.

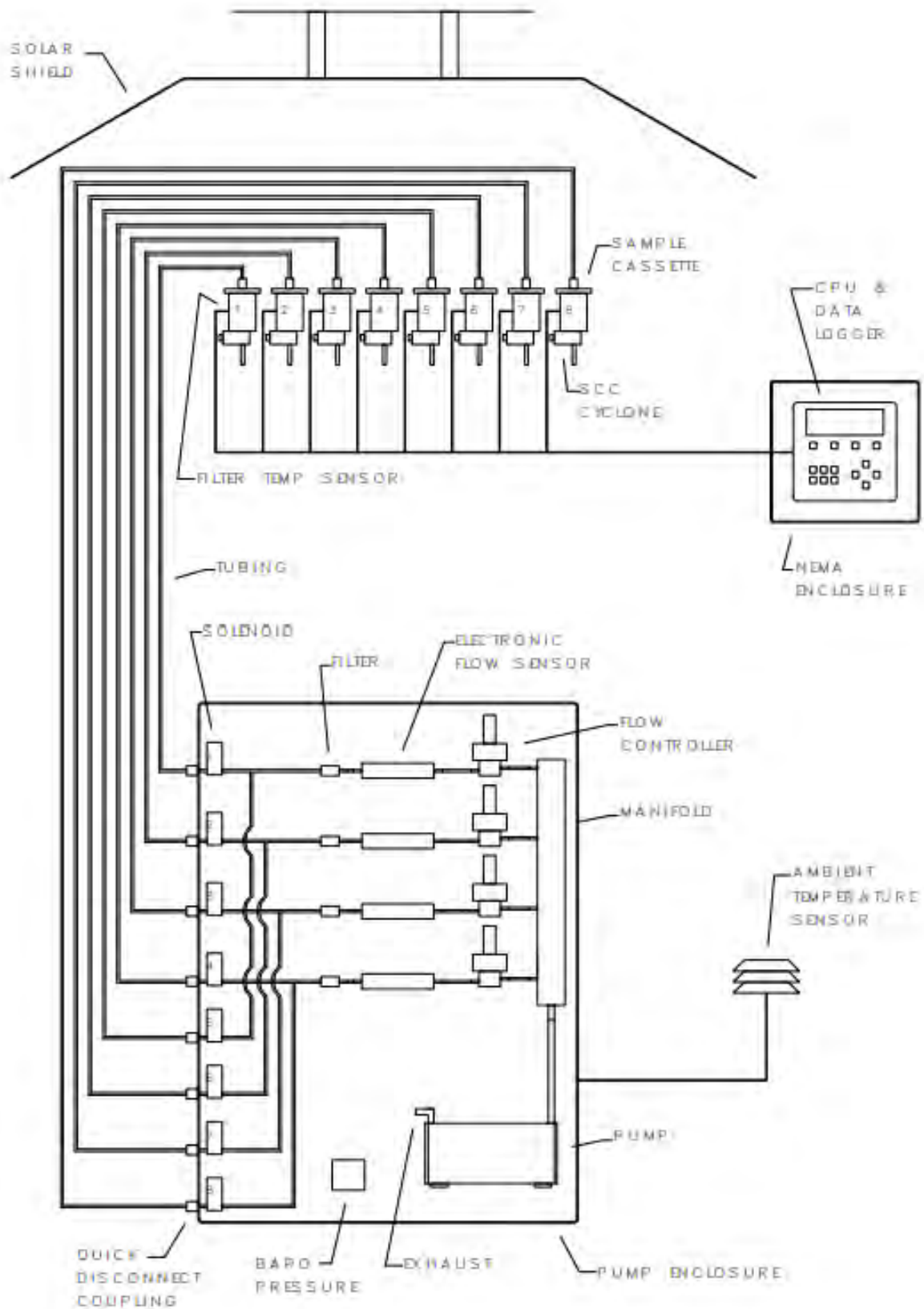

Figure 6-2 SuperSASS Flow Diagram

Solar radiation shield, sample canisters, ambient temperature sensor, control box, and pump box.

6.3 Flow System

Ambient air enters programmed channel cyclones and canisters mounted within the solar radiation shield. Particles larger than the cutoff point rating on each cyclone is discarded into the cyclone's grit pot. Remaining particles are collected on the filter media installed within each canister. Canisters may be equipped with a denuder ahead of the filter to remove selected gaseous compounds.

The SASS flow system is shown in **Figure 6-1** and **Figure 6-2**. Individual flow lines lead from each sampling canister to the pump box mounted on the ground. The flow from each canister enters a volumetric flow controller.

The shut off fitting on the side of the pump box for each canister can be used to close sample lines not in use. Vacuum lines connect to individual flow sensors then to individual flow controllers which are connected to a common manifold. The manifold leads to the vacuum pump, all of which is housed in a fan-ventilated box.

The electronic mass flow sensor measures the sample flow rate, and the processor uses the filter temperature and barometric pressure reading to calculate and control actual volumetric flow at site conditions. These volumetric flow rates are shown instantaneously on the LCD display and logged on a five-minute average in the processor data logger.

Sample flow rates can be validated manually at the canister cyclone inlet before and after each sample event using an external NIST traceable device. Note: Met One Instruments Swift 25, a low pressure bubble meter, frictionless piston or venturi is recommended to properly calibrate the flow.

7. SASS/SuperSASS CONFIGURATION

The sections below explain the process for configuring the SASS/SuperSASS for operation.

7.1 System Setup

This section explains the items in the Setup Menu and how to program the SASS/SuperSASS system for operation.

7.1.1 Clock Setup

Setting the system clock is vital for proper operation because this controls scheduled events. **Be sure to set the clock before operating this system.**

See **Section 5.3.3.7** for details on setting the system Clock.

7.1.2 Unit ID Setup

See **Section 5.3.3.8** for details on setting up Unit ID.

7.1.3 Password

See **Section 5.3.3.9** for details on setting the password. When a password is confirmed, be sure to make note of that password for future uses. If the password is forgotten, Contact Met One Instruments service department at service@metone.com for guidance.

7.2 Communication Configuration

The SASS/SuperSASS can be set up to send notifications over a network connection if available at the sample site. This section describes the procedures for setting up ethernet communications, notifications, and remote access to the system.

7.2.1 Ethernet Setup

To utilize notifications or Remote Access, an Ethernet network connection must be established. The necessary values for this connection should be provided by the site's IT department. For Ethernet communications, it is recommended to configure the SASS with a fixed IP address using the STATIC IP Address Configuration option. However, if required, setting the IP Address Configuration to AUTO will enable the monitor to operate using DHCP. In this DHCP mode, manual input of DNS settings is not required, as the automatic IP address assignment includes the necessary DNS configuration.

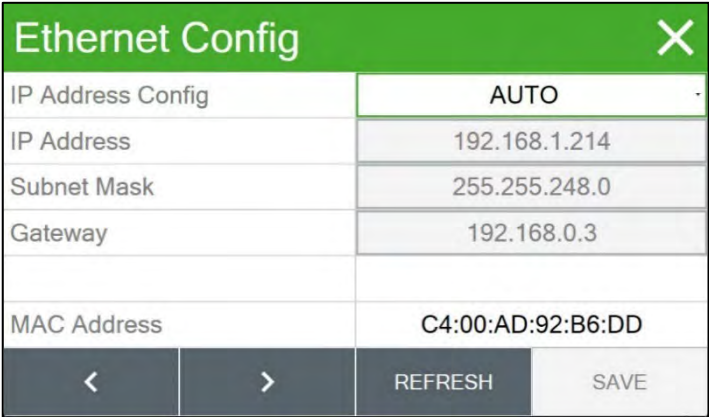

Figure 7-1 Ethernet/IP Config

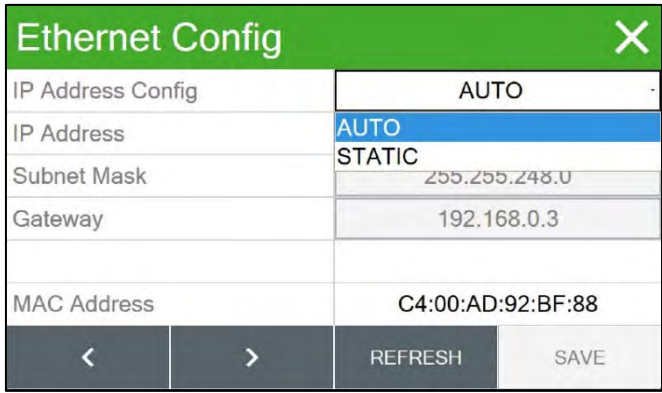

Figure 7-2 Ethernet Config Auto/Static Dropdown

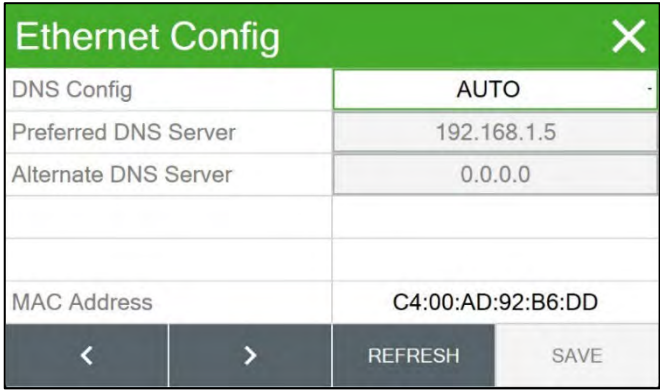

Figure 7-3 DNS Config Screen

The left and right arrows at the bottom left of the ethernet Config screen will navigate between the IP Address and DNS config screens.

7.2.2 Notifications

Set up the SMTP (Standard Mail Transfer Protocol) Server Address and Server Port. If unknown, these can be found with a quick search or contacting the email provider. Put a check mark in the box if you want to use SSL (Secure Socket Layer).

The Sender's Address is the email that will send the notifications. The Username and Password is the same as used to sign into the sender's email.

Notifications Config	
SMTP Server Address	smtp.gmail.com
SMTP Server Port	587
Use SSL	<input checked="" type="checkbox"/>
Sender's Address	
User Name	
Password	
RECIPIENTS	ENABLE
RESET	SAVE

Figure 7-4 Notification Configuration Screen

Notifications can be enabled/disabled by pressing the DISABLE/ENABLE button in the main Notifications screen.

Notification Recipients	
Recipients	
ADD	MODIFY
DELETE	

Figure 7-5 Notification Recipients Screen

Setup Recipient	
Type	Email
Email Address	Email
	Text
SAVE	

Figure 7-6 Notification Type Screen

Pressing the RECIPIENTS button will allow the user to add or modify notification recipients.

Recipients can choose to receive email or text SMS notifications. Select the box outlined in green to the right of "Type". A drop down will appear with "Email" or "Text". When the desired communication type is selected, simply input the email address or phone number and press save.

8. SASS/SuperSASS OPERATION

This section explains how to schedule events, transfer, and view data, update the system software and toggle power for the SASS/SuperSASS.

IMPORTANT: The SASS/SuperSASS system is sold calibrated, but is it recommended to audit the flow before deployment.

8.1 Event Manager

As stated in **Section 5.3.1.2**, the event manager screen is used to add new events, modify existing events, import events that have been created using FSCoMAQ software, and delete stored events.

8.1.1 Add Sample Events

Press the ADD button at the bottom left corner of the event manager main Screen (see **Figure 5-9 Event Manager**) to bring up the Event Add Screen.



The screenshot shows the 'Event Add' screen with a green header and a close button (X) in the top right. It contains three input fields: 'Start Time' with the value '2023-05-18 15:35:00', 'Duration' with the value '1d 00h 00m', and 'Canister Set' with the value '{1}'. A 'NEXT' button is located at the bottom right.

Figure 8-1 Event Add Screen

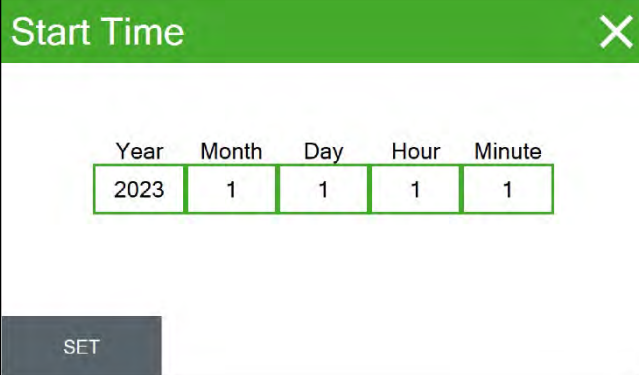

The screenshot shows the 'Start Time' selection screen with a green header and a close button (X) in the top right. It features a table with columns for Year, Month, Day, Hour, and Minute. The values are 2023, 1, 1, 1, and 1 respectively. A 'SET' button is located at the bottom left.

Figure 8-2 Event Start Time Screen

Next, set the start time by pressing on the box next to Start Time outlined in green. Change this field to indicate the desired start date and time then press Set.

Once the start time is correct, verify the duration setting. The duration is the length of time the sampler will run the pump and collect particulate on the filter media. When the desired duration is selected, press set.

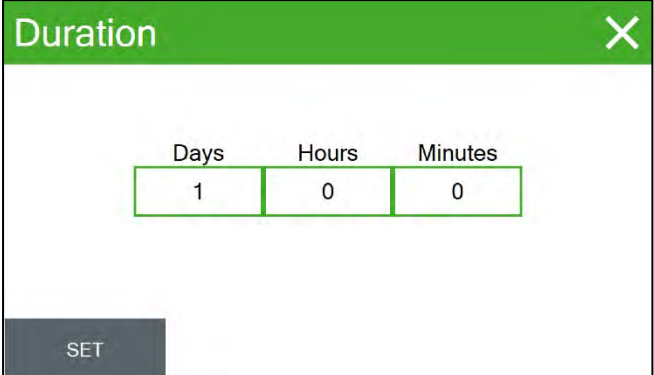

The screenshot shows the 'Duration' selection screen with a green header and a close button (X) in the top right. It features a table with columns for Days, Hours, and Minutes. The values are 1, 0, and 0 respectively. A 'SET' button is located at the bottom left.

Figure 8-3 Sample Duration Screen

Event Add	
Start Time	2023-01-01 00:00:00
Duration	1d 00h 00m
Canister Set	{1}
	{1,2} {1,2,3} {1,2,3,4} {1,2,3,4,5}

Figure 8-4 Canister Set Dropdown

Pressing the Next button on the bottom right of the Event Add screen will then open a screen to assign a Filter ID to each of the canisters in use for the event. This is an optional step and may be skipped. Press Save after entering alpha-numeric IDs for the desired canisters to add the event.

Select which canisters will run for the event in the Canister Set setting. Canisters can be grouped into sets depending on how many will be used during the sample event. {1,2,3,4,5 for SASS and, SuperSASS will add canisters 6,7,8}.

Event Add	
Canister 1 Filter ID	<input type="text"/>
Canister 2 Filter ID	<input type="text"/>
Canister 3 Filter ID	<input type="text"/>
Canister 4 Filter ID	<input type="text"/>
Canister 5 Filter ID	<input type="text"/>
	SAVE

Figure 8-5 Event Add Canister ID Screen

NOTE: Only canisters in the selected group will be seen on this screen.

8.1.2 Modifying sample events

From the Operate Menu, select Event Manager to enter the Event Manager. Programmed events will be listed on this screen.

To review the settings for a particular event, select that event and press the Modify button.

Event details will be displayed just as they were when first added. The top of the screen will be labeled Modify Event. Simply modify the parameter and press the Save button to set the changes.

Event Manager		
Start Time	Duration	Canisters
2023-08-18 00:00	01d 00h 00m	{1,2,3,4,5}
ADD	MODIFY	IMPORT
		DELETE

Figure 8-6 Saved Event

8.1.3 Importing sample events

The FSCommAQ software package can be used to create a full event schedule on a computer. This schedule can then be saved to a USB storage device and loaded into the SASS sampler instead of manually configuring each event through the front panel display of the sampler. Note that the event schedule must be configured to match the serial number of the sampler. See the FSCommAQ software manual for instructions on creating the event schedule and saving it to the USB storage device. For compatibility, USB storage devices must be formatted with the FAT or FAT32 file system.

From the Event Manager screen, select the IMPORT button to enter the USB Import interface.

If it is not already installed, insert a USB storage device containing the event schedule into the slot on the SASS control box.

Press the IMPORT button and the sampler will locate the pre-configured schedule and import it, integrating the new events with the remaining events already in the event queue.

8.1.4 Deleting Sample Events

From the Operate Menu, select the Event Manager to enter the Event Manager interface. Any programmed events will be listed on this screen.

To remove a particular event, first select it and press the Delete button. The Event Delete screen will be displayed. If this is the desired event to delete, press the Delete button to erase it.

8.2 Historical Events

Explanation of all screens and how to navigate those screens.

The Historical Events menu is comprised of nine screens. Each screen provides information for the following event subjects: Event Summary, Volume Summary, Min/Max (pages one and two), Max Delta-T, Warnings, Real Time Values and 5-Min averages.

8.2.1 Historical Events Navigation Guide

- Event Record Number indicates the number for the currently viewed event to total stored events.
- Event Navigation:
 - (Left Arrow) moves from newest to oldest events.
 - (Right Arrow) moves from oldest to newest events.
- Screen navigation arrows (up and down) move between the nine event subjects.

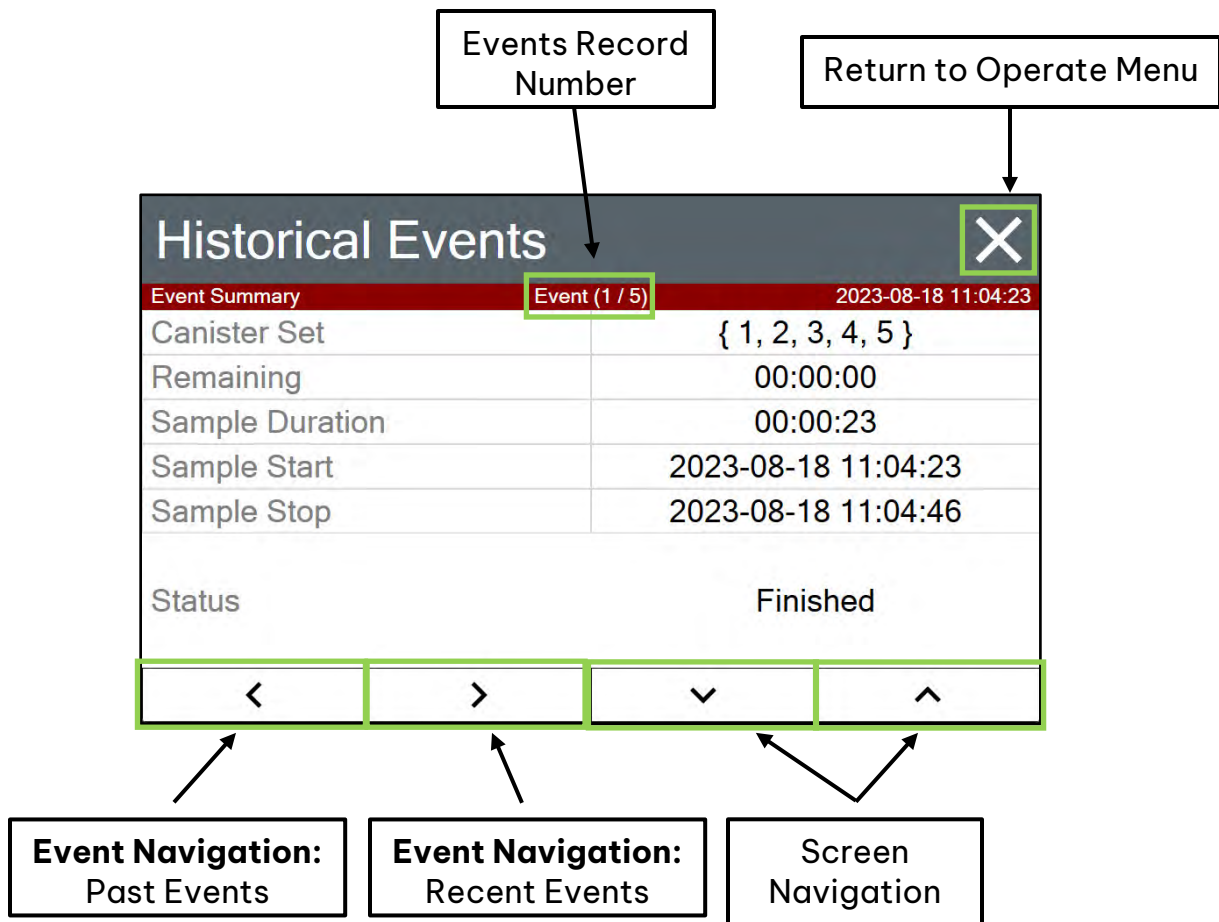

Figure 8-7 Historical Events Main

NOTE: Navigation in Historical Events remains the same for every screen.

Historical Events ✕			
Volume Summary		Event (1 / 5)	2023-08-18 11:04:23
Channel	Volume (m³)	Flow (LPM)	CV (%)
1	0.0	0.0	4688.1
2	0.0	0.0	5106.7
3	0.0	0.0	21998.0
4	-0.0	-0.0	0.0
5	0.0	0.1	1881.4
<	>	∨	∧

Figure 8-8 Volume Summary

Historical Events ✕			
Min/Max (Page 1)		Event (1 / 5)	2023-08-18 11:04:23
Channel	Max	FT Mean (°C)	Min
1	-50.8	-50.8	-50.8
<	>	∨	∧

Figure 8-9 Min/Max (1)

Historical Events ✕			
Min/Max (Page 2)		Event (1 / 5)	2023-08-18 11:04:23
Channel	Max	Mean	Min
AT (°C)	-50.8	-50.8	-50.8
BP (mmHg)	720.1	720.1	720.1
BT (°C)	36.1	36.1	36.1
<	>	∨	∧

Figure 8-10 Min/Max (2)

Historical Events ✕			
Max Delta-T		Event (1 / 5)	2023-08-18 11:04:23
Channel	Max ΔT (°C)	Occurrence	
1	0.0	2023-08-18 11:04:43	
<	>	∨	∧

Figure 8-11 Max Delta-T

Historical Events ✕				
Warnings		Event (1 / 5)	2023-08-18 11:04:23	
Elapsed Time: 00:00:20				
Channel	Warning	Filter ΔT (°C)	Warning	Flow (LPM)
1	-	-	-	-
2	-	-	-	-
3	-	-	-	-
4	-	-	-	-
5	-	-	-	-
<	>	∨	∧	

Figure 8-12 Warnings

Historical Events ✕			
Power Interruptions		Event (1 / 5)	2023-08-18 11:04:23
1		6	
2		7	
3		8	
4		9	
5		10	
<	>	∨	∧

Figure 8-13 Power Interruption

Historical Events ✕						
Real Time Values		Event (1 / 5)	2023-08-18 11:04:23			
Channel	Flow (LPM)	FT (°C)	ΔT (°C)	AT (°C)	BP (mmHg)	BT (°C)
				-50.8	718.7	35.8
<	>	∨	∧			

Figure 8-14 Real Time Values

Historical Events ✕						
5-Minute Averages		Event (1 / 5)	2023-08-18 11:04:23			
Channel	Flow (LPM)	FT (°C)	ΔT (°C)	AT (°C)	BP (mmHg)	BT (°C)
1	0.0	-50.7	0.1	-50.8	718.7	35.7
2	0.0					
3	0.0					
4	0.0					
5	0.0					
<	>	∨	∧			

Figure 8-15 5-Minute Averages

8.2.2 System ON/Off Options

There are two options to cycle the system power, Restart System and shutdown System. This section describes how to cycle the system power using the interface and the reasons for those options.

8.2.2.1 Restart System

Perform a warm reboot of the controller. Use this feature if your system is experiencing unexpected results and you want to perform a clean startup. Pressing this button will display a warning message asking for confirmation of this action. Press the Yes button to continue with the restart. Press the No button to abort this action and return to the Operate screen.

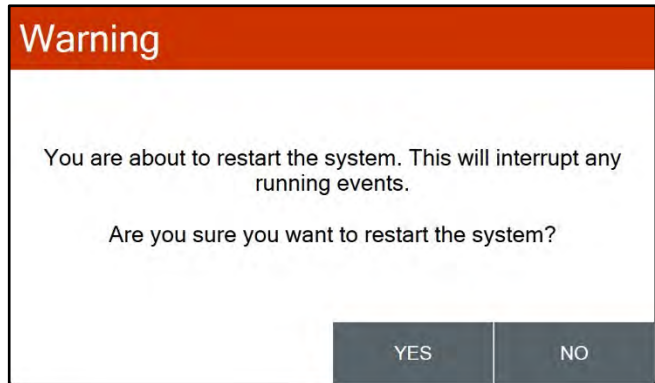

Figure 8-16 Restart Screen

8.2.2.2 Shutdown System

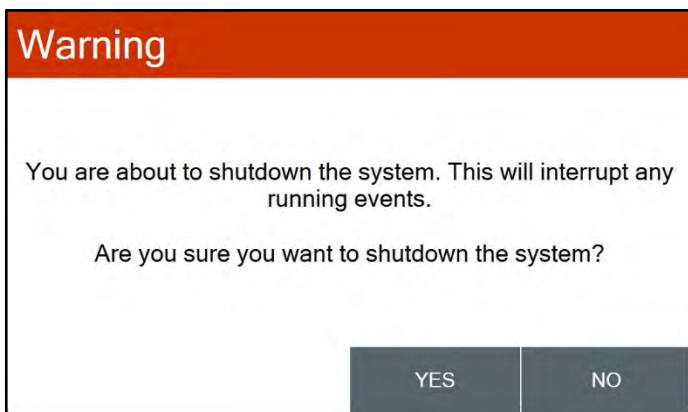

Figure 8-17 Shutdown Screen

Perform a shutdown of the controller. Use this feature to cleanly shutdown the software prior to removing power prior to disassembly and transport. Pressing this button will display a warning message asking for confirmation of this action. Press the Yes button to continue with the shutdown. Press the No button to abort this action and return to the Operate screen.

8.2.3 Data Transfer

Copying data to a USB storage device is performed from this screen.

NOTE: For compatibility, USB flash drives must be formatted with the FAT or FAT32 file system.

The Days field determines how many records will be downloaded. If it is necessary to change the number of days being copied, press the green bordered value box and the numerical entry keypad (**Figure 5-5**) will be displayed. Enter the number of days between 0 and 999. Selecting 0 will download all data.

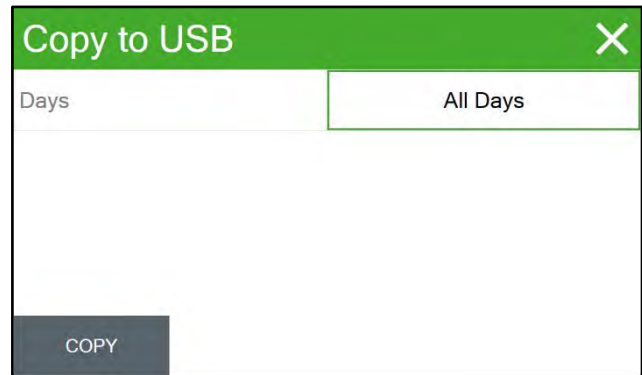

Figure 8-18 Copy to USB Screen

Data transfer will save a .BIN file containing event records and a .DAT file containing data log records. These files can be viewed and converted to .csv with the FSCommAQ software.

8.2.3.1 Remote Access

Data stored in the SASS system can be downloaded remotely when a network connection is established using FSComAQ software. The software can be accessed at metone.com and downloaded onto a computer.

See **Section 5.3.3.11** for details on setting up Remote access.

9. MAINTENANCE and TROUBLESHOOTING

This section provides information about routine maintenance, identifying errors and performing diagnostic tests if a problem is encountered. The TEST menu functions are also described in this section.

Little maintenance is required for the operation of the SASS Sampler System. The following procedures should be followed for reliable continuous operation of the system. Most maintenance involves inspection of components for damage or wear, as well as performing regular checks and calibrations of the system. It is recommended that all maintenance and troubleshooting activities be recorded in the site notebook.

The SASS system contains both electronic and pneumatic components. Historically the vacuum pumps of most ambient air sampling systems require at least annual maintenance. The dual headed Thomas™ diaphragm pump used in the SASS can be removed by the operator from the field and new diaphragms and valves placed into the pump ensuring another year of operation without failure.

The O-rings used in the SASS are made from Viton™ rubber. These O-rings should continue to provide a leak free system for several years. However, if leaks are detected during operation or during leak checking, these O-rings could be leaking. It is recommended to replace O-rings every two to three years depending on use and wear. However, they should be inspected on a regular basis.

9.1 Recommended Periodic Maintenance Table

Table 9-1 shows the recommended interval for the regular maintenance, field checks, and service tasks.

Table 9-1 Recommended Maintenance Schedule for the SASS/SuperSASS Sampler

Maintenance Item	Period
Leak Check	Monthly
Flow system check/audit.	Monthly
Ambient and flow temperature sensor check/audit	Monthly
Clean PM _{2.5} cyclone particle trap.	Monthly
Check or set real-time clock.	Monthly
Verify proper pump and box fan operation.	Monthly
Inspect canister, cyclone,	Monthly
Complete flow system calibration.	Quarterly
Completely disassemble and clean PM _{2.5} cyclones.	Quarterly
Inspect and replace internal debris filters as needed.	6 Months
Rebuild vacuum pump (use rebuild kit)	Annually
Replace O-rings	Annually
System Cleaning	Quarterly

9.2 System Maintenance

Each time the system canisters are replaced, or as deemed necessary, the solar radiation shield of the sampler head should be cleaned with a wet cloth or, if required, a dilute soap and water solution. Dirt buildup on the shield can reduce the effectiveness of the reflective surface and cause the temperature to rise inside the shield.

The pump housing should be inspected and cleaned at least every quarter by removing the four screws on the corners and lifting the cover up and out of the way. Using a brush, or a compressed air source, clean the insides of the enclosure and in particular, the screen located below the pump assembly. When completed, replace the cover by tightening down the two screws located on the fan exhaust side first, and then “snug” the two screws on the opposite end of the enclosure.

The control box and cables should be inspected for damage or dirt and dust accumulation. The control box can be cleaned with a wet cloth or if required a diluted soap and water solution. The screen of the control box electronics should not be cleaned with a damp cloth, and no liquids should be allowed to enter the electronics package.

9.2.1 System Inspection (during normal operations)

As part of normal maintenance and operation, various components of the system should be inspected for wear and damage. Most inspections rely on visual checks during normal operation and should be performed regularly.

- Inspect the SASS Head radiation shield (round flat disk mounted above the SASS head) for excessive buildup of dust and dirt.
- Check black vacuum hoses and quick connectors for any wear or damage.
- The control box, cables and connectors should be inspected for corrosion, damage, dirt, or dust accumulation. (Connector contact points, male connector pins and mating connectors, can develop corrosion over time.
- Each time canisters are removed, visually inspect canister and SCC O-rings for cracks or damage.
- Each time the cyclones are removed, unscrew grit pot (See **Figure 4-12**), and dump out any dirt that may have collected as part of a routine maintenance program.
- Confirm all tripod anchor points.

9.2.2 System Cleaning

Dirt buildup on the SASS head radiation shield can reduce effectiveness of the reflective surface and cause the temperature to rise inside the shield. A wet cloth or, if required, a diluted soap and water solution can be used to clean buildup on most surfaces. When the system canisters are replaced (as deemed necessary), inspect the sampler head solar radiation shield for excessive buildup. The pump housing should be inspected and cleaned at least every quarter by removing the four corner screws and lifting the cover off the chassis. Using a brush or a compressed air source, clean inside the enclosure as well as the screen located below the pump assembly. When completed, replace the pump box cover by sliding it back into place. Tighten the two screws located on the fan exhaust side first, and then snug the two screws on the opposite end of the enclosure.

The control box can be cleaned with a wet cloth, or if required, diluted soap and water solution. The control box electronics screen should only be cleaned with a soft, dry cloth, and no liquids should be allowed to enter the electronics package.

9.2.3 Denuder Replacement

Following the normal test sequence of the EPA Trends network, the MgO denuder will need replacement approximately every three months of operation or as required by the US-EPA. Under the EPA Trends program, the denuders are replaced by the third-party vendor performing the analysis of the filters. The third-party vendor is replacing filters and denuders in each canister; sufficient denuders should be supplied based on the three months of operation being typical.

Met One Instruments recommends that the MgO coated aluminum multicell coated material be provided by Met One Instruments. Customers who wish to do their own coating can contact Met One Instruments for cut and cleaned multicell material which is

pushed into the Denuder sleeve aluminum ring for use in the sampling canister. Customers can purchase Multicell aluminum material from a sole source manufacturing company but that material must be cleaned and properly coated.

Operational life expectancy of the MgO coated aluminum Denuder is six months in an urban airshed like Los Angeles. Re-coating of the material is not practical nor recommended.

The Met One Instruments MgO Coating Procedure for replacement denuder material is detailed below.

NOTE: Users should consult the factory for the correct coating process.

NOTE: Laboratory Safety and Personal Protection Procedures Shall be applied.

WARNING: Use of gloves and a respirator is required.

1. The aluminum multicell material is washed in an ultrasonic bath under an explosion-proof fume hood for five minutes using methanol.
2. Air dry to complete dryness. Use of filtered laboratory air is necessary for quick drying.
3. Pour approximately 150ml of methanol (CH₃OH) into a clean glass beaker.
4. Place a #150 mesh Stainless Steel screen over the top opening of the beaker.
5. Using gloves, place MgO power reagent on top of the screen and using a clean spatula press the MgO through the screen into the CH₃OH.
6. Mix thoroughly.
7. Using gloves, hand dip the multicell material into the slurry by dipping both one side and then the other to thoroughly coat the internal surfaces of the hexagonal cells.
8. Using filtered laboratory air in a hood, rotate the coated multicell material and blow-filtered air over the surface until the MgO starts to dry to the touch. Approximately 1 minute is necessary before it can be set down.
9. Set coated denuder in clean area and let dry 24 hours before packaging or use.

9.3 System Test/Leak Check

System Tests and leak checks are done from the System Test screen of the Test Menu. This screen runs a function check of all major sensors which include Temperature, Pressure, and flow.

Before a leak test can be done the flow control valves must be operating at 6.7 LPM (+/- 0.2). Check for this operating point by pressing the PUMP button to turn the pump ON and wait at least 5 to 10 minutes for the 6.7 LPM operating point to be reached. Once this operating point has been reached press the LEAK TEST button to put the unit in leak test mode (Note: The leak test mode turns OFF motor control to the flow control valves).

System Test X			
AT (C)	23.4	BP (mmHg)	728.9
Flow 1 (LPM)	0.0	Filter 1 (°C)	23.5
Flow 2 (LPM)	0.0		
Flow 3 (LPM)	0.0		
Flow 4 (LPM)	0.0		
Flow 5 (LPM)	0.0		
PUMP		Pump: Off Leak: Off	LEAK TEST

Figure 9-1 System Test Leak

While the pump is operating and flow values are being displayed, block off the inlet tube of the Cyclone of canister #1. The flow value for Flow 1 should drop to a 0.0 or 0.1 LPM, indicating that there are no detected leaks in the components of the first canister. Continue this procedure for the remaining canisters and make sure the flow drops to a 0.0 or 0.1 LPM. A flow reading greater than this, on any of the canister channels, indicates that there is a leak in that portion of the system. Testing individual sections of the system can identify the location of the leak.

9.3.1 System Leak Check Procedure

1. Disconnect the vacuum line from the sample head at the side of the pump box. The flow for that channel should drop to 0.0 LPM. This indicates that the leakage path is between the pump and the sample head.
2. Reconnect the vacuum line to the pump box. Remove the canister from the sample head and block off the vacuum line connection that would have been inserted into the canister. If the flow value drops to 0.0 LPM, then the leakage is either in the connection between this point and the canister or the cyclone.
3. Remove the cyclone from the canister and plug the bottom of the canister. Install the canister in the sample head and examine the flow value. It should drop to 0.0 LPM. If it indicates a leak then the seal between the sample head and the canister is at fault (check to see if the O-rings are in good condition). The other possibility is that the canister is not correctly assembled and a leakage path around the two sections of the canister exists. A 0.0 LPM reading would indicate the problem is in the cyclone.

- Replace the cyclone on the canister; if the flow channel indicates a leak, then the problem is with the cyclone. Verify that the O-ring seals on the cyclone are intact and have not been damaged. If they are cut or have any other type of damage, they must be replaced. If the flow reads 0.0 LPM then the problem is fixed, and there is no leakage in the system. The original indication was probably caused by a poor initial connection when the canister or cyclone was installed in the sample head. This now verifies that the vacuum system is intact, and everything is working correctly.

9.4 Calibration Procedures

The calibration procedure performed in the field for the SASS is flow rate measurement, filter temperature, ambient temperature, and barometric pressure measurement. Using a set of NIST traceable standards, for volumetric flow, barometric pressure and temperature, the SASS unit can be easily calibrated using the calibration screens in the Test Menu of the SASS Control Unit.

Note: Before performing any calibrations, allow the system to warm up for at least forty-five minutes.

9.4.1 Temperature Calibration

Temperature sensor audits and calibrations are performed in the Temperature Calibrate Screen of the Test Menu. Before beginning it will be necessary to have a reference temperature measurement device that has a calibration traceable to NIST or other approved calibration authority.

To perform an audit, select the temperature sensor that is to be audited. The name will either be listed as “AT” for the outside ambient temperature sensor and “FT1” for canister 1 temperature. SASS. This is initiated by pressing the 3 PT CAL button.

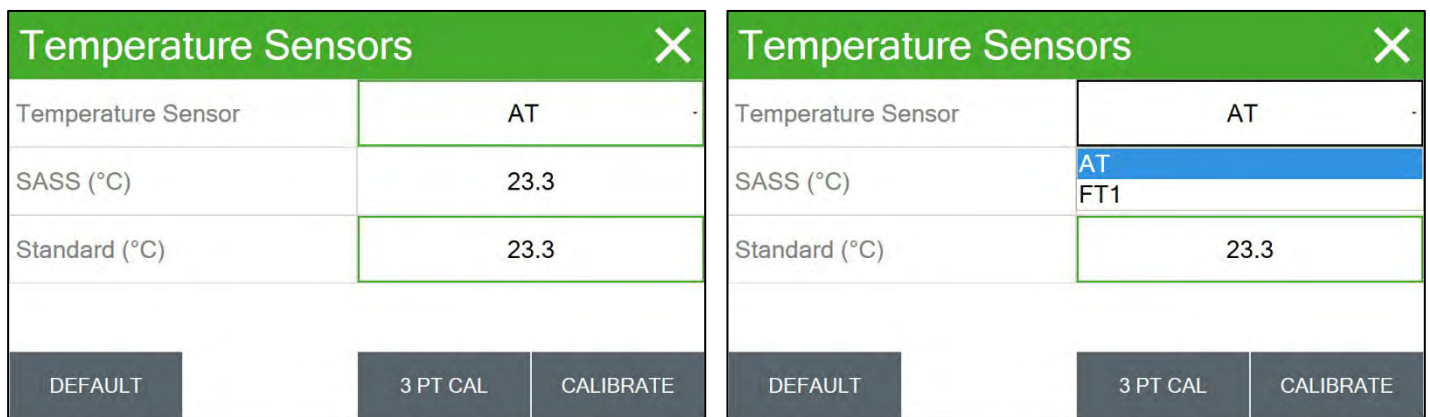

Figure 9-2 Temperature Calibrate Screen with Selection Choices

One good reference point for the ambient temperature sensor measurement is “ice point” (0°C / 32°F) the second being some elevated temperature above 20°C. During the summer, the local ambient temperature may provide a suitable second temperature for calibration. The ice bath consists of a slurry of distilled water and ice chips that has been stirred to produce a 0°C temperature bath as measured with the reference thermometer. A wide mouth thermos bottle works well for temperature tests.

The screenshot shows a mobile application interface titled "3 Pt Temp Cal" with a close button (X) in the top right corner. The interface is divided into several sections:

- Set Point:** A dropdown menu currently set to "Ambient".
- Temp Sensor FT1 (°C):** A dropdown menu with three options: "Hot", "Ambient" (which is highlighted in blue), and "Cold".
- Reference (°C):** A text input field containing the value "23.3".
- Buttons:** Two large buttons at the bottom, "DEFAULT" on the left and "CALIBRATE" on the right.

Figure 9-3 3 Point Temp Calibration Screen

Remove the ambient temperature probe from the shield by removing the three hexagonal nuts that hold the ring in place under the shield. Now using the ice point bath with the reference thermometer, immerse the sensor portion of the ambient temperature probe into the ice mixture. After about 1 minute of time to allow for stabilization, compare the displayed value of the Temp Sensor AT to the reference thermometer. The temperature should be within $\pm 2^{\circ}\text{C}$ of the reference thermometer. Next using a second thermos bottle with a warm water mixture of approximately 30°C immerse the temperature probe and compare the reference thermometer in the bath with the measured value indicated for Temp Sensor AT. The temperature should be within $\pm 2^{\circ}\text{C}$ of the reference thermometer. If both measurements are within the temperature tolerance, then it is not necessary to calibrate the ambient temperature probe. If the temperature is more than the tolerance, use the following procedure to reset the calibration of the ambient temperature probe.

1. In the 3 Pt Temp Cal screen, change the Set Point to Ambient.
2. Place the reference temperature sensor near ambient temperature sensor as close as practical. Allow the sensors enough time to fully equilibrate. Enter the value measured from the reference temperature sensor in the bottom Reference window. Press the CALIBRATE button on the bottom right of the screen.
3. In the 3 Pt Temp Cal screen, change the Set Point to Cold.
4. Insert the probe in the ice bath with the reference temperature sensor and allow several minutes for the measurements to stabilize. It is best to try and stir the bath while both probes are in the ice mixture. When the probes are stable, enter the value measured from the reference temperature sensor in the bottom Reference window. Press the CALIBRATE button on the bottom right of the screen.
5. Change the Set Point to Hot.

6. Now insert the probe in the heated water mixture and allow time for the probe and the reference thermometer to stabilize. When the probes are stable, enter the value measured from the reference thermometer in the bottom Reference window. Press the CALIBRATE button on the bottom right of the screen.
7. This calibrated the temperature probe to the reference temperature sensor. Re-run the temperature checks previously outlined and verify that at the two measurement points the temperatures are within the $\pm 2^{\circ}\text{C}$ tolerance. If they are not, press the DEFAULT button to return the sensor to its factory default settings and then rerun the calibration test one more time.
8. If it fails the test a second time, there is the possibility that the temperature probe is damaged and will need to be replaced. If a new probe is installed, be sure to set the replacement probe using the “DEFAULT” button. This will return to the original measurement factors.

This same procedure can also be used for the filter temperature measurement, except for the temperature check, use the local ambient temperature as a single reference point. From the Temperature Calibrate screen (refer to **Figure 9-2**), select FT1. Insert a temperature probe into the open hole after canister #1 has been removed. Allow 10 minutes for the temperatures to stabilize, and then compare the reference thermometer with the filter temperature screen. They should be within $\pm 2^{\circ}\text{C}$ of each other. If the error is greater, enter the value measured from the reference thermometer in the bottom Reference window and press the CALIBRATE button.

9.4.2 Pressure Calibration

The Pressure Calibrate screen provides the calibration screen for the calibration of the pressure sensor in the SASS unit. The pressure is used by the flow monitoring system to determine the volumetric flow from the measured mass flow sensors.

Pressure Sensors	
Pressure Sensor	BP
SASS (mmHG)	728.7
Standard (mmHg)	728.7

DEFAULT
CALIBRATE

Figure 9-4 Pressure Calibrate Screen

Compare the current SASS pressure measurement with a reference barometer to make a preliminary audit check. The pressure indicated for the SASS should be within ± 10 mmHg of the reference pressure device. If the measurement is more than this value, then it is necessary to recalibrate the pressure sensor in the SASS.

Enter the barometric pressure value from the reference in the Standard box and press the CALIBRATE button. If the SASS pressure does not change to within 10 mmHg of the reference standard, press the DEFAULT button to return the sensor to its factory default settings and then rerun the calibration test one more time.

9.4.3 Flow Audit and Calibration

The Flow Calibrate screen provides the calibration screen for the calibration of the flow sensor in the SASS unit.

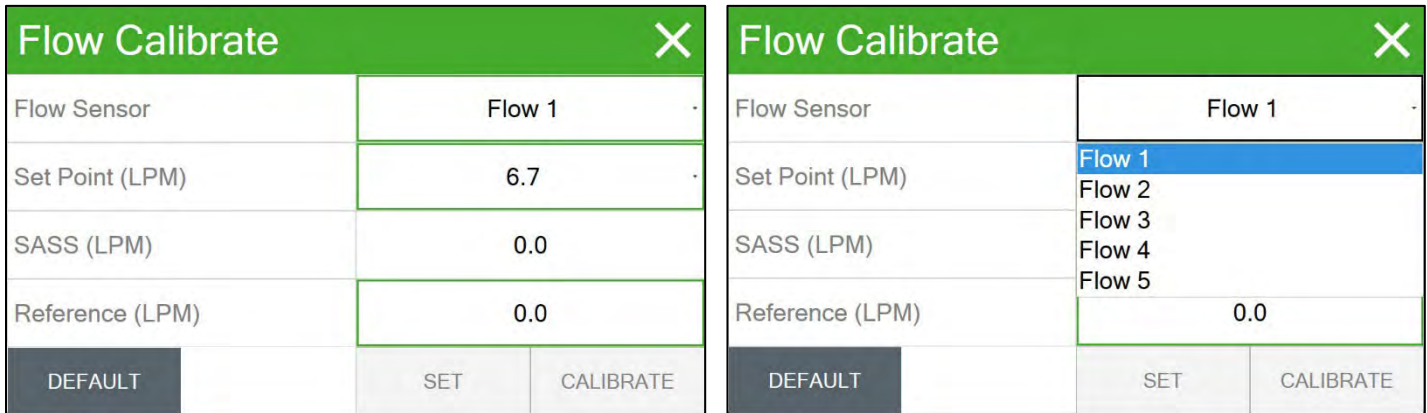

Figure 9-5 Flow Calibrate Screen

It will be necessary to have some type of reference flow device that has a calibration that is traceable to NIST, or some other approved calibration authority before beginning the calibration. The best type of flow unit to use is one that is a direct reading device that has minimal inline flow restriction. Some of the flow measurement devices can restrict the flow to a point that it is difficult to measure at the operating flow rate of the system.

It is recommended that the SASS pump be run for approximately 20 minutes to allow the flow system to reach operating temperature before performing a flow calibration.

Using a flow test device, and any adapter that might be necessary to adapt to the input tube of the cyclone, measure the flow at each of the canisters. The cyclone inlet adapter part number 8959 can be used. Use the Flow Sensor drop down menu to select each of the flow line positions. The SASS has 8 flow monitors. These drop-down selections are used to change the channel being monitored. All measured flows should be within +0.1 to -0.2 LPM of the reference standard or 6.6 to 6.9 LPM with a target of 6.7 LPM. If any value is more than this tolerance, enter the value of the reference in the Reference box and then press the “SET” button for each Set point. Then press the “CALIBRATE” button to recalibrate the channel. This will enter in the correctly measured value for that channel. Use this same procedure for any other channels that may require recalibration.

If the flow sensor does not regulate to the flow set point after performing the calibration, press the “DEFAULT” button to return the sensor to its factory default settings and then rerun the calibration test one more time.

9.4.4 Flow Sensor Replacement

If it is found that flow sensors need to be replaced, See **Section 5.3.3.3** Flow Sensor for instructions on adjusting settings for the replacement sensors.

9.5 Clear Memory

The Clear Memory screen provides a means of clearing all the currently logged data. To clear the logged data, press the CLEAR button. This function should only be used when all data in the SASS has been collected and archived on other media such as a PC Computer using FSCommAQ software.

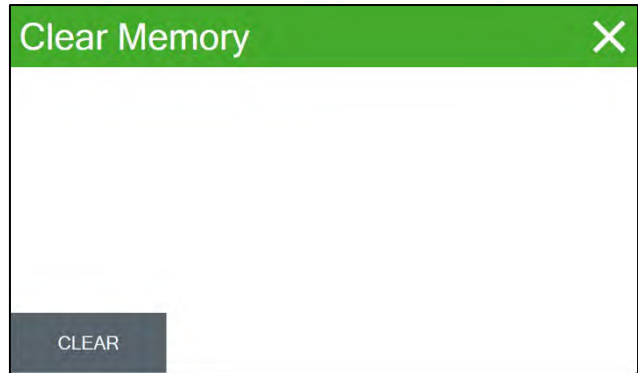

Figure 9-6 Clear Memory Screen

IMPORTANT: It is recommended to clear the SASS memory after data is transferred or downloaded to an external storage device or local network.

9.6 Basic Problem and Cause/Solution Table

The following table contains information on some of the more common problems that may be encountered, and some steps to identify and remedy the problems. Met One Instruments welcomes customer suggestions for new items to include in this section of future manual revisions. If the solution cannot be found in the following table, then contact one of our expert service technicians for help in resolving the problem.

Problem:	The airflow won't regulate at the correct rate of 6.7 lpm.
Cause/Solution:	<ul style="list-style-type: none">• This usually indicates that the air pump is losing vacuum capacity due to wear.• Check for leaks. Leaks will often cause the inlet flow to be low even though the flow sensor is measuring the correct flow rate. This is because the flow sensor is downstream of the filter cassette. Correct any leaks found.• Perform a flow calibration. If the flow regulates at the lower calibration point, but not the higher point, the pump is probably worn out or there is a leak.• Check the inlets, hoses (in pump and from sample head), and PM heads for obstructions.

Problem:	The sampler has flow leaks, even after cleaning.
Cause/Solution:	<ul style="list-style-type: none">• Check the O-rings on the very sharp-cut cyclone (if used). These frequently leak.• Check for bad O-rings on all other components.• Check all of the push-in air fittings throughout the air flow system.

Problem:	The clock settings are lost when the SASS is powered down.
Cause/Solution:	<ul style="list-style-type: none">• There is a lithium coin cell battery inside the mass monitor that maintains the clock when the mass monitor is powered off. The battery may need to be replaced if the clock resets when the mass monitor is powered off.

9.7 Additional Error Correction Instructions

9.7.1 Link Down Error

Error occurs when communication is lost with pump box. Warning may resolve itself. If the warning continues, consult Met One Instruments service department.



Figure 9-7 Link Down Screen

10. DATA RETRIEVAL

The following sections explain the process and tools required to retrieve data from the SASS. The SASS can copy data files directly to a user-supplied USB storage device. The SASS control box can be connected to a local network via an ethernet cable to download data using Met One Instruments FSCoMAQ software.

10.1 USB Memory Device

The SASS can copy data files directly to a user-supplied USB storage device. This drive must be installed in the USB port located on the control box panel.

IMPORTANT: For compatibility, USB storage devices must be formatted with the FAT or FAT32 file system.

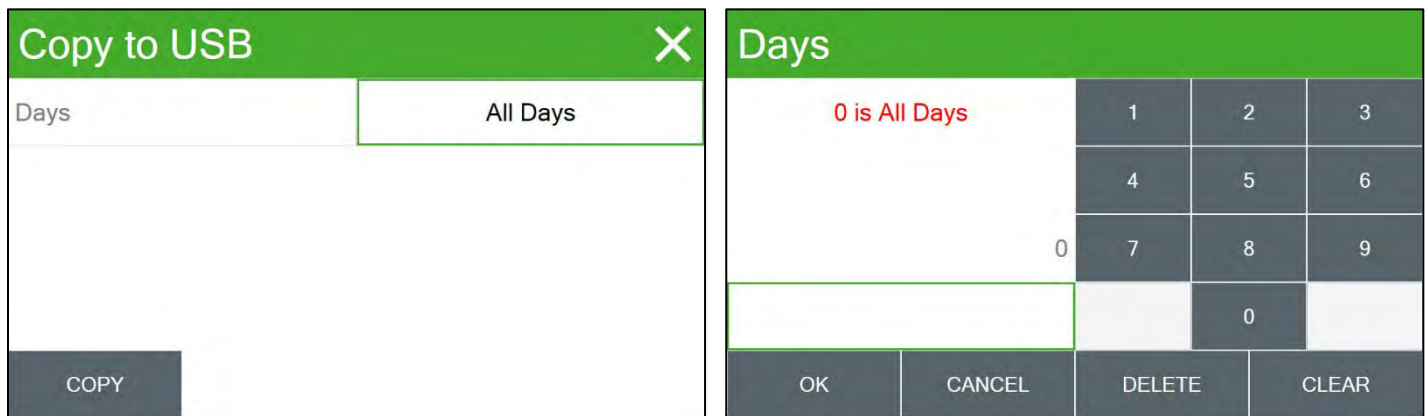

Figure 10-1 Copy to USB Storage Device

Copying data to a USB memory stick is performed from this screen. For compatibility, USB storage devices must be formatted with the FAT or FAT32 file system.

The Days field determines how many records will be downloaded. If it is necessary to change the number of days being copied, press the green bordered value box and the numerical entry keypad will be displayed. Enter the number of days between 0 and 999. Selecting “0” will download all data.

Data transfer will save a .BIN file containing event records and a .DAT file containing data log records. These files can be viewed and converted to .csv with the FSCoMAQ software.

10.2 FSCommAQ Software

The FSCommAQ software and manual are available from the Met One Instruments website at www.metone.com/software. Software version 1.4.11 or higher must be used with SASS systems.

Data retrieved from the SASS can be viewed and converted to .csv or .txt file format using the FSCommAQ software package.

The FSCommAQ software package can be used to create a full event schedule on a computer. This schedule can then be saved to a USB storage device and loaded into the I-SASS sampler instead of manually configuring each event through the front panel display of the sampler. Note that the event schedule must be configured to match the serial number of the sampler. See the FSCommAQ software manual for instructions on creating the event schedule and saving it to the USB storage device. For compatibility, USB storage devices must be formatted with the FAT or FAT32 file system.

11. SPARE PARTS and ACCESSORIES

11.1 Consumables, Replacement Parts, and Accessories

The following parts are available from Met One Instruments for maintenance, replacement, service, and upgrades. If unsure about a part, please contact the Service department and provide the serial number of all applicable SASS components. Some of these parts require technical skills or special considerations before use or installation.

Consumables

Description	Part Number
47 mm 2 micron pore-size Teflon filters (50/pkg)	460137
47 mm quartz-fiber filters (50/pkg)	460139
47 mm 1-micron pore-size nylon filters (100/pkg)	460141
Coated Mg-O denuder w/mounting ring	8382
Denuder, MgO Coated	8375
O-Ring Replacement Kit, SASS Flow Controller	80641
O-Ring Set for SASS Canister	8657
O-Ring Set for 8670 Cyclone	8658

Accessories

Description	Part Number
Temperature Sensor (-30° to +50° C)	065
Temperature Sensor Radiation Shield with Mounting	074
SCC Cyclone, SASS	8670
SASS speciation Sample Canister	8370
SASS Control Box, Touch Screen	83375
SASS Pump Box Upgrade Kit (for touch screen upgrade)	83376
47mm Filter Holder, White Ring	460128

Replaceable Parts

Description	Part Number
Sampling Head PCBA Board	3510
Flow Sensor	8424
SCC Grit Pot (Cap)	8664
Internal Temperature Sensor, SASS Head	8877
Solenoid Valve Assy (Sample Flow Line Select)	8893
Solenoid Valve Assy (SASS Pump Bypass	8894
Flow Controller Assembly	9053
Pump Box Circuit Board Stack – SuperSASS	80474
Switching 12V Power Supply, Universal Input	510636
SASS Pump Exhaust Muffler	580293
Pump Main Exhaust Muffler	580297
Inline Filter	580299
Quick Connect Adapter with Shut-Off (1/8" MPT)	580010
Quick Connect Adapter with Shut-Off, Panel Mount (1/4" Barb)	580012
Muffin Fan Motor (12V DC)	590052
15 Amp Fuse	590816
Vacuum Diaphragm Pump, 120 VAC, 60 HZ	680832
Vacuum Pump, 240 VAC, 50 HZ	82936
8A, 240V Fast-Acting Fuse	590848
Tubing, Polyethylene .170 ID X 1/4" OD (Black)	960020
Tubing, 1/4" ID X 3/8" OD, PVC With Hytrel Lining	960205

Cables

Description	Part Number
Cable, Pump Box to Control Box (Communication)	8833
Cable, Ambient Temp Sensor	8838
Cable, Sampling Head to Pump Box	8896
Cable, Pump Box Ground Cable Assembly	9035

Calibration Tools

Description	Part Number
Field Temperature Calibrator	9099
Flow Calibration Meter	SWIFT 25.0

Audit Sheet

Model:		Serial Number:	
Audit Date:		Audited By:	

Flow Audits			
Flow Reference Standard Used:	Model:	Serial No:	Calibration Date:
Temperature Standard Used:	Model:	Serial No:	Calibration Date:
Barometric Pressure Standard Used:	Model:	Serial No:	Calibration Date:

Leak Check Value:	as found:	lpm	as left:	lpm	
Ambient Temperature:	as found:	C	as left:	C	N/A
	as found:	mmHg	as left:	mmHg	
	as found:	lpm	as left:	lpm	N/A

Mechanical Audits

Fan filters clean:	as found		as left	
PM ₁₀ particle trap clean:	as found		as left	
PM ₁₀ drip jar empty:	as found		as left	
PM ₁₀ bug screen clear:	as found		as left	
PM _{2.5} particle trap clean:	as found		as left	
Pump muffler unclogged	as found		as left	



Error	Date	Time
1		
2		
3		

Error	Date	Time
4		
5		
6		

Audit Notes:
