

USER MANUAL

Serinus 30

Carbon Monoxide Analyser

Version: 3.3



acoem.com



Ecotech Pty Ltd is now part of the Acoem Group and as such, the branding of our instruments & software has also changed to 'Acoem'.

Over time we will be updating the content of all documents to reflect the Acoem branding convention.

In the interim, please note that while the cover of this document features Acoem branding, information contained within its pages still utilises the original 'Ecotech' name.

This page is intentionally blank

Table of Contents

Table of Contents.....	3
Manufacturer’s Statement	12
Notice	12
Safety Information	13
Warranty.....	15
Service & Repairs	16
Product Compliance and Approvals.....	17
Manual Revision History	18
1. Introduction.....	21
1.1 Description	21
1.2 Specifications	21
1.2.1 Measurement	21
1.2.2 Precision/Accuracy	21
1.2.3 Calibration	22
1.2.4 Power	22
1.2.5 Operating Conditions.....	22
1.2.6 Communications.....	23
1.2.7 Physical Dimensions.....	23
1.2.8 Certifications.....	23
1.3 Nomenclature	24
1.4 Background/Theory.....	25
1.4.1 Measurement Theory	25
1.4.2 Kalman Filter Theory.....	26
1.5 Instrument Description	27
1.5.1 Calibration Valve Manifold	27
1.5.2 Sample Filter Holder	28
1.5.3 CO-CO ₂ Converter	28
1.5.4 Measurement Cell	29
1.5.5 Main Controller PCA	33
1.5.6 Pneumatic Tubing	33
1.5.7 Rear Panel.....	34
1.5.8 Communications.....	35
2. Installation/Decommission.....	37
2.1 Initial Check.....	37
2.2 Installation Notes	40
2.3 Instrument Set-Up.....	41
2.3.1 Power Connections.....	41
2.3.2 Pneumatic Connections	42
2.3.3 Communications Connections	45
2.3.4 Instrument Set-Up	46
2.4 U.S. EPA Reference Set-Up.....	47
2.5 EN Type Approval Set-Up	48
2.6 Transporting/Storage	49
3. Operation.....	51

3.1	Warm-Up	51
3.2	Measurement	51
3.3	General Operation Information	52
3.3.1	Keypad & Display.....	52
3.3.2	Home Screen	54
3.4	Menus & Screens	56
3.4.1	Quick Menu	57
3.4.2	Main Menu.....	58
3.4.3	Analyser State Menu	59
3.4.4	Status Menu	60
3.4.5	Temperature Menu	61
3.4.6	Pressure & Flow Menu	62
3.4.7	Voltage Menu.....	63
3.4.8	General Settings Menu.....	64
3.4.9	Measurement Settings Menu.....	65
3.4.10	Calibration Menu	66
3.4.11	Pressure Calibration Menu.....	68
3.4.12	Flow Calibration Menu (Option).....	69
3.4.13	Service Menu.....	70
3.4.14	Diagnostics Menu	71
3.4.15	Digital Pots Menu	71
3.4.16	Internal Pump Menu (Option).....	73
3.4.17	Valve Menu	74
3.4.18	Tests Menu.....	75
3.4.19	Digital Input Test Menu.....	75
3.4.20	Digital Output Test Menu.....	76
3.4.21	Calculation Factors Menu.....	76
3.4.22	Communications Menu	78
3.4.23	Data Logging Menu	78
3.4.24	Serial Communication Menu.....	79
3.4.25	Analog Input Menu	80
3.4.26	Analog Output Menu.....	81
3.4.27	Digital Input Menu	83
3.4.28	Digital Output Menu	84
3.4.29	Network Menu (Option).....	85
3.4.30	Bluetooth Menu	87
3.4.31	Trend Display Menu	87
3.4.32	Chart	88
3.4.33	Advanced Menu	90
3.4.34	Hardware Menu	91
3.4.35	Parameter Display Menu.....	92
4.	Communications.....	93
4.1	RS232 Communication.....	93
4.2	USB Communication	94
4.3	TCP/IP Network Communication (Optional)	95
4.3.1	Reading Network Port Setup	96
4.3.2	Setting Network Port Setup	96
4.3.3	Port Forwarding on Remote Modem/Router Setup.....	97
4.3.4	Airodis Setup to Communicate with Serinus.....	98
4.4	Analog and Digital Communication	99

4.4.1	Analog Outputs	99
4.4.2	Analog Inputs	100
4.4.3	Digital Status Inputs	100
4.4.4	Digital Status Outputs	100
4.5	Logging Data	101
4.5.1	Configure Instrument Internal Logging	101
4.6	Using Airodis Software to Download Data	102
4.6.1	Connecting the Instrument to a PC	102
4.6.2	Installing Airodis	105
4.6.3	Configuring Airodis	105
4.7	Serinus Remote App/Bluetooth	111
4.7.1	Installation	111
4.7.2	Connecting to the Instrument	111
4.7.3	Instrument Control	112
4.7.4	Real-Time Plot	114
4.7.5	Download	115
4.7.6	Get Parameters	115
4.7.7	Preferences	116
5.	Calibration	119
5.1	Overview	119
5.2	Pressure Calibration	121
5.2.1	Full Pressure Calibration (Two Point Calibration)	121
5.2.2	Pressure Calibration (Ambient Only)	123
5.2.3	Pressure Calibration (Internal Pump Option Only)	123
5.3	Manual Background	125
5.4	Zero Calibration	125
5.4.1	Calibration Port	125
5.4.2	Sample Port	126
5.4.3	Background Air Port	127
5.5	Span Calibration	127
5.5.1	Calibration Port	128
5.5.2	Sample Port	129
5.5.3	Manual Instrument Gain and Offset Adjustments	129
5.6	Precision Check	130
5.7	Multipoint Precision Check	130
5.8	Flow Calibration (Internal Pump Option Only)	132
5.9	High Pressure Zero/Span Valve (Option)	133
5.9.1	Single Pressurised Calibration Option	134
5.9.2	Dual Pressurised Calibration Option	135
6.	Service	139
6.1	Additional Safety Requirements for Service Personnel	139
6.2	Maintenance Tools	139
6.3	Maintenance Schedule	141
6.4	Maintenance Procedures	142
6.4.1	Particulate Filter Replacement	142
6.4.2	Clean Chassis Fan Filter	145
6.4.3	DFU Replacement	146
6.4.4	Leak Check	146

6.4.5	CO-CO ₂ Converter Check	151
6.4.6	Sintered Filter/Orifice Replacement	152
6.4.7	Trim Pot Tuning Procedure	153
6.4.8	Clean Pneumatics	154
6.4.9	Pressure Sensor Check	154
6.5	Bootloader	155
6.5.1	Display Help Screen	155
6.5.2	Communications Port Test	155
6.5.3	Updating Firmware	155
6.5.4	Erase All Settings	156
6.5.5	Start Analyser	156
7.	Troubleshooting.....	158
7.1	Flow Fault	162
7.2	Noisy/Unstable Readings	163
7.3	Cell Temperature Failure	164
7.4	Mirror Temperature Failure.....	165
7.5	USB Memory Stick Failure.....	166
7.6	Ecotech Service Support Files	167
8.	Optional Extras.....	170
8.1	Dual Sample Filter (PN: E020100)	170
8.2	Network Port (PN: E020101).....	170
8.2.1	Hardware Setup	171
8.3	Rack Mount Kit (PN: E020116).....	171
8.4	Internal Pump (PN: E020107)	175
8.4.1	Hardware Setup	175
8.4.2	Internal Pump Additional Components	176
8.4.3	Internal Pump Removed Components	176
8.4.4	Pressure Calibration Internal Pump Option	176
8.4.5	Flow Calibration	177
8.4.6	Internal Pump Leak Check.....	177
8.4.7	Pump Control	177
8.5	Metric Fittings Kit (PN: E020122).....	177
8.6	High Pressure Zero/Span Valves	177
8.7	Trace Level Instrument (PN: E020127)	178
8.7.1	Trace Specifications.....	178
8.7.2	Measurement.....	178
8.7.3	Precision/Accuracy.....	178
8.7.4	Calibration.....	178
8.7.5	Trace setup.....	179
8.7.6	Trace Operation	179
8.7.7	Trace Default Values	180
8.7.8	Trace Calibration Guidelines	180
8.7.9	Trace Service and Maintenance	181
8.8	External CO ₂ Sensor (PN: E031014)	182
8.8.1	Introduction	182
8.8.2	Specifications	182
8.8.3	Equipment Required	183
8.8.4	Installation	183

8.8.5	Operation.....	185
8.8.6	Maintenance.....	185
8.8.7	Troubleshooting.....	185
9.	Parts List and Schematics	186
9.1	Serinus Accessories Kit	186
9.2	Maintenance Kit	186
9.3	Consumables	187
9.4	Instrument Parts List	187
9.5	Plumbing Schematic – (PN: D020005).....	192
9.6	Block Wiring Schematic – (PN: D020102).....	193
9.7	Measurement Cell – (PN: H014100).....	194
9.8	Source Timing Assembly – (PN: H014125)	195
9.9	Calibration Manifold Assembly – (PN: H010013-01).....	196
9.10	Valve Assembly – (PN: H010042)	197
9.11	High Pressure Valve Exploded View – (PN: H050043).....	198
9.12	Sample Filter Holder Assembly – (PN: H010160)	199
9.13	CO-CO ₂ Converter Assembly – (PN: H014130)	200

List of Figures

Figure 1 – Measurement Cell Theory	26
Figure 2 – Correlation Wheel	26
Figure 3 – Internal Components Diagram	27
Figure 4 – Calibration Valve Manifold	27
Figure 5 – Sample Filter Holder	28
Figure 6 – CO-CO ₂ Converter.....	28
Figure 7 – Measurement Cell	29
Figure 8 – Source Timing Assembly.....	29
Figure 9 – IR Source.....	30
Figure 10 – Gas Filter Correlation Wheel Assembly	30
Figure 11 – Detector Assembly	31
Figure 12 – Narrow-Bandpass Filter	31
Figure 13 – IR Detector	31
Figure 14 – CO Detector PCA.....	32
Figure 15 – Pressure Sensor PCA.....	32
Figure 16 – Heater and Thermistor	33
Figure 17 – Orifice and Sintered Filter	33
Figure 18 – Ecotech Tubing	33
Figure 19 – Rear Panel	34
Figure 20 – Power ON/OFF Switch	35
Figure 21 – Communication Connections	35
Figure 22 – Received Item.....	38
Figure 23 – Opening the Instrument – 1	39
Figure 24 – Opening the Instrument – 2	39
Figure 25 – Opening the Instrument – 3	39
Figure 26 – Opening the Instrument – 4	40
Figure 27 – Instrument Rear Panel.....	41
Figure 28 – Connect Power Cord.....	42

Figure 29 – Turn ON Power Switch	42
Figure 30 – Dust Plugs	43
Figure 31 – Remove Nut	43
Figure 32 – Ferrules Correct Orientation	43
Figure 33 – Replace Nut Loosely	44
Figure 34 – Insert Tube	44
Figure 35 – Tighten Nut	44
Figure 36 – Installation of USB Memory Stick.....	46
Figure 37 – Travel Screw Locations.....	46
Figure 38 – Switching the Battery ON/OFF	46
Figure 39 – Dust Plugs	49
Figure 40 – Packing Instruction	50
Figure 41 – Front Panel.....	52
Figure 42 – Home Screen.....	54
Figure 43 – Quick Menu Screen.....	57
Figure 44 – Main Menu Screen.....	58
Figure 45 – Analyser State Menu Screen	59
Figure 46 – Status Menu Screen	60
Figure 47 – Temperature Menu Screen	61
Figure 48 – Pressure & Flow Menu Screen	62
Figure 49 – Voltage Menu Screen.....	63
Figure 50 – General Settings Menu Screen.....	64
Figure 51 – Measurement Settings Menu Screen.....	65
Figure 52 – Calibration Menu Screen	66
Figure 53 – Pressure Calibration Menu Screen.....	68
Figure 54 – Flow Calibration Menu Screen	69
Figure 55 – Service Menu Screen	70
Figure 56 – Diagnostics Menu Screen.....	71
Figure 57 – Digital Pots Menu Screen	72
Figure 58 – Internal Pump Menu Screen	73
Figure 59 – Valve Menu Screen	74
Figure 60 – Tests Menu Screen.....	75
Figure 61 – Digital Input Test Menu Screen.....	75
Figure 62 – Digital Output Test Menu Screen.....	76
Figure 63 – Calculation Factors Menu Screen.....	76
Figure 64 – Communications Menu Screen	78
Figure 65 – Data Logging Menu Screen	78
Figure 66 – Serial Communication Menu Screen.....	79
Figure 67 – Analog Input Menu Screen	80
Figure 68 – Analog Output Menu Screen	81
Figure 69 – Digital Input Menu Screen	83
Figure 70 – Digital Output Menu Screen	84
Figure 71 – Network Menu Screen	85
Figure 72 – Bluetooth Menu Screen	87
Figure 73 – Trend Display Menu Screen	87
Figure 74 – Chart Screen.....	88
Figure 75 – Advance Menu Screen	90
Figure 76 – Hardware Menu Screen	91
Figure 77 – Parameter Display Menu Screen.....	92
Figure 78 – Communication Ports	93
Figure 79 – Multidrop RS232 Cable Example.....	94
Figure 80 – Example of Typical Network Setups.....	95

Figure 81 – Example of Network Menu Setup	97
Figure 82 – Port Forwarding Example	97
Figure 83 – LAN Network Set-Up (Airodis)	98
Figure 84 – WAN Network Set-Up (Airodis)	98
Figure 85 – 25 Pin Rear Panel PCA (Default Jumpers Highlighted).....	100
Figure 86 – Analog & Digital I/O Individual Pin Descriptions.....	101
Figure 87 – Installing Driver Software (Device Manager).....	102
Figure 88 – Update Driver Popup.....	103
Figure 89 – Update Driver Popup (Directory Location)	103
Figure 90 – Installing Driver Confirmation Prompt	104
Figure 91 – Successful Driver Installation.....	104
Figure 92 – Airodis Workspace Manager	105
Figure 93 – Adding a New Station	106
Figure 94 – New Station Connection.....	106
Figure 95 – Station Configuration (Channel List).....	107
Figure 96 – Error Status Notification.....	108
Figure 97 – Downloading Data	108
Figure 98 – Download Data Status	109
Figure 99 – Data Visibility.....	109
Figure 100 – Exporting Data	110
Figure 101 – Data Download Complete	110
Figure 102 – Downloading the App from Google Play Store.....	111
Figure 103 – Bluetooth Pairing Request.....	112
Figure 104 – Showing or Hiding the NumPad	113
Figure 105 – Switching Analysers	113
Figure 106 – Real-Time Plot	114
Figure 107 – Plot of Downloaded Data	115
Figure 108 – Directory Settings	116
Figure 109 – Logs Format	116
Figure 110 – Colour Theme Settings	117
Figure 111 – Example of a Calibration System	119
Figure 112 – Full Pressure Calibration Set-up	122
Figure 113 – Full Pressure Calibration Set-up (Ambient)	122
Figure 114 – Ambient Pressure Calibration Set-up	123
Figure 115 – Pressure Calibration (Internal Pump Option Only) Set-up.....	124
Figure 116 – Zero Calibration Set-up - 1.....	126
Figure 117 – Zero Calibration Set-up - 2.....	126
Figure 118 – Span Calibration Set-up - 1	128
Figure 119 – Span Calibration Set-up - 2	129
Figure 120 – Excel Graph of Multipoint Precision Check.....	132
Figure 121 – Single High Pressure Calibration Option	134
Figure 122 – Dual High Pressure Calibration Option	135
Figure 123 – Minifit Extraction Tool – (PN: T030001)	140
Figure 124 – Orifice/Sintered Filter Removal Tool – (PN: H010046).....	140
Figure 125 – Leak Test Jig – (PN: H050069).....	140
Figure 126 – Air Monitoring Test Equipment Kit (AMTEK) – Customisable.....	140
Figure 127 – Remove Kynar Nut.....	142
Figure 128 – Remove Retaining Ring.....	142
Figure 129 – Remove Filter Sealing Cap	143
Figure 130 – Particulate Filter	143
Figure 131 – Avoid to Touching Particulate Filter Paper	144
Figure 132 – Kynar Elbow Barb Fitting Direction.....	145

Figure 133 – Remove Filter Casing and Filter	145
Figure 134 – Remove Kynar Nut	146
Figure 135 – Leak Test Jig on Exhaust Port	147
Figure 136 – Connect Vacuum Source	147
Figure 137 – Kynar Blocker Nut	147
Figure 138 – Kynar Fitting Containing Orifice and Sintered Filter	152
Figure 139 – Remove Orifice and Sintered Filter	152
Figure 140 – Adjust Trim Pot	153
Figure 141 – Test Point Location	155
Figure 142 – Flow Fault Diagnostic Procedure	162
Figure 143 – Noisy Zero or Unstable Span Diagnostic Procedure	163
Figure 144 – Cell Temperature Failure Diagnostic Procedure	164
Figure 145 – Mirror Temperature Failure Diagnostic Procedure	165
Figure 146 – USB Memory Stick Failure	166
Figure 147 – USB Memory Stick File Structure	168
Figure 148 – Dual Filter Option Installed	170
Figure 149 – Separate Rack Slides	172
Figure 150 – Assemble Inner Slide on Chassis	172
Figure 151 – Rack Mount Ears Fitted to Instrument	173
Figure 152 – Attach Rack Mount Adaptors to Outer Slides	173
Figure 153 – Test Fit the Rack Slide Assembly into the Rack	174
Figure 154 – Attach Slides to Front of Rack	174
Figure 155 – Slide Clips	175
Figure 156 – External CO ₂ Sensor	182
Figure 157 – Wiring Connections - CO ₂ Probe to CO Analyser	184
Figure 158 – Example of installed CO ₂ Sensor	184

List of Tables

Table 1 – Internationally Recognised Symbols	13
Table 2 – Manual Revision History	18
Table 3 – List of Items Received	37
Table 4 – Measurements: Background and Sample Cycles	51
Table 5 – Front Panel Buttons Function	52
Table 6 – Digital Output States	84
Table 7 – New Station Setup	106
Table 8 – Maintenance Schedule	141
Table 9 – Troubleshoot List	158
Table 10 – Included Parts (Rack Mount Kit)	171
Table 11 – Internal Pump Additional Components	176
Table 12 – Internal Pump Removed Components	176
Table 13 – Trace Parts Removed	178
Table 14 – Trace Parts Added	178
Table 15 – Trace Parameter Value Changes	180
Table 16 – Maintenance Schedule	181
Table 17 – Serinus Accessories Kit – (PN: H010136)	186
Table 18 – Serinus 30 Maintenance Kit – (PN: E020202)	186
Table 19 – Serinus 30 Consumables	187
Table 20 – Spare Parts List (Main Components)	187
Table 21 – Spare Parts List (Cables)	188
Table 22 – Spare Parts List (O-rings)	189
Table 23 – Spare Parts List (Fittings)	189

Table 24 – Spare Parts List (Miscellaneous)	190
Table 25 – Spare Parts List (Shipping)	190
Table 26 – Spare Parts List (External CO ₂ Sensor)	191
Table 27 – Packet Format.....	202
Table 28 – Example: Primary Gas Request	202
Table 29 – Example: Primary Gas Response.....	203
Table 30 – Example: Primary Gas Response (Continued).....	203
Table 31 – List of Errors.....	203
Table 32 – Example: Get IEEE Response data	204
Table 33 – Advanced Protocol Parameter List	205
Table 34 – Bayern-Hessen Data	218
Table 35 – Block Check Operation.....	219
Table 36 – Status Bit Map	220
Table 37 – Failure Bit Map (Positive Logic)	221
Table 38 – Modbus Error Codes	224

List of Appendices

Appendix A. Advanced Protocol.....	202
A.1 Command Format	202
A.2 Commands	203
A.3 List of Parameters.....	205
Appendix B. EC9800 Protocol	216
B.1 Command Format	216
B.2 Commands	216
Appendix C. Bayern-Hessen Protocol	218
C.1 Command Format	218
C.2 Commands	219
Appendix D. ModBus Protocol	222
D.1 Command Format	222
D.2 Commands	223

Manufacturer's Statement

Thank you for selecting the Ecotech Serinus® 30 Carbon Monoxide Analyser.

The Serinus series is the next generation of Ecotech designed and manufactured gas analysers. The Serinus 30 will perform CO measurements over a range of 0 - 200 ppm with a lower detectable limit of 40 ppb.

This User Manual provides a complete product description including operating instructions, calibration and maintenance requirements for the Serinus® 30 Carbon Monoxide Analyser.

Reference should also be made to the relevant local standards which should be used in conjunction with this manual. Some of these standards are listed in this manual.

If, after reading this manual you have any questions or you are still unsure or unclear on any part of the Serinus® 30, please do not hesitate to contact Ecotech or your local Ecotech distributor.



Please help the environment and recycle the pages of this manual when you have finished using it.

Notice

The information contained in this manual is subject to change without notice. Ecotech reserves the right to make changes to equipment construction, design, specifications and/or procedures without notification.





Copyright © 2021. All rights reserved. Reproduction of this manual, in any form, is prohibited without the written consent of Ecotech Pty Ltd.

Safety Information

Read all the safety information in this section prior to using the equipment. To reduce the risk of personal injury caused by potential hazards, follow all safety notices and warnings in this documentation.

The following internationally recognised symbols are used on Ecotech equipment:

Table 1 – Internationally Recognised Symbols

	Protective conductor terminal	IEC 60417-5019
	Alternating current	IEC 60417-5032
	Caution, hot surface	IEC 60417-5041
	Caution, risk of danger to user and/or equipment Refer to any accompanying documents	ISO 7000-0434
	Caution, risk of electric shock	ISO 3864-5036

These symbols will also be found throughout this manual to indicate relevant safety messages.

Note: Notes are used throughout this manual to indicate additional information regarding a particular part or process.

If the equipment is used for purposes not specified by Ecotech, the protection provided by this equipment may be impaired.

Important Safety Messages

	<p>Disconnect Power Prior to Service</p> <p>Hazardous voltages exist within the instrument. Do not remove or modify any of the internal components or electrical connections whilst the mains power is ON.</p> <p>Always unplug the equipment prior to removing or replacing any components.</p>
	<p>Replacing Parts</p> <p>Replacement of any part should only be carried out by qualified personnel, using only parts specified by Ecotech, as these parts meet stringent Ecotech quality.</p>
	<p>Mains Supply Cord</p> <p>Do not replace the detachable mains supply cord with an inadequately rated cord. Any mains supply cord that is used with the instrument must comply with the safety requirements (250 V/10 A minimum requirement). A mains power cord with a protective earth conductor must be used.</p> <p>Ensure that the mains supply cord is maintained in a safe working condition.</p>
	<p>Do Not Expose Equipment to Flammable Gases</p> <p>This equipment is not intended for use in explosive environments, or conditions where flammable gases are present. The user should not expose the equipment to these conditions. Do not introduce any flammable gases into the instrument, otherwise serious accidents such as explosion or fire may result.</p>
	<p>Electromagnetic Compliance</p> <p>The instrument lid should be closed when in normal operation, to comply with EMC regulations.</p>
	<p>Means of Lifting/Carrying Instrument</p> <p>This instrument is a heavy and bulky object. Two persons should lift/carry the object, otherwise use proper lifting equipment. Proper lifting techniques should be used when moving the instrument.</p>
	<p>Internal Components</p> <p>Do not insert a rod or finger into the cooling fans, otherwise injury may result.</p> <p>Do not energise the instrument until all conductive cleaning liquids, used on internal components, are dried up.</p>

Warranty

This product has been manufactured in an ISO 9001 facility with care and attention to quality.

The product is subject to a 24-month warranty on parts and labour from date of shipment. The warranty period commences when the product is shipped from the factory. Lamps, filters and other consumable items are not covered by this warranty.

Each instrument is subjected to a vigorous testing procedure prior to despatch and will be accompanied with a parameter list and a multipoint precision check.

Service & Repairs

Our qualified and experienced technicians are available to provide fast and friendly service between the hours of 8:30 am - 5:00 pm AEST Monday to Friday. Please contact either your local distributor or Ecotech regarding any questions you have about your instrument.

Service Guidelines

This manual is designed to provide the necessary information for the setup, operation, testing, calibration, maintenance and troubleshooting of your instrument.

Should you still require support after consulting the documentation, we encourage you to contact your local distributor for support.

To contact Ecotech directly, please e-mail our Technical Support Specialist group at support@ecotech.com or to speak with someone directly:

Please dial 1300 364 946 if calling from within Australia.

Please dial +61 3 9730 7800 if calling from outside of Australia.

Please contact Ecotech and obtain a Return Material Authorisation (RMA) number before sending any equipment back to the factory. This allows us to track and schedule service work and to expedite customer service. Please include this RMA number when you return equipment, preferably both inside and outside the shipping packaging. This will ensure you receive prompt service.

When shipping instrumentation, please also include the following information:

- Name and phone number
- Company name
- Shipping address
- Quantity of items being returned
- Model number/s or a description of each item
- Serial number/s of each item (if applicable)
- A description of the problem and any fault-finding completed
- Original sales order or invoice number related to the equipment

Shipping Address:

Attention Service Department

Ecotech Pty Ltd

1492 Ferntree Gully Road,

Knoxfield, VIC, Australia 3180.

Product Compliance and Approvals

The Serinus® 30 Carbon Monoxide Analyser, as manufactured by Ecotech Pty Ltd, complies with the essential requirements of the directives listed below (including CE compliance). The respective standards have been applied:



Low Voltage Directive (LVD) Directive 2014/35/EU

EN 61010-1:2010

Safety requirements for electrical equipment, for measurement, control and laboratory use – General requirements

Electromagnetic Compatibility (EMC) Directive 2014/30/EU

EN 61326-1:2013

Electrical equipment for measurement, control and laboratory use – EMC requirements – General requirements

Radio Equipment Directive (RED) 2014/53/EU

EN 300 328 V2.1.1

Wideband transmission systems – Data transmission equipment operating in the 2.4 GHz ISM band and using wide band modulation techniques



Regulatory Compliance Mark (RCM) – Australia

AS/NZS 4268:2017

Radio equipment and systems – Short range devices – Limits and methods of measurement

**ARPANSA
Radiation Protection Standard**

Maximum Exposure Levels to Radiofrequency Fields – 3 kHz - 300 GHz – Radiation Protection Series Publicaiton No. 3: 2002

This analyser is also certified to a number of measurement standards – refer to Section 1.2.8.

Manual Revision History

Manual PN: M010027
 Current revision: 3.3
 Date released: 9 August 2021
 Description: User Manual for the Serinus® 30 Carbon Monoxide Analyser

This manual is the full user manual for the Serinus® 30 Carbon Monoxide Analyser. This manual contains all relevant information on theory, specifications, installation, operation, maintenance and calibration. Any information that cannot be found within this manual can be obtained by contacting Ecotech.

This manual uses cross reference links extensively throughout this manual. The hot keys below will greatly reduce the amount of time scrolling between references:

- You can access the links by pressing the following:
 - > CTRL + LEFT MOUSE CLICK: Move to the link location

- You can switch between links by pressing the following:
 - > ALT + LEFT ARROW KEY: Returns you to previous Link
 - > ALT + RIGHT ARROW KEY: Swaps back

Table 2 – Manual Revision History

Edition	Date	Summary
1.0	October 2008	Initial release
1.1	February 2009	Updated communications
1.2	February 2009	New maintenance procedures Updated instrument set-up Small corrections
1.3	November 2009	Updates to menu system Serinus downloader software Internal pump option Advanced parameter list
1.4	September 2010	CE conformity added Updated parts list Pressurised zero/span valve added Updates to rack mount option Updates to Serinus downloader Update to 25 pin I/O Update to network communication Analog inputs Network adapter menu

Edition	Date	Summary
2.0	July 2012	New chassis Update menu system Add Bluetooth menu Serinus Remote Android App Rack mount procedure update Analog output calibration
2.1	March 2013	Update of manual drawings, pictures and content. Format updated.
2.2	November 2013	Formatting updates Addition of Airodis installation steps
3.0	December 2014	Auto-Ranging Power Supply added Main Controller and Rear Panel PCAs changed.
3.1	April 2016	Trace option section
3.2	June 2018	Safety Information updated Product Compliance & Approvals updated
3.3	August 2021	Manual update to firmware 4.0.7 Rev. Q board. A number of changes to descriptions, procedures and menu items. Standardization of naming convection applied.

This page is intentionally blank.

1. Introduction

1.1 Description

The Ecotech Serinus 30 Carbon Monoxide Analyser uses Non-Dispersive Infrared Spectrophotometry (NDIR) technology to measure CO in ambient air, in the range of 0 - 200 ppm.

The U.S. EPA has designated the Serinus 30 Carbon Monoxide Analyser as a reference method and TÜV has designated it as an EN approved instrument.

This section will describe the specifications of the instrument as well as the main components and techniques used to obtain stable gas concentration readings.

1.2 Specifications

1.2.1 Measurement

Range

0 - 200 ppm (autoranging)

U.S. EPA designated range: Any full scale range between 0 - 50 ppm

TÜV EN certification range: 0 - 100 ppm

Lower Detectable Limit

< 0.04 ppm (40 ppb), with Kalman filter active

1.2.2 Precision/Accuracy

Precision

20 ppb or 0.1% of reading, whichever is greater

Linearity

Better than $\pm 1\%$ of full scale (0 - 50 ppm); $\pm 2\%$ of full scale (0 - 200 ppm), from best straight-line fit

Noise at Zero

< 0.02 ppm or 0.2% of concentration reading whichever is greater

Response Time

60 seconds to 95%

Sample Flow Rate

1.0 slpm

1.2.3 Calibration

Zero Drift

Temperature dependant: 0.01 ppm per °C

24 hours: < 0.1 ppm

30 days: < 0.1 ppm

Span Drift

Temperature dependant: 0.05% per °C

24 hours: 0.5% of reading or 0.1 ppm whichever is greater

30 days: 0.5% of reading or 0.1 ppm whichever is greater

1.2.4 Power

Operating Voltage

100 - 240 VAC (± 10%)

50 - 60 Hz

Overvoltage Category II

Power Consumption

190 VA (max at start-up)

115 VA (nominal)

1.2.5 Operating Conditions

Ambient Temperature: 0 - 40 °C (32 - 104 °F)

Relative Humidity: 10 - 80% (non-condensing)

Pollution Degree: 2

Sample Pressure Dependence: 5% change in pressure produces less than a 1% change in reading

Maximum altitude¹: 2000 m above sea level

¹ For higher altitude contact Ecotech for support/assistance.

1.2.6 Communications

Analog Output

Three menu selectable current or voltage analog outputs.

- Current output of 0 - 20 mA, 2 - 20 mA or 4 - 20 mA.
- Voltage output of 0 - 5 V, with menu selectable zero offset of 0 V, 0.25 V or 0.5 V.
- Voltage output of 0 - 10 V (configured using jumpers (JP3) on rear panel PCA).
- Range: User scalable min and max range for analog output to suit application.

Analog Input

- Three analog voltage inputs (0 - 5 VDC) CAT I rated.

Digital Output

- RS232 port #1: Normal digital communication.
- RS232 port #2: Multidrop port used for multiple instrument connections on a single RS232.
- USB port connection on rear panel.
- TCP/IP port (optional).
- USB memory stick (front panel) for data logging, event logging, parameter and configuration storage.
- 25 pin connector with discrete status and user control.
 - o Eight Digital Outputs, open collector max 400 mA each @ 12 VDC (max total output 2 A).
 - o Eight Digital Inputs, 0 - 5 VDC, CAT I rated.

1.2.7 Physical Dimensions

Case Dimensions

Rack length (front to rear):	622 mm (24.5")
Total length (with latch release):	662 mm (26.1")
Chassis width:	418 mm (16.5")
Front panel width:	429 mm (16.9")
Chassis height:	163 mm/Uses 4 RU (6.4")
Front panel height:	185 mm (7.3")
Weight:	20.2 kg

1.2.8 Certifications

- U.S. EPA approval (RFCA-0509-174)
- EN approval TÜV (0000040203-02)

- EN approval MCERTS (MC100166/07)
- Australian Standard (AS 3580.7.1-2011)
- Russian approval (56262-14)
- French approval (LSCQA)
- Ukraine approval (12/3/B/24/295-17)
- Chinese Pattern Approval (JJF1364-2012)
- Korean approval NIER (AACMS-2017-02)

1.3 Nomenclature

CO	This is the abbreviation for carbon monoxide.
Span	A gas sample of known composition and concentration used to calibrate/check the upper range of the instrument (carbon monoxide).
Zero	Zero calibration uses zero air (CO scrubbed ambient air) to calibrate/check the lower range of the instrument.
Background	Draws air from the background port to compensate for changes in the IR source and background interferences.
Multipoint Precision Check	A procedure to verify the linearity of the instrument.
Calibration	The process of adjusting the instrument to ensure that it is measuring the correct concentration.
Zero Drift	The change in the instrument’s response to zero air over a period of continuous unadjusted operation.
Automatic Zero	The automatic zero performs a zero check at a specified time through a 24-hour cycle which adjusts the lower limit of the instrument.
Zero Air	Is purified air in which the concentration of CO is < 50 ppb with water vapour of less than 10% RH. The internal CO-CO ₂ catalytic converter uses platinum impregnated alumina beads heated to 90 °C as a conversion agent to achieve this under ambient conditions.
External Span Source	Span gas that is delivered via an external accredited cylinder (e.g. NATA/NIST).
Sample Air	Sample air is defined as the sample before it has entered the Measurement cell, as distinguished from the exhaust air.
Exhaust Air	Exhaust air is the sample air after it has passed through the reaction/measurement/detection cell and is moving towards being expelled from the instrument.
ID and OD	These are measurements of tubing. ID is the internal diameter of tubing; OD is the outer diameter.
Multidrop	A configuration of multiple instruments connected via the same RS232 cable.
Bootloader	A program that checks whether the current firmware is valid and executes the instrument start-up. The Bootloader can be entered by pressing the ‘+’ key on the front keypad during the first 1/2 second after power ON and

	following the prompts. The Bootloader enables various low level recovery tools, including updating the firmware from a USB stick.
PCA	Printed Circuit Assembly. An electronic circuit mounted on a printed circuit board to perform a specific electronic function.
IR	Infrared. The region of the optical spectrum with a wavelength of around 4.7 microns.
Slpm	Standard litres per minute. This is the flow referenced to standard temperature and pressure conditions. For the purposes of this manual, all flows are referenced to 0 °C and 101.3 kpa (1 atm).

1.4 Background/Theory

Carbon monoxide poisoning is the most common type of fatal poisoning in many industrialised countries³. Carbon monoxide is a colourless, odourless and tasteless gas caused by the incomplete combustion of hydrocarbon fuels.

Carbon monoxide is a toxic gas to the human body, when inhaled it binds to haemoglobin, myoglobin and mitochondrial cytochrome oxidase reducing oxygen storage, transport and respiration in these organelles.

This can affect humans by causing low level symptoms such as headaches, nausea and dizziness leading up to vomiting and loss of mental/muscular control at high exposure and death in extreme cases.

1.4.1 Measurement Theory

The measurement of carbon monoxide is completed via the following principles and measurement techniques:

CO absorbs infrared radiation (IR) at a wavelength near 4.7 microns. IR radiation (at 4.7 microns) is passed through a five-metre folded path length through sample air. The strength of the signal received is proportional to the amount of CO in the sample. A band pass filter is fitted to the signal detector to ensure only light near 4.7 microns wavelength is detected.

³ Toxicology. 2002 Nov 15;180(2):139 - 50

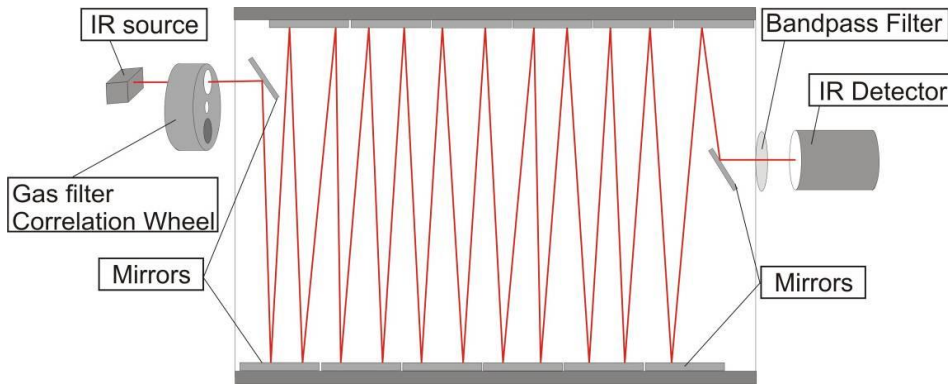

Figure 1 – Measurement Cell Theory

A gas filter correlation wheel is combined with this system. This wheel contains three parts to increase measurement accuracy: CO, N₂ and the mask.

- The CO window contains saturation (40%) of CO which acts as a reference beam – absorbing a known amount of light.
- The N₂ window, containing 100% N₂, does not absorb IR at 4.7 microns at all and is used during normal CO measurement.
- The mask totally blocks the light source and is used to determine background signals, the strength of other signals relative to each other and the background.

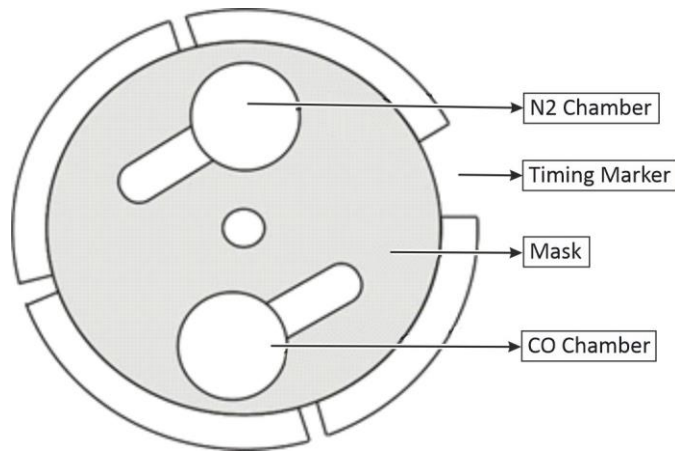

Figure 2 – Correlation Wheel

1.4.2 Kalman Filter Theory

The digital Kalman filter provides an ideal compromise between response time and noise reduction for the type of signal and noise present in ambient air analysers.

The Kalman filter enhances measurements by modifying the filter time base variable, depending on the change rate of the measured value. If the signal is changing rapidly, the instrument is allowed to respond quickly. When the signal is steady, a long integration time is used to reduce noise. The system continuously analyses the signal and uses the appropriate filtering time.

1.5 Instrument Description

The major components of the Serinus 30 are described below:

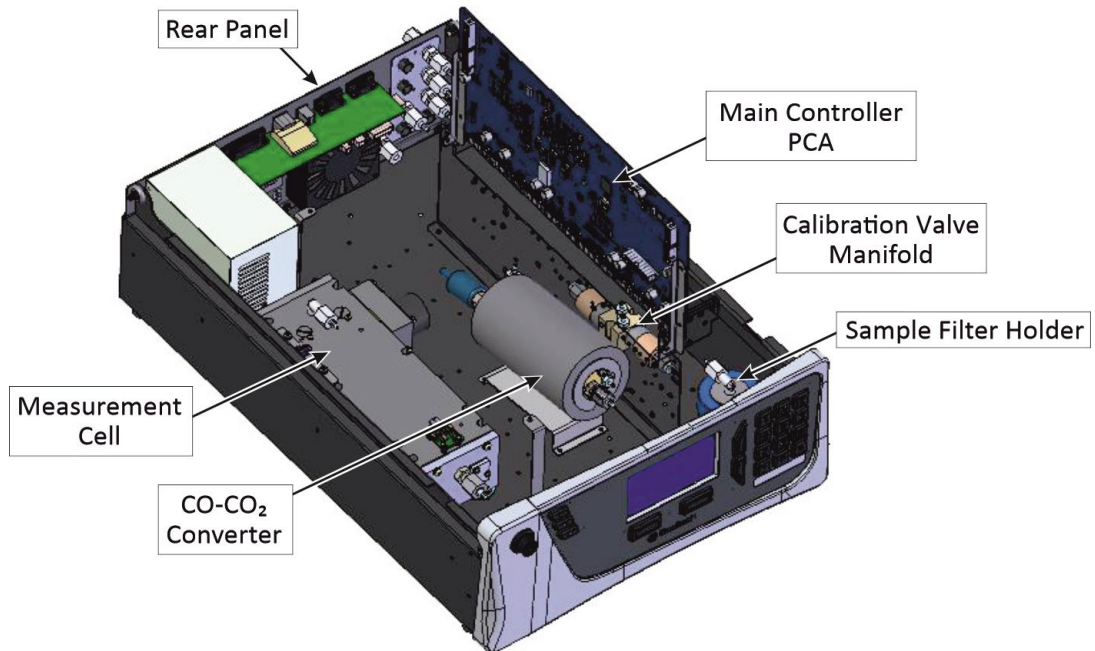

Figure 3 – Internal Components Diagram

1.5.1 Calibration Valve Manifold

Refer to Figure 3 for the location of calibration valve manifold. The calibration valve manifold switches between sample, calibration and background gas.

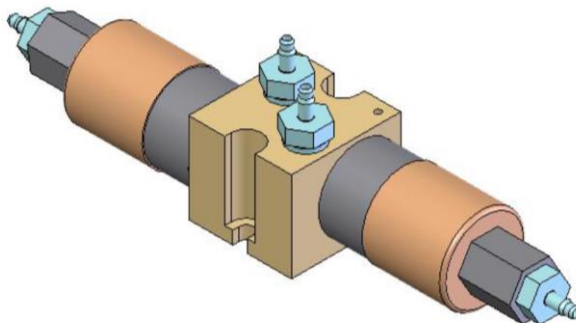

Figure 4 – Calibration Valve Manifold

1.5.2 Sample Filter Holder

Refer to Figure 3 for the location of sample filter holder. Within the sample filter holder is a particulate filter. The particulate filter is a Teflon 5-micron (μm) filter with a diameter of 47 mm. This filter prevents all particles larger than 5 μm from entering the measurement system that could interfere with sample measurement.

Note: The 5-micron filter element should be replaced on a regular basis.

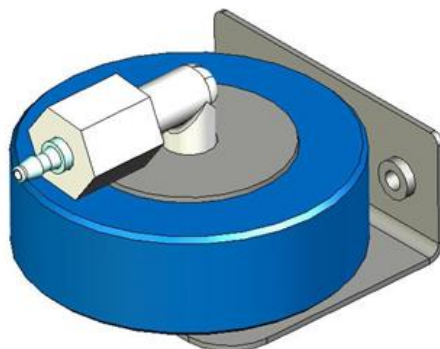

Figure 5 – Sample Filter Holder

1.5.3 CO-CO₂ Converter

Refer to Figure 3 for the location of CO-CO₂ converter. The CO-CO₂ catalytic converter uses platinum impregnated alumina beads heated to 90 °C as a conversion agent. The catalyst achieves conversion of 0 - 200 ppm CO to less than 0.1 ppm CO, even in the presence of up to 2% water.

Within the body of the CO-CO₂ converter assembly, there is a heat exchanger used to precondition the sample gas up to temperature. The sample gas is then drawn into the measurement cell.

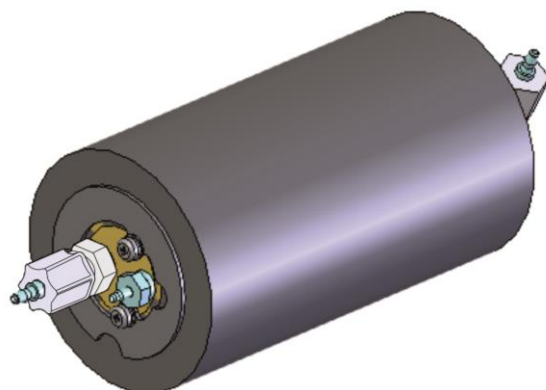

Figure 6 – CO-CO₂ Converter

1.5.4 Measurement Cell

Refer to Figure 3 for the location of measurement cell. The measurement cell consists of the following components:

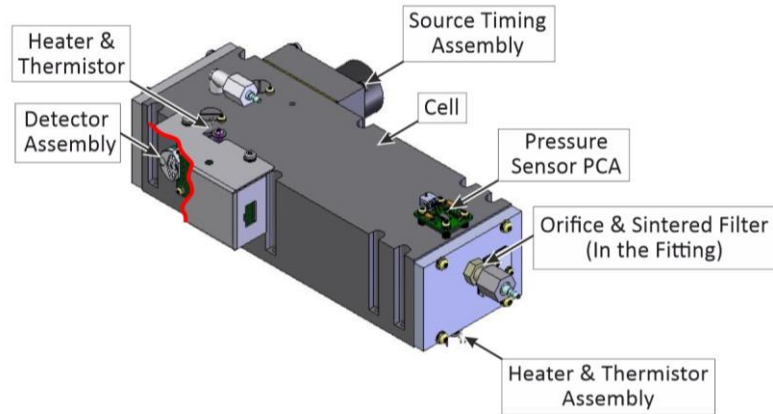

Figure 7 – Measurement Cell

1.5.4.1 Cell

Refer to Figure 7 for the location of cell. The cell contains five mirrors that form a five-meter folded path length through the cell. The sample gas is drawn through the cell filling the chamber and the IR light travels through the sample. The Cell is maintained at a set temperature based on the cell set point, default is 50 °C. The cell pressure is monitored to compensate for pressure changes.

The mirror alignment in cell assembly is critical and is factory aligned. No attempt should be made to do a field adjust to the mirrors. Doing so will void the warranty.



CAUTION

Manually adjusting any of the mirrors or trying to access the internals of this assembly may result in damage and will void the warranty.

1.5.4.2 Source Timing Assembly

Refer to Figure 7 for the location of source timing assembly. The source timing assembly consists of the following:

Refer to Section 9.8.

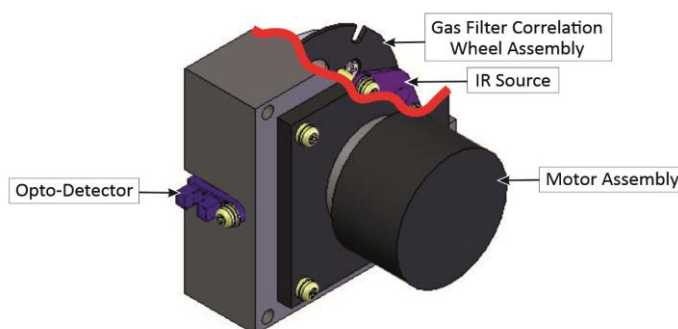

Figure 8 – Source Timing Assembly

IR Source

The IR source emits broadband infrared radiation that irradiates the filter in the correlation wheel.



Figure 9 – IR Source

Gas Filter Correlation Wheel Assembly

The gas filter correlation wheel contains three segments: a N₂ filled sapphire chamber, a CO filled sapphire chamber and a mask.

- The N₂ chamber allows all the IR radiation to pass through, which allows the radiation to be absorbed by CO in the measurement cell and readings to be recorded.
- The CO filled chamber absorbs wavelengths sensitive to CO. The sample gas (containing CO) in the measurement cell does not receive CO specific IR radiation and the only detected signals registered by the IR detector are from background sources and interference.
- The mask blocks all IR light entering the cell. This allows the intensity of the other two signals to be corrected for the detector response to no IR radiation.

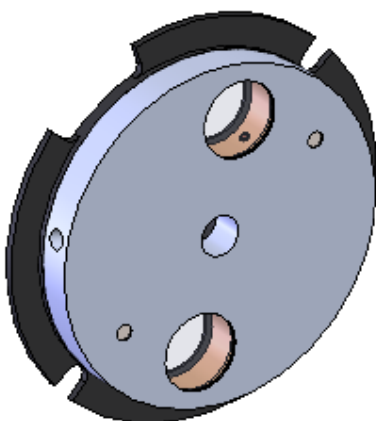

Figure 10 – Gas Filter Correlation Wheel Assembly

Opto-Detector

The correlation wheel has four tabs that act as an opto electronic switch ensuring that the main controller PCA can determine accurate timing of the wheel and the segment currently exposed to the IR radiation.

Motor Assembly

The motor that drives the correlation wheel is a 12 VDC Brushless motor.

1.5.4.3 Detector Assembly

Refer to Figure 7 for the location of detector assembly. The detector assembly consists of the following:

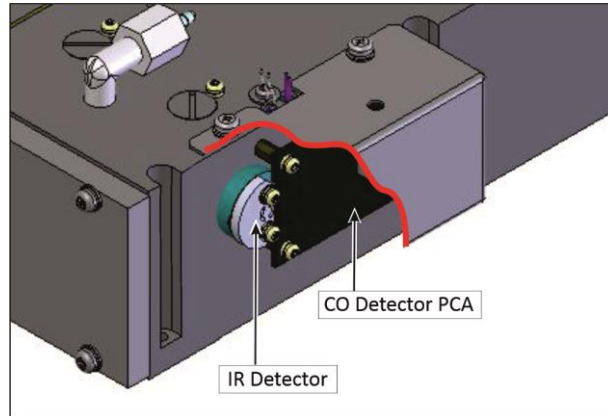

Figure 11 – Detector Assembly

Narrow-Bandpass Filter

The narrow bandpass filter allows only the CO sensitive portion of the IR radiation to pass through to the IR detector (4.7 microns) reducing noise and interference.

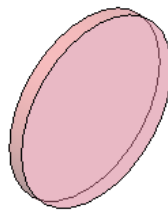

Figure 12 – Narrow-Bandpass Filter

IR Detector

The IR detector is a cooled lead selenide (PbSe) photoconductive IR detector. It creates an electrical signal when wavelengths centred at 4.7 microns reach it.

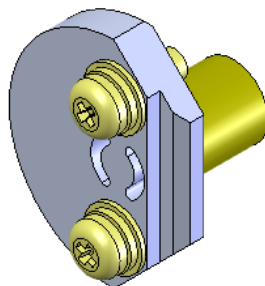

Figure 13 – IR Detector

CO Detector PCA

The detector PCA amplifies the signal from the IR detector and it includes the trim pot to adjust the detector gain.

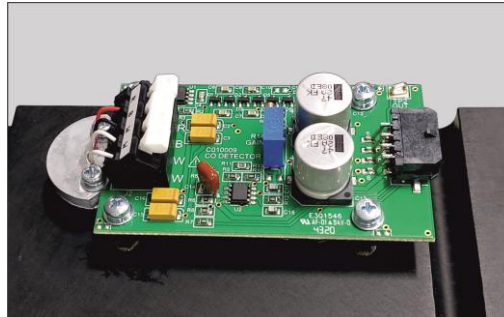

Figure 14 – CO Detector PCA

1.5.4.4 Pressure Sensor PCA

Refer to Figure 7 for the location of pressure sensor PCA. The pressure sensor PCA has an absolute-pressure transducer that is mounted on the measurement cell and sealed via a gasket. This allows the pressure sensor PCA to measure the sample air pressure in the measurement cell. This pressure reading is used to verify sample flow and correct measurement readings for pressure variations.

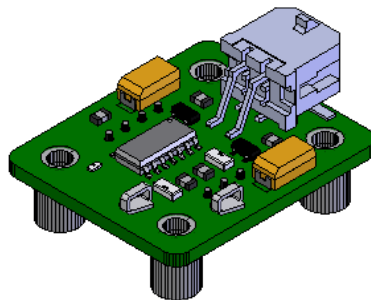

Figure 15 – Pressure Sensor PCA

1.5.4.5 Orifice and Sintered Filter

Refer to Figure 7 for the location of orifice and sintered filter. The critical orifice is made of a high precision stainless steel and sapphire, which is located Inside the Kynar fitting on the end of the measurement cell. The critical orifice is a simple device that operates at a set temperature and requires minimal maintenance, it will passively keep the volume flow rate constant at a known value.



Figure 16 – Orifice and Sintered Filter

1.5.4.6 Heater and Thermistor

Refer to Figure 7 for the location of heater and thermistor assemblies. Two heater and thermistor assemblies are used in this instrument to keep the cell temperature at a stable and constant 50 °C. They are mounted on the top of the measurement cell and below the adjustable mirror mounting plate.

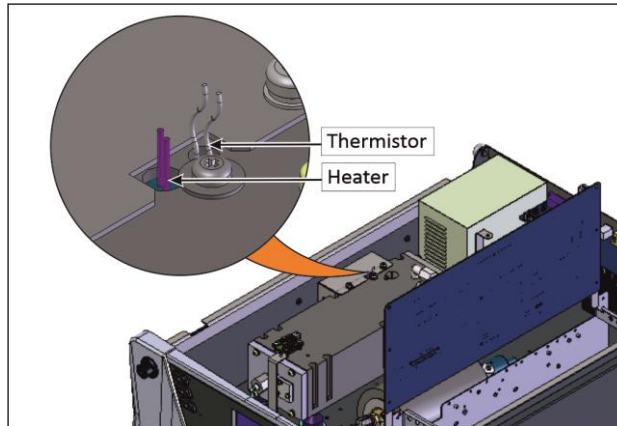

Figure 17 – Heater and Thermistor

1.5.5 Main Controller PCA

Refer to Figure 3 for the location of main controller PCA. The main controller PCA controls all the processes within the instrument. As well as the on-board microprocessor, it contains a battery backed clock, calendar analog to digital converters and many other circuits for signal processing and control. The ambient pressure and chassis temperature sensors are also located on this board. The main controller PCA is located above all other components within the instrument. It pivots on hinges to allow access to the components underneath.



CAUTION

Never place objects on top of the main controller PCA as it may result in damage.

1.5.6 Pneumatic Tubing

The pneumatic tubing inside this instrument is specially designed for use in Ecotech Serinus instruments. It has the flexibility of Silicone tubing with the added inner sheath of PVDF to prevent contamination of the sample. Care should be taken when removing and inserting the tubing into the barbed fittings.



Figure 18 – Ecotech Tubing

1.5.7 Rear Panel

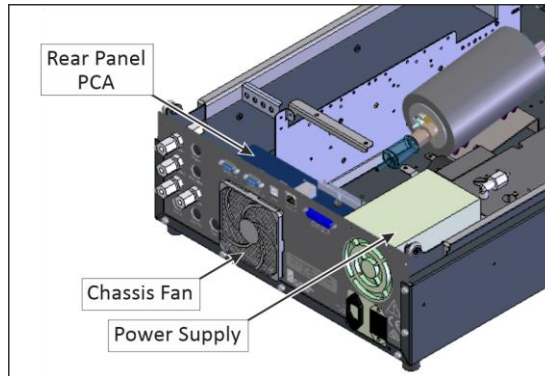

Figure 19 – Rear Panel

1.5.7.1 Rear Panel PCA

Refer to Figure 19 for the location of rear panel PCA. The rear panel PCA contains all the connections for external communications, including analog input, analog output, digital inputs, digital outputs, RS232, USB, and TCP/IP network connection (optional). Refer to Section 4.4.4 for details of all the jumper's function.

1.5.7.2 Chassis Fan

Refer to Figure 19 for the location of chassis fan. The chassis fan is assembled to the back side of the instrument to maintain the Serinus 30 temperature. Fan filter is also installed with the fan to prevent the instrument from dust.

Note: Clean the chassis fan filter on regular interval (refer to Section 6.4.2).

1.5.7.3 Power Supply

Refer to Figure 19 for the location of power supply. The power supply is a self-contained unit housed in a steel case designed to meet all the relevant safety and EMC requirements. The new revision of power supply is different to the previous revision as there is no need to set the operating voltage switch because it is autoranging.

The output of the power supply provides +12 V, +5 V, -12 V and +3.3 V to the instrument.

ON/OFF Switch

The ON/OFF switch is located on the rear panel (bottom right facing the rear of the instrument), refer to Figure 20. It is part of the power supply.



Figure 20 – Power ON/OFF Switch

1.5.8 Communications

Communication between the instrument and either a data logger, laptop or network can be performed with the following communication connections located on the rear panel (refer to Figure 21). These connections can be used for downloading data, onsite diagnostics, maintenance and firmware upgrades.

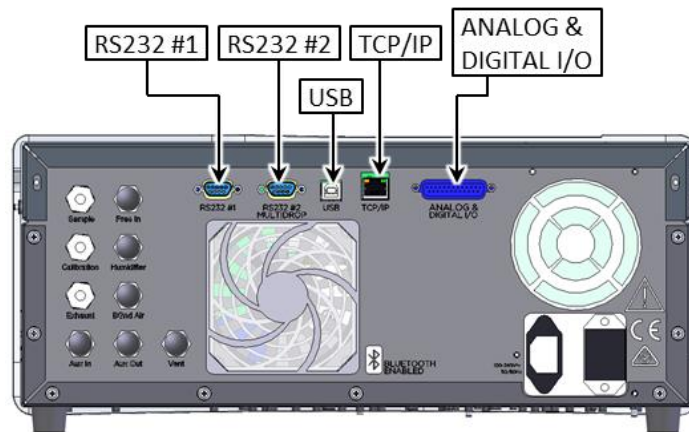

Figure 21 – Communication Connections

RS232 #1

This port is designed to be used for simple RS232 communication.

RS232 #2

This port is designed to be used for simple RS232 communication or in multidrop configuration.

USB

This port can be used for instrument communications with equipment through a standard USB port.

TCP/IP Network (optional)

This port is best used for remote access and real-time access to instruments when a network is available to connect with.

Analog & Digital I/O

The analog/digital port sends and receives analog/digital signals to other devices. These signals are commonly used to activate gas calibrators or for warning alarms.

Analog Outputs

The instrument is equipped with three user definable analog outputs. The outputs are menu selectable as voltage output 0 - 5, 0.25 - 5 or 0.5 - 5 VDC or current output 0 - 20, 2 - 20 or 4 - 20 mA. The current output can also be configured as a voltage output of 0 - 10 V, by configuring the jumpers (JP3) on the rear panel PCA.

Refer to Section 4.4 for more detail.

Analog Inputs

The instrument is also equipped with three analog voltage inputs (0 - 5 VDC CAT 1) with resolution of 15 bits plus polarity.



CAUTION

Exceeding these voltages can permanently damage the instrument and void the warranty.

Digital Status Inputs

The instrument is equipped with eight logic level inputs (0 - 5 VDC CAT 1) for the external control of zero/span calibration sequences.



CAUTION

Exceeding these voltages can permanently damage the instrument and void the warranty.

Digital Status Outputs

The instrument is equipped with eight open collector outputs, which will convey instrument status conditions and warning alarms such as no flow, sample mode, etc.



CAUTION

Exceeding 12 VDC or drawing greater than 400 mA on a single output or a total greater than 2 A across the eight outputs can permanently damage the instrument and void the warranty.

Bluetooth

This allows for remote access of the instrument to any Android device with the **Serinus Remote Application** installed on it. It uses Bluetooth to control the instrument, view parameters, download data and construct real-time graphs.

2. Installation/Decommission

2.1 Initial Check

Packaging

The Serinus® 30 is transported in packaging specifically designed to minimise the effects of shock and vibration during transportation. Ecotech recommends that the packaging be kept if there is a likelihood that the instrument is going to be relocated.

Note: The red plastic caps that seal the pneumatic connections during transport must be removed prior to operation.

Items Received

With the delivery of the Serinus 30, user will receive the following:

Table 3 – List of Items Received

Item Name	Part No.	Image
Ecotech Serinus 30 analyser	E020030	Refer to Figure 22, callout 7.
Green Ecotech Resources USB Stick	H030137-01	Refer to Figure 22, callout 10.
Manual (hardcopy optional)	M010027	-
USB Memory Stick	H030021	Refer to Figure 22, callout 9.
USB Cable	COM-1440	Refer to Figure 22, callout 8.
Keys for Slam Lock	-	Refer to Figure 22, callout 11.
Data Sheet	-	Refer to Figure 22, callout 12.
Drawing Sheet	-	Refer to Figure 22, callout 12.
Power Lead (120 V)*	C040007	Refer to Figure 22, callout 2.
Power Lead (240 V)*	C040006	Refer to Figure 22, callout 1.
	C040008	Refer to Figure 22, callout 3.
	C040009	Refer to Figure 22, callout 4.
	C040010	Refer to Figure 22, callout 5.
	C040054	Refer to Figure 22, callout 6.

*The power lead received depends on the power supply of the country (120 V or 240 V).

Note: Check that all these items have been delivered undamaged. If any item appears damaged, contact your supplier before turning the instrument ON.

Note: It is recommended to kept packaging material for transport or storage purpose.



Figure 22 – Received Item

Opening the Instrument

Check the interior of the instrument with the following steps:

1. Refer to Figure 23. Remove the thumb screws located on the rear panel.

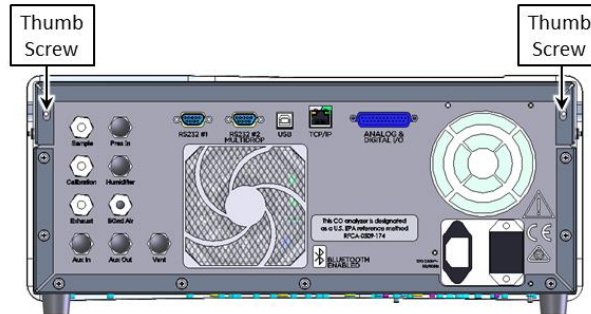

Figure 23 – Opening the Instrument – 1

2. Refer to Figure 24. Unlocked the slam lock using keys provided with instrument.



Figure 24 – Opening the Instrument – 2

3. Refer to Figure 25. Open the chassis lid latch by pressing in the slam lock located on the front panel.



Figure 25 – Opening the Instrument – 3

4. Refer to Figure 26. To completely remove the lid, slide the lid backwards until the rollers line up with the gaps in the track and lift the lid upwards to remove from the instrument.



Figure 26 – Opening the Instrument – 4

5. Check that all pneumatic and electrical connectors are connected. If not, reconnect.
6. Check for any visible and obvious damage. If damage exists contact your supplier and follow the instructions in claims for Damaged Shipments and Shipping Discrepancies at the front of this manual.

2.2 Installation Notes

When installing the instrument, the following points must be taken into account:

- The instrument should be placed in an environment with minimal dust, moisture and variation in temperature (refer to Section 2.4 and 2.5 for specific approval set-up).
- For best results the instrument should be located in a temperature and humidity-controlled environment (air-conditioned shelter). An enclosure temperature of 25 - 27 °C is optimum.
- Whether in a rack or placed on a bench, the instrument should not have anything placed on top of it or touching the case.
- Instruments should be sited with easy access to the front panel (instrument screen/USB memory stick) and to the rear panel (communication ports/pneumatic connections).
- It is recommended that the sample line be as short as possible and/or a heated manifold be used for sampling (minimising moisture condensation in the sample).
- Do not pressurise the sample line under any circumstances. Sample should be drawn through the instrument under atmospheric pressure. This should be achieved by either using the internal pump option (if installed) or an external vacuum pump connected to the exhaust port of the instrument.
- When supplying span gas, ensure the flow is approximately 1.5 slpm and excess is sufficiently vented.
- Undo the travel screws from the measurement cell as shown in the drawing supplied (refer to Section 2.3.4).
- The chassis fan on the rear panel should be kept free of any obstructions.

Note: The power ON/OFF switch is accessible from the rear of the instrument only. Install the instrument so that the ON/OFF power switch is accessible.

2.3 Instrument Set-Up

After installing the instrument, the following procedures should be followed to ready the instrument for monitoring:

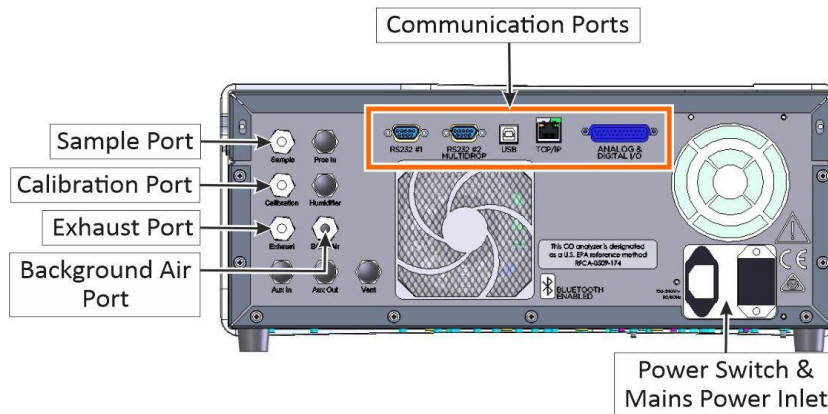

Figure 27 – Instrument Rear Panel

2.3.1 Power Connections



CAUTION

Hazardous voltages exist within the instrument. Do not remove or modify any of the internal components or electrical connections whilst the mains power is ON.



CAUTION

Always unplug the equipment prior to removing or replacing any components.



CAUTION

Do not replace the detachable mains supply cord with an inadequately rated cord. Any mains supply cord that is used with the instrument must comply with the safety requirements (250 V/10 A minimum requirement).



CAUTION

Ensure that the mains supply cord is maintained in a safe working condition.



CAUTION

When connecting the mains power to the instrument, the following must be adhered to otherwise the safety and the reliability of the instrument may be compromised.

- A three pin mains power cord with a protective earth conductor **MUST** be used.
- The mains power outlet (wall socket) must be in the range of 100 - 240 VAC, 50 - 60 Hz.

- The mains power outlet must be protected by an earth leakage protection circuit.
- Refer to Figure 28. Connect the instrument's power cord into the instrument and mains power outlet.



Figure 28 – Connect Power Cord

- Refer to Figure 29. Turn ON the power switch.

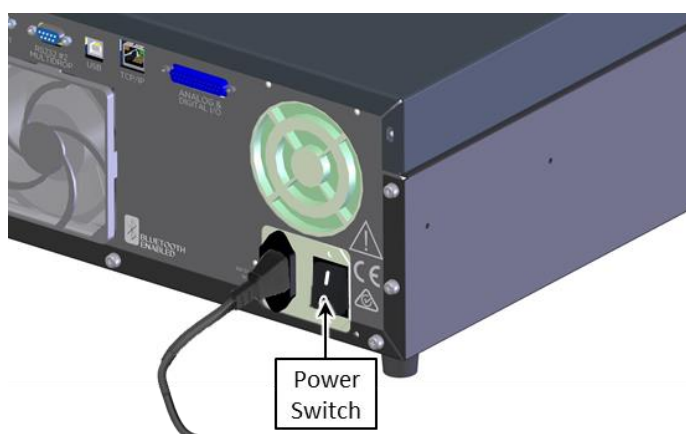

Figure 29 – Turn ON Power Switch

2.3.2 Pneumatic Connections

The Serinus 30 has four pneumatic ports on the rear panel of the instrument, the **Sample Port**, the **Calibration Port**, the **Exhaust Port** and the **Background Air Port**. All tubing and fittings used should follow the instructions below:

- Must be made of Teflon® FEP material, Kynar®, stainless steel, glass or any other suitably inert material.
- Sample line should be no more than two meters in length with 1/8" ID and 1/4" OD.
- Sample inlet pressure should not exceed 5 kPa above ambient pressure.
- Tubing must be cut squarely and any burrs removed.

Procedure

1. Refer to Figure 30. Remove all the dust plugs.

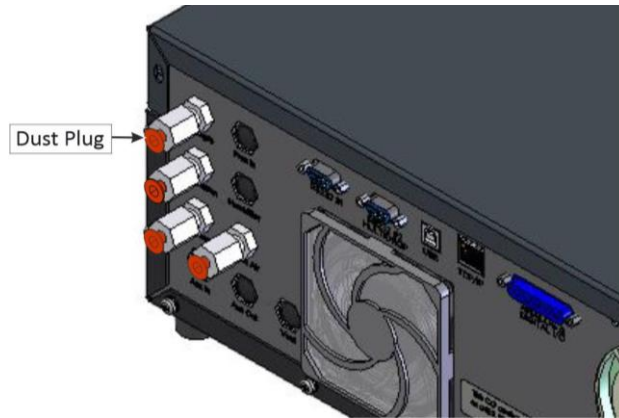

Figure 30 – Dust Plugs

2. Refer to Figure 31. Remove the sample port nut.



Figure 31 – Remove Nut

3. Inspect the ferrules inside the nut for correct orientation.



Figure 32 – Ferrules Correct Orientation

4. Replace the nut loosely, only 2 or 3 threads, on the sample port.

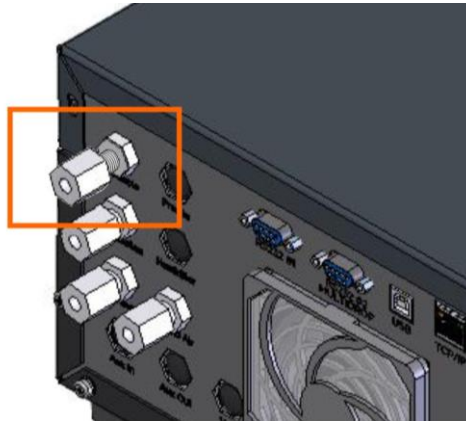

Figure 33 – Replace Nut Loosely

5. Push the tubing into the end of the nut until you hit the tube stop inside the fitting.



Figure 34 – Insert Tube

6. Tighten clockwise until finger tight.



Figure 35 – Tighten Nut

-
7. Nuts should be re-tightened when instrument reaches operating temperature.
 8. Follow the same above procedure to connect calibration, exhaust line and background air line.

Sample Port

The sample port must be connected to an ambient source of sample air. When using a sample manifold the Serinus requires at least 1.5 slpm delivered to the sample manifold (1 slpm for measurement plus approximately 50% excess).

Calibration Port

The calibration port can be connected to the span/zero sources. It is recommended that a gas dilution calibrator (Ecotech's Serinus Cal 1000, 2000 or 3000) be used with a cylinder of carbon monoxide (CO) to deliver precise concentrations of CO.

Note: All connections to this port should not exceed ambient pressure. A vent is required for excess span gas.

Exhaust Port

The exhaust port is where the measured sample, calibration gases and background air are exhausted from the instrument. The exhaust port should be connected to the vacuum pump using 1/4" OD tubing. The P030004 240 V vacuum pump (P030005, 110 V) available from Ecotech, can be used to provide the required vacuum and flow for one Serinus 30 analyser as well as two other instrument such as a Serinus 10 or Serinus 50.



CAUTION

Carbon monoxide (CO) is a toxic gas. It is recommended that exhaust air is expelled into an unoccupied area, as it contains trace levels of carbon monoxide. Furthermore, the exhaust must be a suitable distance from the sample inlet to avoid influencing the ambient measurements.

Background Air Port

The background air port is used to supply air to the CO-CO₂ converter (CO scrubber) within the instrument. This is used for backgrounds and internal zero calibration.

2.3.3 Communications Connections

There are a number of ways to communicate with the instrument, refer to Section 4 for detail.

2.3.4 Instrument Set-Up

1. Refer to Figure 36. Open the lid and make sure the USB memory stick is installed.



Figure 36 – Installation of USB Memory Stick

2. Refer to Figure 37. Remove the travel screws from the measurement cell (store in a zip lock bag within the analyser).

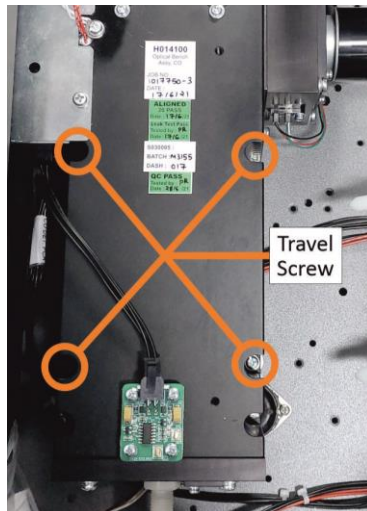

Figure 37 – Travel Screw Locations

3. Refer to Figure 38. Check that the battery switch is turned ON at the main controller PCA.

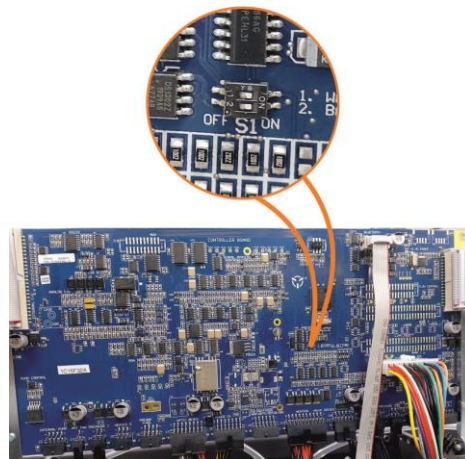

Figure 38 – Switching the Battery ON/OFF

-
4. Turn ON the instrument and allow the warm-up procedure to complete (refer to Section 3.1).
 5. Set time and date (refer to Section 3.4.8).
 6. Set the digital filter to desired setting (refer to Section 3.4.9).
 7. Set the internal data logging options (refer to Section 3.4.23).
 8. Set the analog and digital inputs and outputs settings (refer to Section 3.4.25, 3.4.26, 3.4.27 and 3.4.28).
 9. Perform a pressure sensor check (refer to Section 6.4.9).
 10. Perform a leak check (refer to Section 6.4.4).
 11. Leave the instrument to warm-up and stabilise for 4 hours.
 12. Perform a manual background (refer to Section 5.3).
 13. Perform a span calibration (refer to Section 5.5).
 14. Follow the procedure for a multipoint precision check (refer to Section 5.7).
 15. The instrument is now ready for operation.

2.4 U.S. EPA Reference Set-Up

The Serinus 30 is designated as reference method RFCA-0509-174 by the U.S. EPA (40 CFR Part 53). The Serinus 30 must be used under the following conditions to satisfy this approval:

Range

0 - 50 ppm

Ambient Temperature

20 - 30 °C

Line Voltage

105 - 125 VAC, 60 Hz

Pump

Ecotech optional internal or external pump

Filter

Factory setup to meet requirement:

Instrument Settings

If the units in the measurement menu are changed from volumetric to gravimetric (or gravimetric to volumetric) the instrument must be re-calibrated.

The following menu selections must be used:

Measurement Settings Menu

Background Interval: 24 hrs

Calibration Menu

Span Comp: Disabled

Diagnostics Menu

Press/Temp/Flow Comp: ON

Diagnostic Mode: Operate

Control loop: Enabled

The instrument must be operated and maintained in accordance with this User Manual.

The Serinus 30 analyser is designated U.S. EPA reference method with or without the following options/items:

- Internal pump
- Rack mount assembly
- Optional Ethernet Port

2.5 EN Type Approval Set-Up

The Serinus 30 has been certified to TÜV performance standards for Continuous Ambient Air Quality Monitoring Systems. The certificate number is TÜV 936/21221977/D. The Serinus 30 must be used under the following conditions to meet EN requirements:

Range

0 - 100 ppm

Ambient Temperature

0 - 30 °C

Instrument Settings

The instrument must be operated and maintained in accordance with this user manual.

The following menu selections must be used:

Measurement Settings

Background interval: 24 hrs

Calibration Menu

Span Comp: Disabled

Diagnostics Menu

Press/Temp/Flow Comp: ON
Diagnostic mode: Operate
Control Loop: Enabled

2.6 Transporting/Storage

Transporting the instrument should be done with great care. It is recommended that the packaging the instrument was delivered in should be used when transporting or storing.

When transporting or storing the instrument the following points should be followed:

1. Turn OFF the instrument and allow it to cool down.
2. Remove all connections of pneumatic pipe, power cables and communication cables from the instrument.
3. Refer to Figure 38. If storing over a long period (six months) turn the battery OFF by moving the switch (S1) on the main controller PCA.
4. Remove the instrument from the rack.
5. Refer to Figure 39. Seal each pneumatic ports with a dust plug.

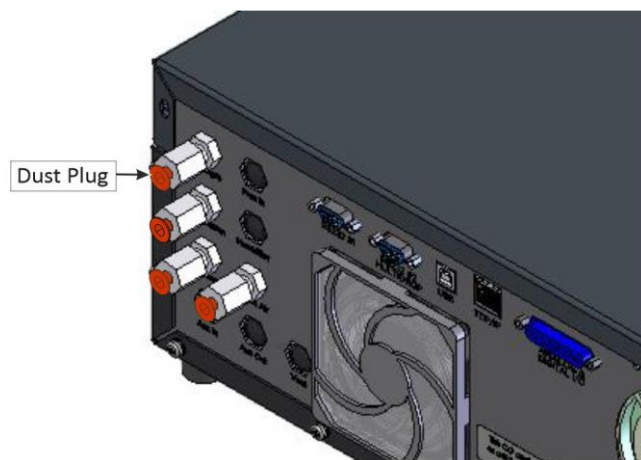

Figure 39 – Dust Plugs

6. Refer to Figure 37. If transporting the instrument, replace the travel screws.



CAUTION

Major damage to the instrument components may occur in transit if the measurement cell is not secured in place with the supplied transit screws.

7. Refer to Figure 36. Remove the USB memory stick and pack with instrument.
8. Place the instrument back into a plastic bag with desiccant packs and seal the bag (ideally the bag supplied upon delivery).

9. Refer to Figure 40. Place the instrument back into the original foam and box it was delivered in. If this is no longer available find some equivalent packaging that provides protection from damage.

Note: Ecotech recommended to use the same packing material in which instrument is delivered.

10. The instrument is now ready for long term storage or transportation.

Note: After transport or storage the instrument must be set-up and calibrated (refer to Section 2.3.4).

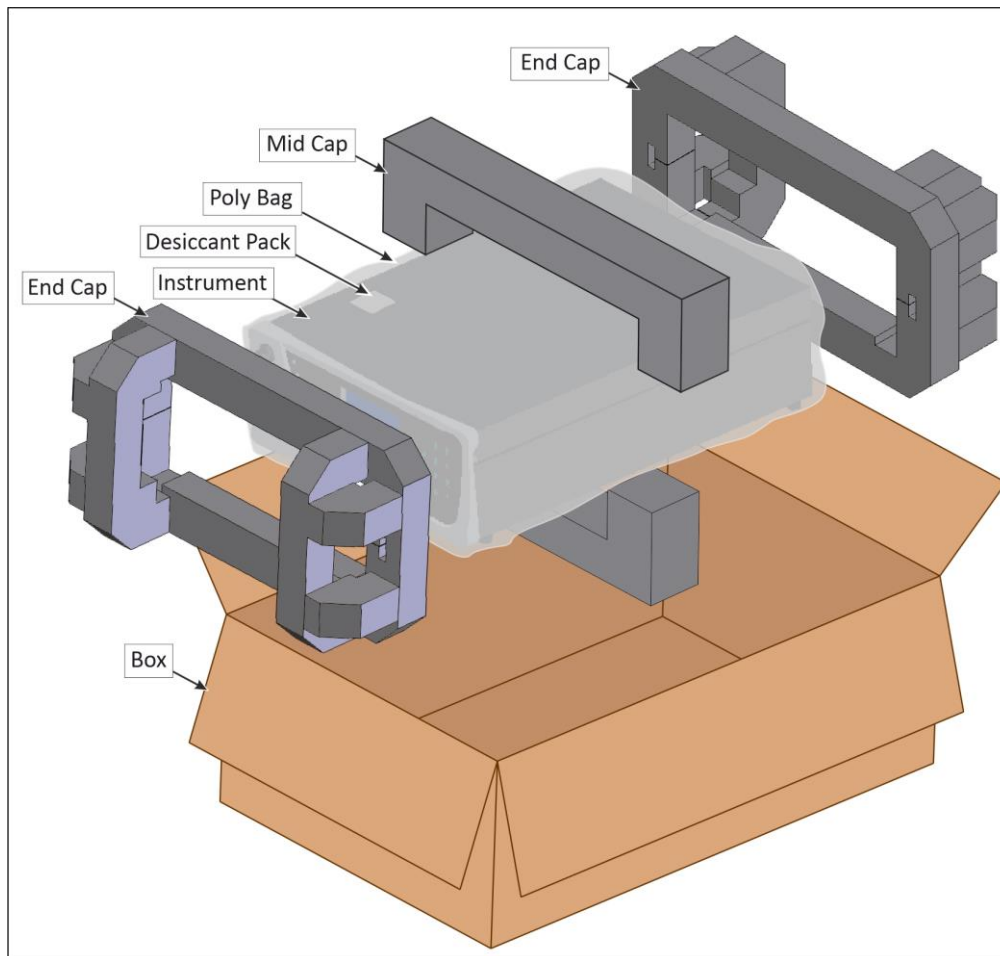

Figure 40 – Packing Instruction

3. Operation

3.1 Warm-Up

When the instrument is first turned ON it must go through a period of adjustment and calibration. No measurements are taken during this warm-up period.

The following activities occur during warm-up:

Auto Ref. Adjust

Adjusts the reference voltage and internal trim pot setting

Auto Zero Adjust

Adjusts the zero offset

Heat CO Scrubber

The instrument progressively increases the temperature of the CO scrubber until it reaches the desired temperature of 90 °C. When heating from cold, the scrubber will take approximately 20 - 30 minutes to reach desired temperature.

Cell Temperature

Waits until the cell temperature reaches at least 90% of set point.

After this warm-up has completed the instrument will immediately begin making measurements (refer to Section 3.2).

3.2 Measurement

The Serinus 30 primarily operates in the sample cycle continuously. A background is performed after warm-up, once a day (at 23:45 as default) or when the chassis temperature changes by 4 °C. It is used to measure background absorption in the cell and is subtracted from sample measurements.

Table 4 – Measurements: Background and Sample Cycles

Instrument State	Duration (minutes)	Description
Background Fill	3	Measurement cell fills with background air
Background Meas	1	Measurement of background air
CO Sample Fill	3	Measurement cell fills with sample air
CO Sample Meas	Continuous	Measurement of sample air

3.3 General Operation Information

3.3.1 Keypad & Display

The instrument is operated with the use of four sets of buttons:

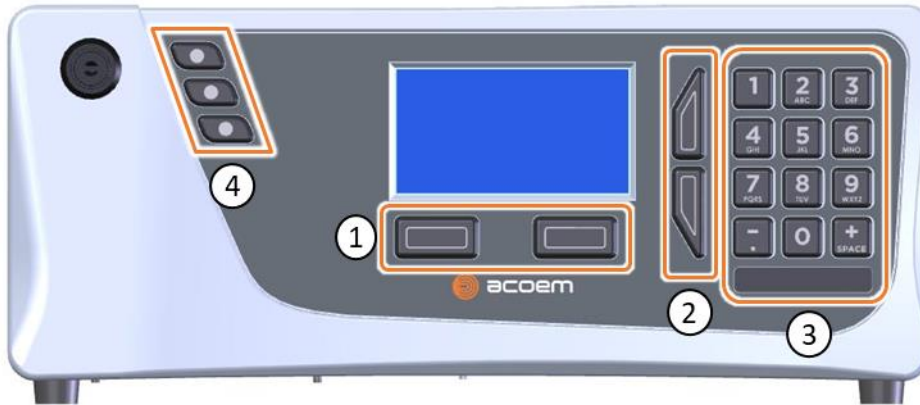

Figure 41 – Front Panel

Selection Buttons (1)

The selection buttons will perform the function specified directly above it on the screen. Generally this involves opening a menu, editing a value, accepting or cancelling an edit or starting an operation.

Scrolling Buttons (2)

The scrolling buttons allow the user to scroll up and down through menus or selection boxes. The scrolling buttons are also used to scroll side to side through editable fields such as: Dates, Times, Numbers etc.

On the home screen these buttons are used for adjusting the screen contrast. Press and hold the up button to increase contrast; press and hold the down button to decrease.

Keypad (3)

The keypad contains the numbers 0 - 9, a decimal point/minus key (.) and a space/plus key (SPACE).

In the few cases where letters can be entered, the number keys act like a telephone keypad. Every time a number key is pressed, it cycles through its choices. The up/down arrow keys scroll through all the numbers and the entire alphabet.

Table 5 – Front Panel Buttons Function

Button	Function
1	1 or space, underline
2	2, A, B, C, a, b, c
3	3, D, E, F, d, e, f
4	4, G, H, I, g, h, i

Button	Function
5	5, J, K, L, j, k, l
6	6, M, N, O, m, n, o
7	7, P, Q, R, S, p, q, r, s
8	8, T, U, V, t, u, v
9	9, W, X, Y, Z, w, x, y, z
0	0 or space, underline
(⁺ _{SPACE}) and key (⌵)	<p>When editing a floating point number:</p> <p>The key (⌵) inserts a negative sign if the editing cursor is at the start of the number and negative signs are allowed. Otherwise it moves the decimal place to the current cursor location.</p> <p>inserts a positive sign if the cursor is at the start of the number; otherwise it enters a space.</p> <p>For non-floating point numbers:</p> <p>These keys usually increment or decrement the current value by 1. When editing the month field of a date, the (⁺_{SPACE}) and (⌵) key change the month.</p>

Instrument Status Light Buttons (4)

Located in the top left corner, these lights indicate the status of the instrument:

- A red light indicates that the instrument has a major failure and is not functioning.
- An orange light indicates there is a minor problem with the instrument, but the instrument may still take measurements reliably.
- A green light indicates that the instrument is working and there are no problems.

In the case of an orange or red light illuminated go to the **Status Menu** to find which components are failing (refer to Section 3.4.4) or press the orange or red status light button to see the pop up box with a full list of current faults.

Press the green status light button at any time to close any open edit box or menu and return to the home screen.

If none of instrument status lights are ON and the keypad is backlit, this indicates that the instrument is running the bootloader. The screen will also indicate that it is in the bootloader menu.

3.3.2 Home Screen

The home screen is composed of seven parts: readings (1), error/status line (2), instrument activity line (3), selection buttons (4), time/date (5), concentration units (6) and USB status (7).

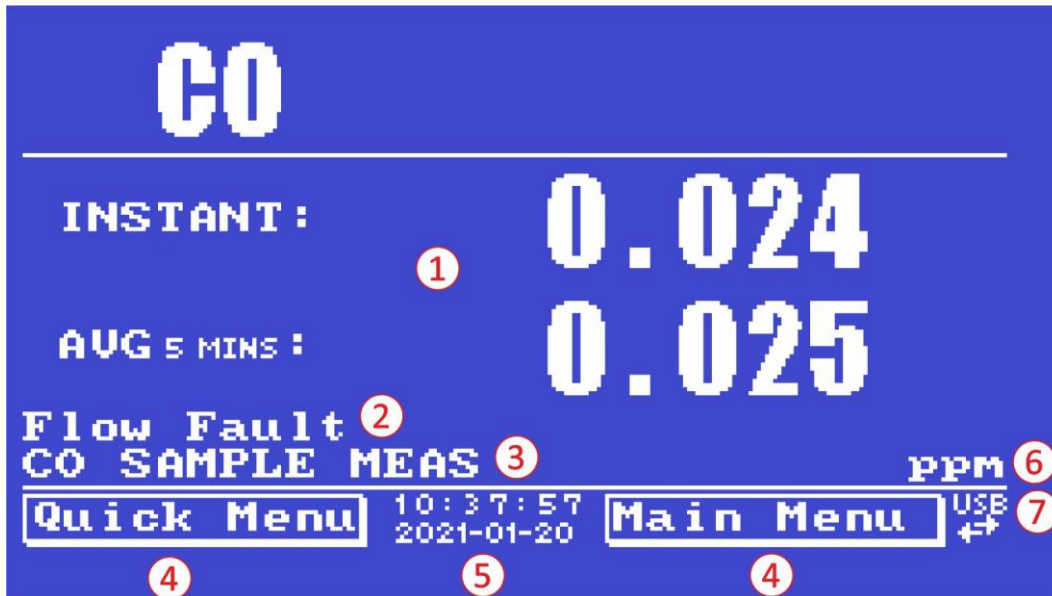

Figure 42 – Home Screen

Readings (1)

Displays the concentration being measured in real-time. The display can be configured to show just the instantaneous data or the instantaneous and average data (refer to Section 3.4.8 **Home Screen**).

Error/Status Line (2)

The error/status line provides the users with information on any problems the instrument may have. It displays the highest priority error or status condition contained in the **Status Menu** (refer to Section 3.4.4).

Instrument Activity (3)

This line shows what function the instrument is currently performing. Generally, it will show three groups of actions: Warm-up, Measurement or Calibration.

Selection Buttons (4)

These buttons are used on the home screen to enter one of two menus. The **Quick Menu** (refer to Section 3.4.1) contains all information and features necessary for scheduled maintenance. The **Main Menu** (refer to Section 3.4.2) contains all information and fields available to the users and is generally only used during initial set-up and diagnostics.

Time and Date (5)

The time and date are displayed in between the menu buttons at the bottom of the screen.

Concentration Units (6)

The instrument units are displayed in the bottom right corner of the display.

USB Detection (7)

A USB symbol will be displayed in the bottom right corner when the USB memory stick is plugged in (the USB socket is behind the front panel). If the USB symbol is not shown the USB memory stick should be inserted. Underneath, the USB symbol arrows may be displayed which indicates data transfer. The USB memory stick must not be removed whilst the arrows are visible.

Note: To safely remove the USB memory stick, navigate to the **Quick Menu** and use the **Safely Remove USB Stick** function (refer to Section 3.4.1).

3.4 Menus & Screens

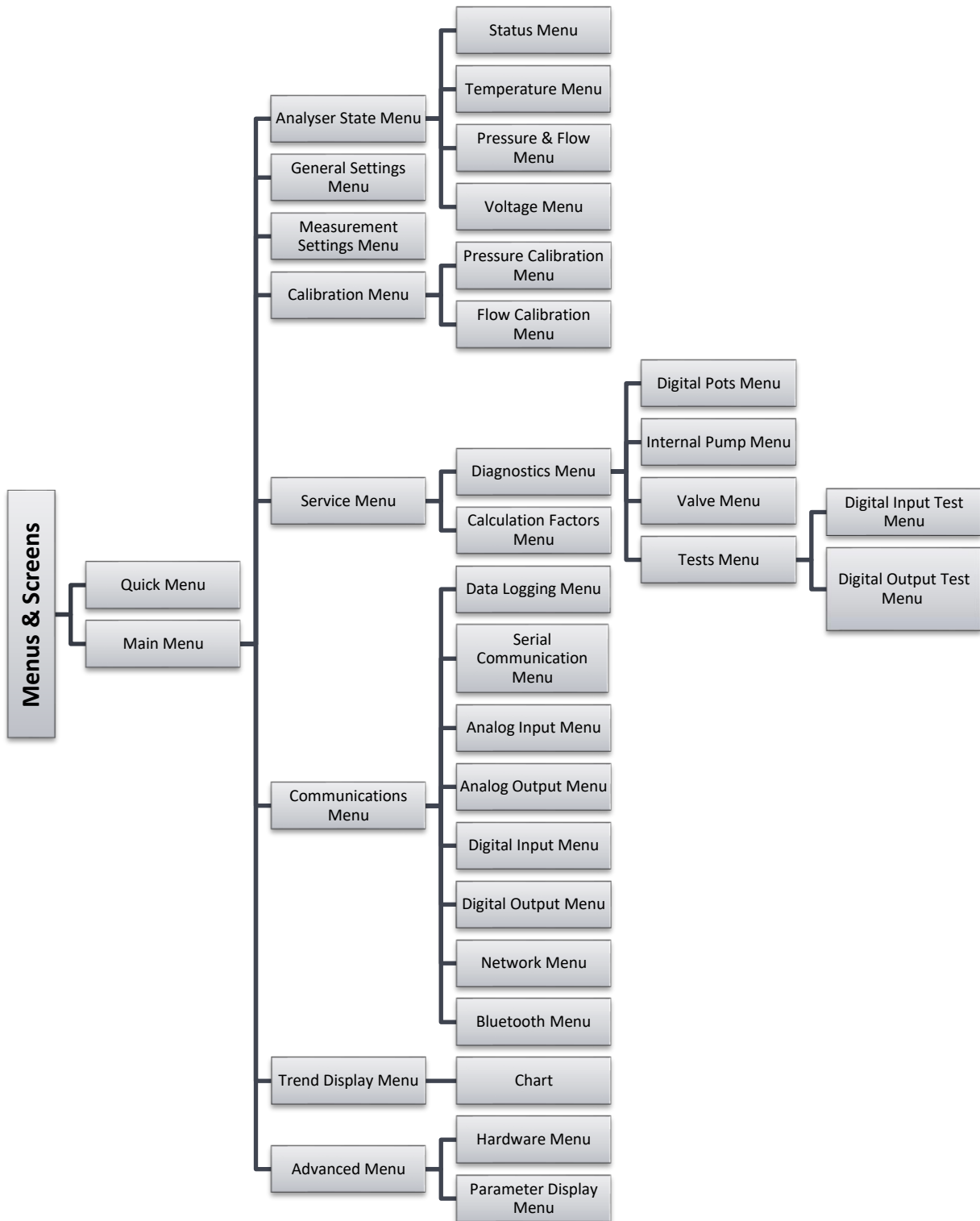

The menu system is divided into two sections selectable from the **Home Screen**: The **Quick Menu** and the **Main Menu**. The **Quick Menu** contains all information and operations necessary during scheduled maintenance visits. The **Main Menu** contains all fields that are accessible to the users. It provides information on component failures and measurement parameters as well as editable fields and test procedures.

In general, editable parameters are displayed in bold font. Non-editable information is displayed in a thin font. Some parameters may become editable based on the state of the instrument.

For example, the manual calibration type and mode can only be changed when the instrument has finished the warm-up process.

3.4.1 Quick Menu

The **Quick Menu** contains all the maintenance tools in one easy to use screen. It allows operators to perform calibrations, check important parameters and review the service history.



Figure 43 – Quick Menu Screen

Span Calibrate CO	This field is used to perform a span calibration adjustment and should be only used when a known concentration of span gas is being drawn through the measurement cell and the reading is stable. Activating the span calibrate field for a named gas will open a dialog box. Enter the concentration of the span gas that the instrument is sampling and press Accept .
Event Log	This field enters a screen with a log of all the events that the instrument has performed. These events include errors and warnings. This log is stored on the removable USB memory stick. The log is organised by month. When the user enters this screen, they will be prompted to enter the month for which they wish to view the events.
Instrument	This field allows the instrument to be set to either Online (normal instrument operation) or In Maintenance (data is flagged as invalid).
Safely Remove USB Stick	Always select this menu item before removing the USB memory stick or select the same menu item from the Service Menu (refer to Section 3.4.13). Failure to do this may cause corruption of the memory stick.

Instrument Gain	This is a multiplication factor which is used to adjust the concentration measurement to the appropriate level (set by performing a Span Calibrate CO). This should be recorded after each calibration in the station log book.
Next Service Due	A field that notifies the user when the next instrument service is due. This value is editable in the Next Service Due field of the Advanced Menu (refer to Section 3.4.31). This field is only displayed in the two weeks prior to the date displayed in this field or after the date has occurred.

3.4.2 Main Menu

There are six menus on the **Main Menu** screen.



Figure 44 – Main Menu Screen

Analyser State Menu	Refer to Section 3.4.3.
General Settings Menu	Refer to Section 3.4.8.
Measurement Settings Menu	Refer to Section 3.4.9.
Calibration Menu	Refer to Section 3.4.10.
Service Menu	Refer to Section 3.4.13.
Communications Menu	Refer to Section 3.4.22.
Trend Display Menu	Refer to Section 3.4.31.

3.4.3 Analyser State Menu

Main Menu → Analyser State Menu

This displays the status of various parameters that affect instrument measurements.

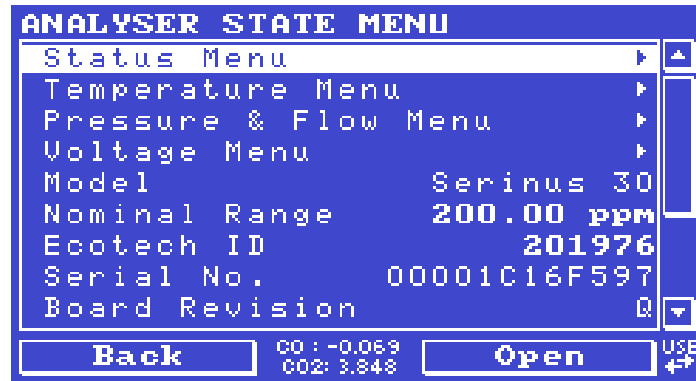

Figure 45 – Analyser State Menu Screen

Status Menu	Refer to Section 3.4.4.
Temperature Menu	Refer to Section 3.4.5.
Pressure & Flow Menu	Refer to Section 3.4.6.
Voltage Menu	Refer to Section 3.4.7.
Model	This field will display the instrument model (e.g. Serinus 30).
Nominal Range	The measurement range of the instrument.
Ecotech ID	The Ecotech ID number.
Serial No.	The main controller PCA serial number.
Board Revision	The main controller PCA version.
Firmware Ver.	This field displays the firmware version currently in use on this instrument. This can be important when performing diagnostics and reporting back to the manufacturer.
Power Failure	This field displays the time and date of the last power failure or when power was disconnected from the instrument.

3.4.4 Status Menu

Main Menu → Analyser State Menu → Status Menu

The Status Menu presents a list of the current Pass/Fail status of the main components. During warm-up, the status of some parameters will be a dashed line.



Figure 46 – Status Menu Screen

Event Log	This field enters a screen with a log of all the events that the instrument has performed. These events include errors and warnings. This log is stored on the USB memory stick. The log is organised by month. When the user enters this screen they will be prompted to enter the month for which they wish to view events.
Show Error List	This field allows the user to display the list of current errors and warnings on the screen.
Next Service Due	This field is visible with the next service due date if the service is due within the next two weeks.
Maintenance Mode	Error if the system is “In Maintenance” (refer to Section 3.4.13).
+5V Supply	Pass if the +5 V power supply is within the acceptable range.
+12V Supply	Pass if the +12 V power supply is within the acceptable range.
+Analog Supply	Pass if the analog power supply is within the acceptable range (+12 V).
-Analog Supply	Pass if the analog power supply is within the acceptable range (-12 V).
A2D	Fail only if a problem is detected with the analog to digital conversion.
Cell Temp.	Pass if the cell heater temperature is within $\pm 10\%$ of the heater set point.
CO Scrubber Temp.	Pass if the CO scrubber heater temperature is within $\pm 10\%$ of 90 °C.
Mirror Temp.	Pass if the mirror heater temperature is within $\pm 10\%$ of set point.
Lamp/Source	Fail if the reference voltage is less than 0.5 V and the input pot is over 250, which can be caused by the IR source failing.
Correlation Wheel	Fail if the correlation wheel is not functioning.
Ref Voltage	Checks that the reference voltage is within acceptable limits 3.6 - 4.4 V.
IR Source	Checks that the IR source voltage is 5 ± 0.5 V.
System Power	Pass if the system has an adequate electrical supply.

Diagnostic Mode	Error if the electronics are in Diagnostic Mode (refer to Section 3.4.14).
Diagnostic PTF Comp	Error if the Pres/Temp/Flow Comp. is disabled (refer to Section 3.4.14).
Diagnostic Control	Error if the control loop is disabled (refer to Section 3.4.14).
Valve Manual Control	Error if the valves have been placed in manual control mode (refer to Section 3.4.17).
CO Conc. V Saturated	Indicates if the voltage of the concentration during measurement is within the limits of the analog to digital converter (-0.26 V to 3.29 V).
Bkgnd Conc. V Saturated	Indicates if the voltage of the concentration during background measurement is within the limits of the analog to digital converter (-0.26 V to 3.29 V).
Pressure Calibration	Error if the user is performing a pressure calibration.
Flow Calibration [Internal Pump Option]	Error if the user is performing a flow calibration.
Flow Fault	Ok when the instrument has acceptable sample flow based on the difference between cell and ambient pressures. With the internal pump option this fault is monitored by a flow sensor.
Cell Press > Ambient	This error occurs when the pressure inside the instrument exceeds the ambient pressure.
Flow Block Temp. [Internal Pump Option]	Pass if the flow block temperature is within 10% of the heater set point (to keep a constant accurate flow).
Chassis Temp.	Pass if the chassis temperature is within the acceptable limits (0 - 50 °C).
USB Stick Disconnected	Detects whether a USB memory stick is plugged into the front USB port.
Instrument Warmup	Ok once the instrument is out of warm-up status.
Backgrounds Disabled	Ok if backgrounds is enabled.

3.4.5 Temperature Menu

Main Menu → Analyser State Menu → Temperature Menu

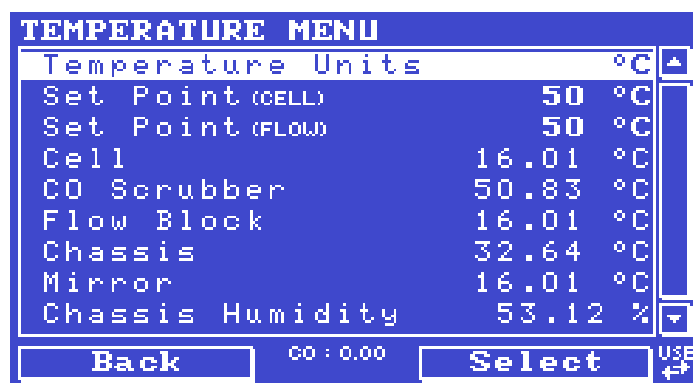

Figure 47 – Temperature Menu Screen

Temperature Units	The current temperature units of the instrument (Celsius, Fahrenheit or Kelvin).
Set Point (CELL)	The temperature set point of the measurement cell. The factory default is 50 °C.
Set Point (FLOW) [Internal Pump Option]	The temperature set point of the flow block heater. The factory default is 50 °C.
Cell	Displays current temperature of the measurement cell.
CO Scrubber	Displays current temperature of the CO Scrubber.
Flow Block [Internal Pump Option]	Displays the current temperature of the flow block.
Chassis	Displays the temperature of air inside the chassis, measured on the main controller PCA.
Mirror	Displays the temperature of the end-cap mirror plate on the measurement cell.
Chassis Humidity	Displays the humidity percentage of air inside the chassis, measured on the main controller PCA board.

3.4.6 Pressure & Flow Menu

Main Menu → Analyser State Menu → Pressure & Flow Menu

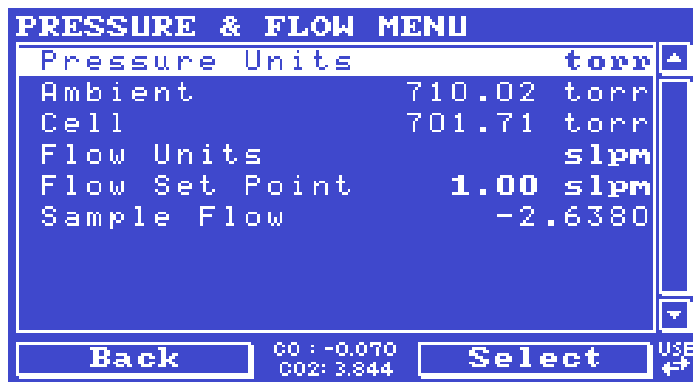

Figure 48 – Pressure & Flow Menu Screen

Pressure Units	Select the units that the pressure will be displayed in (torr, PSI, mBar, ATM or kPa).
Ambient	Current ambient pressure.
Cell	Current pressure within the measurement cell.
Flow Units	Select the units that the sample flow will be displayed in (slpm or L/min).
Flow Set Point [Internal Pump Option]	The desired sample flow.
Sample Flow	Indicates the gas flow through the sample port of the instrument. The value should be around 1.0 slpm. If there is an error with the sample flow, it will read 0.00 slpm.

3.4.7 Voltage Menu

Main Menu → Analyser State Menu → Voltage Menu

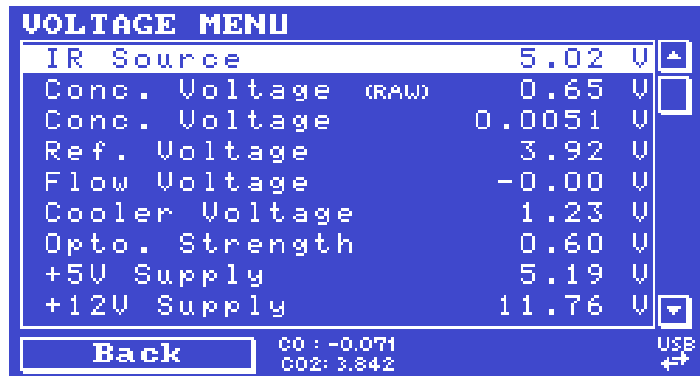

Figure 49 – Voltage Menu Screen

IR Source	The drive voltage of the IR source 5 V ± 0.5 V.
Conc. Voltage (RAW)	Voltage from the sensor proportional to the detected signal from the measurement cell. This voltage represents the actual measurement of gas.
Conc. Voltage	Displays the detector voltage after PGA scaling.
Ref. Voltage	The reference voltage is a measure of the IR source intensity.
Flow Voltage [Internal Pump Option]	The current voltage measured from the flow block PCA.
Cooler Voltage	Voltage of the peltier cooler within the IR detector (~1.25 V).
Opto. Strength	The measurement of the signal strength coming from the opto-detector on the correlation wheel.
+5V Supply	+5 V power supply.
+12V Supply	+12 V power supply.
+Analog Supply	+12 V (primary) power supply. The value should be within ± 2 V.
-Analog Supply	-12 V (primary) power supply. The value should be within ± 2 V.

3.4.8 General Settings Menu

Main Menu → General Settings Menu

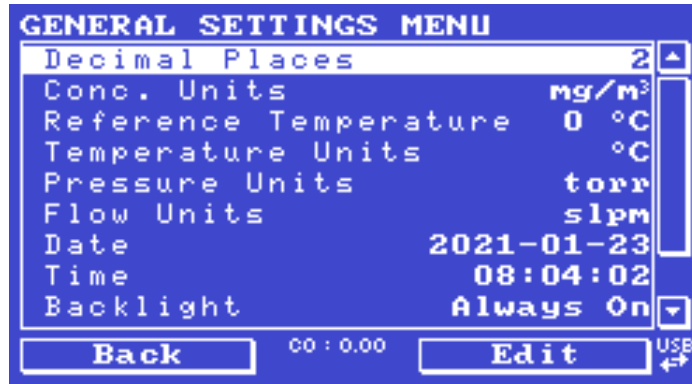

Figure 50 – General Settings Menu Screen

Decimal Places	Select the number of decimal places (0 - 5) used for the concentration displayed on the home screen.
Conc. Units	Sets the concentration units (ppm, ppb, ppt, mg/m3, µg/m3 or ng/m3).
Reference Temperature [Gravimetric Units]	This option only appears if concentration units are set to gravimetric (mg/m3, µg/m3 or ng/m3). Select either 0 °C, 20 °C or 25 °C . This sets the standard temperature used from conversion for measured volumetric values.
Temperature Units	Select the units that temperature will be displayed in (Celsius, Fahrenheit or Kelvin).
Pressure Units	Select the units that the pressure will be displayed in (torr, PSI, mBar, ATM or kPa).
Flow Units	Select the units that the sample flow will be displayed in (slpm or L/min).
Date	Displays the current date and allows users to edit if required.
Time	Displays the current time and allows users to edit if required.
Backlight	Select the length of time the screen and keypad backlight remain ON after a button press. The setting Always Off means the backlight never turns ON; the setting Always On means the backlight never turns OFF and the setting Daytime means the backlight will turn ON from 7 am to 7 pm or 30 minutes after any operation.
Home Screen	This field allows the user to display concentrations on the Home Screen in two formats. The first is Inst. only which displays only the instantaneous concentration reading, the second is Inst & Avg which displays both instantaneous and average concentration on the Home Screen . The average is measured over the time period set in Measurement Settings Menu (refer to Section 3.4.9).
Char 0 has Slash	When enabled, the instrument will display the zero character with a slash (0) to differentiate it from a capital 'O'.

3.4.9 Measurement Settings Menu

Main Menu → Measurement Settings Menu

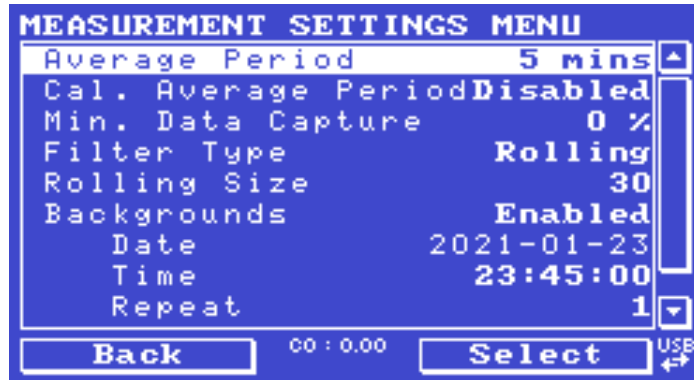

Figure 51 – Measurement Settings Menu Screen

Average Period	Set the time period over which the average will be calculated: Minutes (1, 2, 3, 4, 5, 6, 10, 12, 15, 20 or 30) or hours (1, 2, 4, 6, 8, 12 or 24) or rolling hourly averages over the last (4 or 8) hours.
Cal. Average Period	When Enabled can set the time period over which the calibration average will be calculated when the system is in Cal. Mode SPAN or ZERO: Minutes (1, 2, 3, 4, 5, 6, 10, 12, 15, 20 or 30) or hours (1, 2, 4, 6, 8, 12 or 24) or rolling hourly averages over the last (4 or 8) hours. Default is Disabled.
Min. Data Capture	Controls how much of the previous time period needs to be included before the average yields a number. The default is 0%, which reflects past behaviour of the instrument: turning on a machine with 15 minute averaging any time between 1:01 - 1:14 with a setting of 0% would produce ##### until 1:15 (because by 1:15, there was at least 1 valid measurement to construct the average from). However, a setting of 100% would mean the value stayed ##### until 1:30 (because there needs to be a complete 15 minutes worth of measurements to construct the average from).
Filter Type	Sets the type of digital filter used (None, Kalman, 10 sec, 30 sec, 60 sec, 90 sec, 300 sec or Rolling). The Kalman filter is the factory default setting and must be used when using the instrument as a U.S. EPA equivalent method or to comply with EN certification. The Kalman filter gives the best overall performance for this instrument.
Rolling Size [Rolling Filter]	Sets the number of measurements included in the rolling average. Only available if the Filter Type is set to Rolling .
Backgrounds	The default setting is enabled. When enabled it allows the user to edit the background interval via the following fields Time, Repeat and Units . When any of the backgrounds fields are edited the instrument will automatically calculate the date and time the next background is due to run and display under each relevant field.
Date [Backgrounds]	Displays the date that the next background is due to run.

Time [Backgrounds]	Edit and display the time that the next background will run. The time is set using a 24-hour clock.
Repeat [Backgrounds]	Defines an interval value for the repeat of the background based on the Units selected. This field indicates the delay period; once the specified amount of time has lapsed the background will automatically run again. The user can edit this field but some restrictions apply depending on the Units selected. Default is "1".
Units [Backgrounds]	This is where the user can define the type of units for the Repeat delay period. For example: A Repeat of "1" and Units of "Days" means that a calibration will automatically run every day at the defined time. Default is "Days".

3.4.10 Calibration Menu

Main Menu → Calibration Menu

Calibrating the instrument should be done with care (refer to Section 5 before using these menus).

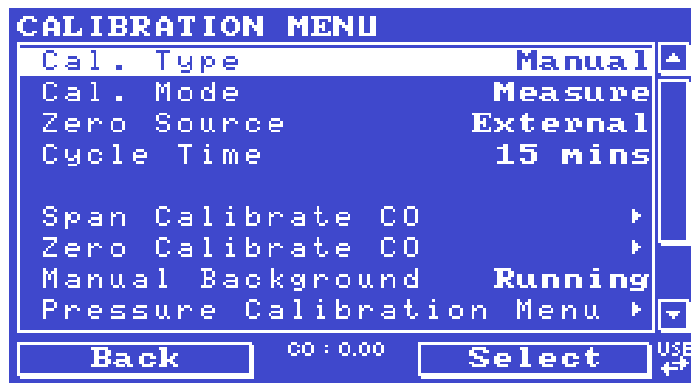

Figure 52 – Calibration Menu Screen

Cal. Type	<p>Depending on the selection in this field, a number of extra menu items will be displayed. These are separately documented in Manual Mode (refer to Section 3.4.10.1) and Timed Mode (refer to Section 3.4.10.2). Select the Cal. Type field and select either Timed or Manual. Timed mode is an automatic calibration controlled by the:</p> <ul style="list-style-type: none"> ▪ Interval between cycles ▪ Length of each calibration cycle ▪ Time when the calibration will begin ▪ Check only or automatic compensation <p>Timed calibration with span compensation enabled does not fulfil U.S. EPA approval.</p> <p>Manual mode allows the user to choose the type of calibration they wish to perform and will open the appropriate valves in preparation for the user to perform a manual calibration. The setup used will depend on the Cal. Mode selected. Manual mode is set as default.</p>
------------------	---

Zero Source	Select whether the instrument will sample from the external calibration port or from the internal zero source when zero gas is requested.
Cycle Time	The duration of each Cal. Mode (span and zero) when performing Cycle Mode (refer to Section 3.4.10.1) or Cal. Type is set to Timed . (refer to Section 3.4.10.2)
Span Calibrate CO	This field is used to perform a span calibration and should be only used when a known concentration of span gas is running through the measurement cell and the reading is stable. Activating the span calibrate field for a named gas will open a dialog box. Enter the concentration of the span gas that the instrument is sampling and press Accept .
Zero Calibrate CO	This command is used to correct the zero calibration setting. This option should be used only when zero gas is running through the measurement cell (refer to Section 5.4 before using this command).
Manual Background	Immediately perform a background.
Pressure Calibration Menu	Refer to Section 3.4.11.
Flow Calibration Menu [Internal Pump Option]	Refer to Section 3.4.12.
Pressure CO	This field displays the cell pressure measured during the last calibration.
Temperature	Cell temperature when the last span calibration was performed.

3.4.10.1 Manual Mode

These items appear in the **Calibration Menu** when **Cal. Type** is set to **Manual**.

Cal. Mode	<p>When calibration type is set to Manual the instruments operational mode can be chosen from the following:</p> <p>Measure: Is the normal measurement through the sample port.</p> <p>Zero: This mode will take air through the calibration port so that a zero calibration can be performed. Data is flagged as zero data.</p> <p>Span: This mode will take air through the calibration port so that a span calibration can be performed. Data is flagged as span data.</p> <p>Cycle: Performs a zero and a span calibration mode and returns to measure mode. The length of time spent measuring each calibration mode is set in Cycle Time (refer to Section 3.4.10).</p> <p>While the instrument is still in the warm-up period (refer to Section 3.1) the Cal. Mode cannot be changed from Measure mode.</p>
------------------	--

3.4.10.2 Timed Mode

These items appear in the **Calibration Menu** when **Cal. Type** is set to **Timed**.

Date	Enter the date for the next calibration to start.
Time	Enter the time that calibration will be performed. The time is set using a 24-hour clock.
Repeat	The calibration will automatically run again after the specified amount of time. This field specifies the delay period (from 1 - 20,000 units, as specified below).
Units	This is where the user can define the type of units for the Repeat delay period. For example: A Repeat of “3” and units of “Days” means that a calibration will automatically be performed every three days.
Span Compensation	When Enabled the instrument will automatically perform a Span Calibrate CO at the end of the Cycle Time and adjust the gain based on the Span Level . When Disabled it will do a precision check only, no adjustment is made. Timed calibration with span compensation enabled does not fulfil U.S. EPA approval or EN certification.
Span Level	Enter the concentration of span gas expected. Used when the Span Compensation is Enabled .

3.4.11 Pressure Calibration Menu

Main Menu → Calibration Menu → Pressure Calibration Menu

Entering this menu will set the valves to the pressure calibration configuration; leaving the menu will restore the valves to normal operation (refer to Section 5.2).

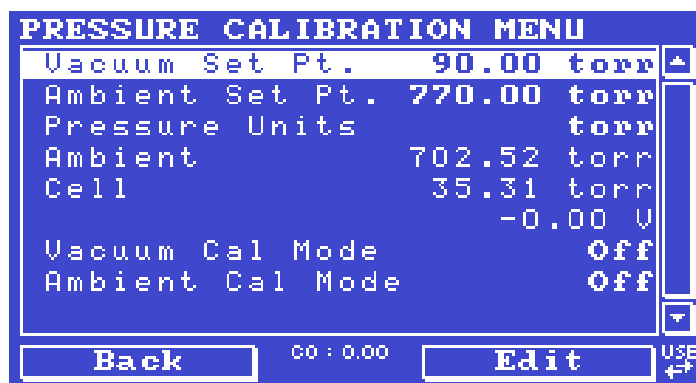

Figure 53 – Pressure Calibration Menu Screen

Vacuum Set Pt.	The zero point for the calibration. Activating this item will open a dialog box of instructions.
Ambient Set Pt.	The high point for the calibration. Activating this item will open a dialog box of instructions.
Pressure Units	Select the units that the pressure will be displayed in (torr, PSI, mBar, ATM or kPa).

Ambient	The current ambient pressure.
Cell	The current pressure in the measurement cell.
	The current measurement cell pressure displayed as a raw voltage.
Vacuum Cal Mode	Defaults to Off. When turned On, the valves will be set to the same state as during a Vacuum Set Pt. adjustment, but there is no adjustment. Used for checking the accuracy of the vacuum pressure calibration. There are no dialog boxes or prompts, so the user needs to follow similar steps and precautions as during Vacuum Set Pt.
Ambient Cal Mode	Defaults to OFF. Similar to Vacuum Cal Mode , except the valves are set to check the ambient calibration.

3.4.12 Flow Calibration Menu (Option)

Main Menu → Calibration Menu → Flow Calibration Menu

This menu only appears when the internal pump option is installed. Refer to Section 5.8 for the calibration procedure. Setting the **Pump Control** to **MANUAL** will automatically disable the valve sequencing ready for flow calibration.



Figure 54 – Flow Calibration Menu Screen

Flow Set Point	The desired sample flow target.
Cell	The current pressure in the measurement cell.
Cal. Point	The flow at which the last flow calibration was performed. If Pump Control is set to MANUAL and Internal Pump is ON , this field can be edited to calibrate the current flow against a reference. Calibration must be done at or near the flow set point for best results (refer to Section 5.8).
Cal. Zero	If Pump Control is set to MANUAL and Internal Pump is OFF , activating this command will calibrate the flow sensor zero point (refer to Section 5.8).
Sample Flow	Current sample flow through the instrument. This is only accurate when reading close to the flow calibration point.
Internal Pump	This field allows the internal pump to be turned ON or OFF. This field is only editable when the Pump Control field is set to MANUAL .

Pump Control	Set to MANUAL to disable the automatic pump control. AUTO allows the flow PID to modify the pump coarse and fine settings. START will transition to AUTO after one second.
Coarse	Internal pump speed control (Coarse). This field is only editable when the Pump Control field is set to MANUAL .
Fine	Internal Pump speed control (Fine). This field is only editable when the Pump Control field is set to MANUAL .
Valve Menu	Refer to Section 3.4.17.

3.4.13 Service Menu

Main Menu → Service Menu

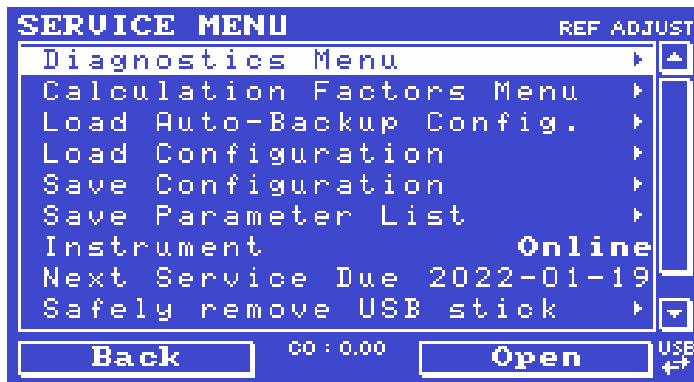

Figure 55 – Service Menu Screen

Diagnostics Menu	Refer to Section 3.4.14.
Calculation Factors Menu	Refer to Section 3.4.21.
Load Auto-Backup Config.	Loads the auto-backup configuration file. The configuration is automatically backed up every night at midnight.
Load Configuration	Loads a user selectable configuration file from the USB memory stick.
Save Configuration	Saves all of the EEPROM-stored user-selectable instrument configurations to the USB memory stick (calibration and communication settings, units, instrument gain, etc.). If there are problems with the instrument use this function to save settings to the USB memory stick and send this file (together with the parameter list save) to your supplier with your service enquiry.
Save Parameter List	Saves a text file of various parameters and calculation factors. If the user has problems with the instrument use this function to save settings to the USB memory stick and send this file (together with the configuration save) to your supplier with your service enquiry.
Instrument	This field allows the instrument to be set to either Online (normal instrument operation) or In Maintenance (data is flagged as invalid).
Next Service Due	Displays when the next scheduled service is due.

Safely Remove USB Stick	This command must be activated to safely remove the USB memory stick.
System Restart	Activating this will restart the instrument.

3.4.14 Diagnostics Menu

Main Menu → Service Menu → Diagnostics Menu



Figure 56 – Diagnostics Menu Screen

Digital Pots Menu	Refer to Section 3.4.15.
Internal Pump Menu [Internal Pump Option]	Refer to Section 3.4.16.
Valve Menu	Refer to Section 3.4.17.
Tests Menu	Refer to Section 3.4.18.
Pres/Temp/Flow Comp.	On (default): Is used to compensate instrument measurements for environmental fluctuations that might affect readings (pressure, temperature and flow). Off: Is used only when running diagnostics.
Control Loop	Enabled (default): Allows the instrument to automatically adjust digital pots and other outputs. Disabled: Prevents the instrument from changing most outputs so the service technician can manually control them.

3.4.15 Digital Pots Menu

Main Menu → Service Menu → Diagnostics Menu → Digital Pots Menu

Digital pots are electronically controlled digital potentiometers used for adjustments to operations of the instrument. Each of the digital pots can go from 0 - 255. This menu should be accessed only during diagnostics.

Unless the **Control Loop** is **Disabled** (refer to Section 3.4.14), changes to the pots may be modified by the instrument. This is intentional; some diagnostics are best done with instrument feedback and some are best done without.



Figure 57 – Digital Pots Menu Screen

PGA Gain	1 - 128	Displays the gain of the PGA.
Input Pot	180 - 230	Reduces the raw signal to measurable level.
Conc. Voltage (RAW)	0 - 3.1	The concentration voltage measured by the analog to digital converter.
Conc. Voltage	0 - 3.1	The concentration voltage after adjustment for the PGA gain factor.
Meas. Zero Pot (COARSE)	125 - 225	Electronic zero for the measure channel.
Meas. Zero Pot (FINE)	0 - 255	Electronic zero for the measure channel.
Ref. Voltage	3.5 - 4.5	The reference voltage of the detector.
Source Pot	227	Adjusts the drive current for the IR source.
IR Source	4.9 - 5.1	The voltage driving the IR source.
Cooler Pot	45	Adjusts the drive current for the cooler.
Cooler Voltage	1.15 - 1.20	The voltage being applied to the cooler.
Test Meas. Pot	0	This Digital Pot is used for diagnostics only. When in the Electrical or Preamp Diagnostic Mode , this Digital pot should be adjusted from 0 - 255. This will produce a change in the concentration voltage as well as the indicated gas concentration.
Test Ref. Pot	0	This Digital Pot is used for diagnostics only. When in the Electrical or Preamp Diagnostic Mode , this Digital Pot should be adjusted from 0 - 255. This will produce a change in the reference voltage.
Diagnostic Mode	Operate	Operate (default): Puts the instrument in normal operation mode. Electrical : Injects an artificial test signal into the electronic processing circuitry on the main controller PCA to verify that the circuitry is operating correctly. When in this Diagnostic Mode , adjust the Test Meas Pot from 0 - 255. This will produce a change in the concentration voltage as well as the indicated gas concentration. Adjust the Test Ref Pot from 0 - 255 to produce a change in the reference voltage.

Preamp: Injects an artificial test signal into the Preamplifier mounted on the **Measurement Cell** to verify that the Preamplifier, cabling and electronic circuitry on the main controller PCA is operating correctly. When in this **Diagnostic Mode**, adjust the **Test Meas Pot** from 0 - 255. This will produce a change in the concentration voltage as well as the indicated gas concentration. Adjust the **Test Ref Pot** from 0 - 255 to produce a change in the reference voltage.

3.4.16 Internal Pump Menu (Option)

Main Menu → Service Menu → Diagnostics Menu → Internal Pump Menu

This menu only appears when the internal pump option is installed. Setting the **Pump Control** to **MANUAL** will automatically disable the valve sequencing.

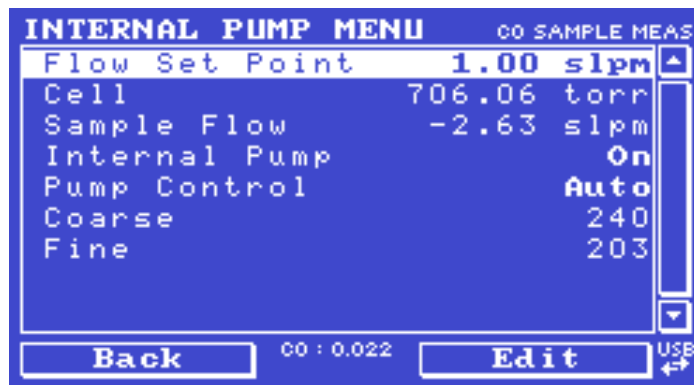

Figure 58 – Internal Pump Menu Screen

Flow Set Point	The desired sample flow target.
Cell	The current pressure in the measurement cell.
Sample Flow	Current gas flow. This is only accurate when reading close to the flow calibration point.
Internal Pump	This field allows the internal pump to be turned On or Off. This field is only editable when the Pump Control field is set to MANUAL .
Pump Control	Set to MANUAL to disable the automatic pump control. AUTO allows the flow PID to modify the pump coarse and fine settings. START will transition to AUTO after one second.
Coarse	Internal pump speed control (Coarse). This field is only editable when the Pump Control field is set to MANUAL .
Fine	Internal Pump speed control (Fine). This field is only editable when the Pump Control field is set to MANUAL .

3.4.17 Valve Menu

Main Menu → Service Menu → Diagnostics Menu → Valve Menu

The **Valve Menu** allows the user to observe the instrument controlled switching of the valves. If the valve is On it means the valve is energised. When a three-way valve is in the On state it will now be in the NC (normally closed) position as shown in the plumbing schematic. When the valve sequencing is disabled the user has the ability to turn the valve Off and On manually. It is recommended that the valve menu be used by a trained technician following the plumbing schematic (refer to Section 9.5).

Note: When interpreting the information below regarding the flow path through the valve note that (NC = Normally Closed), (NO = Normally Open) and (C = Common).

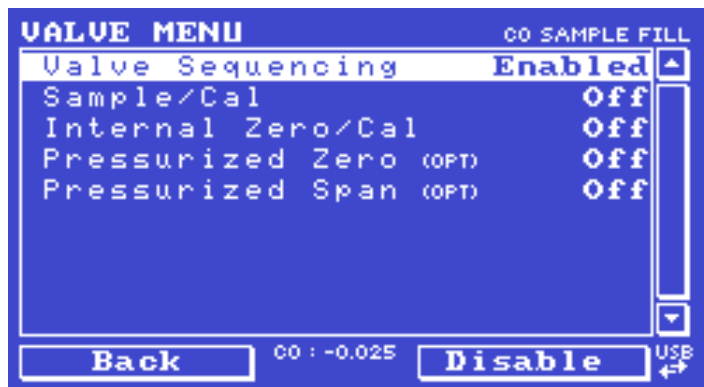

Figure 59 – Valve Menu Screen

Valve Sequencing	<p>When Enabled the valves will turn ON and OFF under the instruments control (even if the user has manually turned OFF or ON a valve).</p> <p>When Disabled the valves will change only in response to a user’s action.</p>
Sample/Cal	<p>Indicates if the Sample/Cal valve on the Calibration Valve Manifold is OFF or ON. This will determine the port the instrument draws its sample from.</p> <p>OFF = Flow from NO to C (drawing sample from the Sample Port).</p> <p>ON = Flow from NC to C (drawing sample from the Calibration Port).</p>
Internal Zero/Cal	<p>Indicates if the Internal Zero/Cal valve on the Calibration Valve Manifold is OFF or ON. This will determine the port the instrument draws its sample from, when selecting Cal. Mode → Zero.</p> <p>OFF = Flow from NO to C (drawing sample from the BGnd Air Port).</p> <p>ON = Flow from NC to C (drawing sample from the Calibration Port).</p>
Pressurised Zero (OPT) [Optional]	<p>Indicates if the optional pressurised zero port valve is OFF or ON (refer to Section 8.6).</p>
Pressurised Span (OPT) [Optional]	<p>Indicates if the optional pressurised span port valve is OFF or ON (refer to Section 8.6).</p>

3.4.18 Tests Menu

Main Menu → Service Menu → Diagnostics Menu → Tests Menu

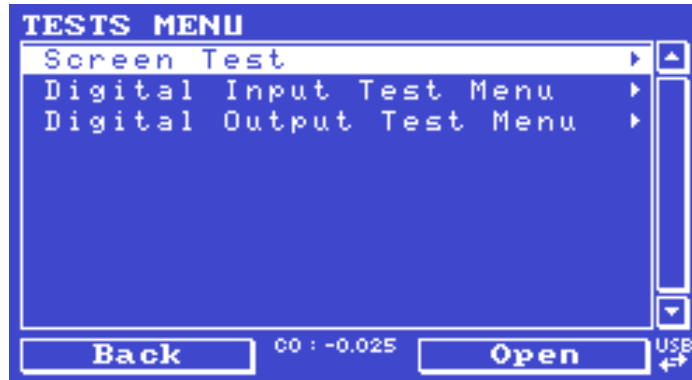

Figure 60 – Tests Menu Screen

Screen Test	Performs a screen test by drawing lines and images on the screen so that the operator can determine if there are any faults in the screen. Press a keypad key to step through the test. The up and down arrow keys will adjust the contrast.
Digital Input Test Menu	Refer to Section 3.4.19.
Digital Output Test Menu	Refer to Section 3.4.20.

3.4.19 Digital Input Test Menu

Main Menu → Service Menu → Diagnostics Menu → Tests Menu → Digital Input Test Menu

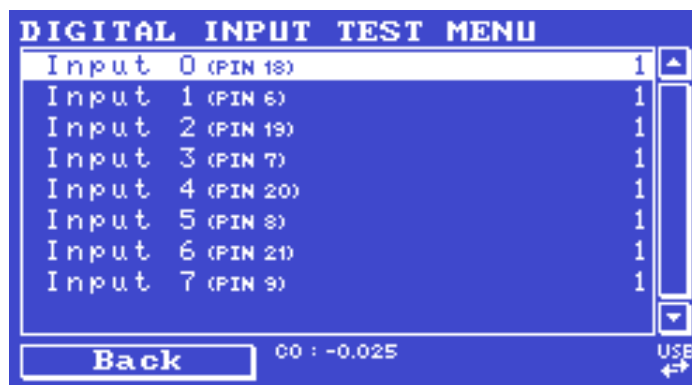

Figure 61 – Digital Input Test Menu Screen

Input 0...7	Displays the status of the 0 - 7 digital input pins and their corresponding pin out on the analog & digital I/O socket (refer to Figure 86). Value will be 0 or 1.
-------------	--

Note: Entering the **Digital Inputs Menu** will temporarily disable all digital and analog input/outputs. This will affect logging via these outputs. Exiting the menu restores automatic control.

3.4.20 Digital Output Test Menu

Main Menu → Service Menu → Diagnostics Menu → Tests Menu → Digital Output Test Menu

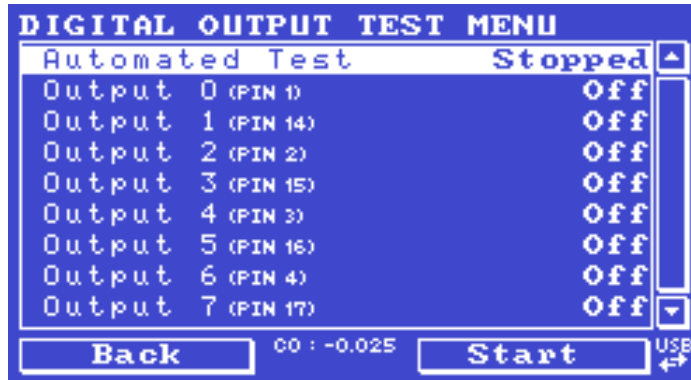

Figure 62 – Digital Output Test Menu Screen

Automated Test	When started will automatically step through each output, turning it On and Off.
Output 0...7	Displays the state (On or Off) of the output pin and their corresponding pin out on the analog & digital I/O socket (refer to Figure 86), and allows the user to manually set the state.

Note: Entering the **Digital Outputs Menu** will temporarily disable all digital and analog input/outputs. This will affect logging via these outputs. Exiting the menu restores automatic control.

3.4.21 Calculation Factors Menu

Main Menu → Service Menu → Calculation Factors Menu

The **Calculation Factors Menu** within this menu provide the values used to calculate different aspects of measurement and calibration.

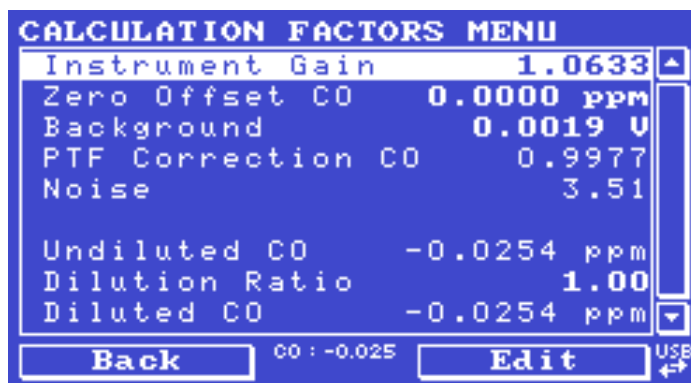

Figure 63 – Calculation Factors Menu Screen

Instrument Gain	A multiplication factor used to adjust the concentration measurement to the appropriate level (set at calibration).
Zero Offset CO	This field displays the offset created from a zero calibration. This is the concentration measured from zero air and is subtracted from all readings.
Background	The correction factor calculated from the background cycle (used to eliminate background interferences).
PTF Correction CO	Displays the correction factor applied to the concentration measurement. This correction is for changes in pressure, temperature and flows since the last calibration.
Noise	<p>The standard deviation of the concentration. The calculation is as follows:</p> <p>Take a concentration value once every 2 minutes.</p> <p>Store 25 of these samples in a first in, last out buffer.</p> <p>Every 2 minutes, calculate the standard deviation of the current 25 samples. This is a microprocessor-generated field and cannot be set by the user.</p> <p>This reading is only valid if zero air or a steady concentration of span gas has been supplied to the instrument for at least one hour.</p>
Undiluted CO	Displays the actual reading on the analyser before the dilution ratio is applied. If the Dilution ratio is 1 both undiluted CO and diluted CO field will be the same value.
Undiluted CO2 [Input 1 is CO2 Option]	Displays the actual reading on the analyser before the dilution ratio is applied. If the Dilution ratio is 1 both undiluted CO ₂ and diluted CO ₂ field will be the same value.
Dilution Ratio	<p>Entering a value here will multiply the displayed and recorded measurements by the dilution amount. For example, if the instrument is measuring a source where the average concentration is above the upper limit of the measurement range, a dilution probe with a fixed ratio dilution ratio can be used to reduce the level measured by the instrument, so for a 4:1 dilution ratio, enter a value of 4.</p> <p>Enter the ratio here so the instrument can display the correct value on the instrument.</p> <p>The default value is 1.00 (this indicates no dilution is applied).</p>
Diluted CO	Displays the current reading on the analyser after the dilution ratio is applied. If the Dilution ratio is 1 both undiluted CO and diluted CO field will be the same value.
Diluted CO2 [Input 1 is CO2 Option]	Displays the current reading on the analyser after the dilution ratio is applied. If the Dilution ratio is 1 both undiluted CO ₂ and diluted CO ₂ field will be the same value.

3.4.22 Communications Menu

Main Menu → Communications Menu

Configures how the instrument communicates with external instrumentation and data loggers.



Figure 64 – Communications Menu Screen

Data Logging Menu	Refer to Section 3.4.23.
Serial Communication Menu	Refer to Section 3.4.24.
Analog Input Menu	Refer to Section 3.4.25.
Analog Output Menu	Refer to Section 3.4.26.
Digital Input Menu	Refer to Section 3.4.27.
Digital Output Menu	Refer to Section 3.4.28.
Network Menu [Optional]	Refer to Section 3.4.29.
Bluetooth Menu	Refer to Section 3.4.30.

3.4.23 Data Logging Menu

Main Menu → Communications Menu → Data Logging Menu

When editing the numeric or text menus, the “-” key will delete the current parameter and move the others up to take its place; the “+” key will insert a parameter at the current location and move the ones below it down. The internal logger can log a maximum of 12 parameters.



Figure 65 – Data Logging Menu Screen

Data Log Interval	Displays the interval at which the data is saved to the USB memory stick. Selecting a 1 sec interval may result in occasional measurements not being logged or slow response to serial commands.
Cal. Log Interval	When enabled displays the interval at which the data is saved to the USB memory stick for the calibration time period. This occurs when the system is in Cal. Mode SPAN or ZERO . Selecting a 1 sec interval may result in occasional measurements not being logged or slow response to serial commands. Seconds (1, 2, 5, 10, 15, 30) or Minutes (1, 2, 3, 5, 10, 15, 20 or 30) or hours (1, 2, 4, 6, 8, 12 or 24). Default is Disabled.
Data Log Setup -Numeric	Numeric list of the parameters logged. This is a quicker way to enter parameters (for a list of parameters refer to Table 33).
Data Log Setup -Text	Select the list of logged parameters by name.

3.4.24 Serial Communication Menu

Main Menu → Communications Menu → Serial Communication Menu



Figure 66 – Serial Communication Menu Screen

Serial ID	This is the ID of the instrument when using multidrop RS232 communications. This ID can be changed to support multiple instruments on the same RS232 cable.
Bayern-Hessen ID [Bayern-Hessen Protocol]	This is the Bayern-Hessen ID used by the Bayern-Hessen Protocol.
CO ID [Bayern-Hessen Protocol]	This is the ID of the CO gas used by the Bayern-Hessen Protocol.
CO2 ID [Bayern-Hessen Protocol] [Input 1 is CO2 Option]	This is the ID of the CO ₂ gas used by the Bayern-Hessen Protocol. This option is only available if the user enables the Input 1 is CO2 option in the Hardware Menu (refer to Section 3.4.34).
Service port (RS232 #1) Multidrop port (RS232 #2)	The port parameters below are repeated for each serial port.

Serial Delay	Some older communication systems require a delay before the instrument responds to a serial command. The number of milliseconds of delay required (0 - 1000). The default is 0, meaning the instrument responds as quickly as possible to any serial request.
Baudrate	Sets the baud rate for this serial port (1200, 2400, 4800, 9600, 14400, 19200, 38400 or 115200).
Protocol	Sets the protocol used for this serial port (Advanced, ModBus, EC9800 or Bayern-Hessen). This must be set to Advanced for Ecotech supplied software.
Endian [Modbus Protocol]	Select Little or Big endian mode for ModBus protocol.

3.4.25 Analog Input Menu

Main Menu → Communications Menu → Analog Input Menu

The Serinus supports three analog inputs from the analog & digital I/O port. Each input is a 0 - 5 volt CAT 1 input that can be scaled and logged to the USB memory stick or accessed remotely as parameters 199 - 201.



CAUTION
Exceeding these voltages can permanently damage the instrument and void the warranty.



Figure 67 – Analog Input Menu Screen

Input 1 is CO2	When enabled several new menu items appear in other menus and the home screen now displays the CO and CO ₂ gas concentrations.
Input 1/2/3	The sections below are repeated for each analog input.
Multiplier	The input voltage will be multiplied by this number. For example, if a sensor has a 0 - 5 V output for a temperature of -40 °C to 60 °C, the multiplier would be $(60 - (-40))/5 = 20$.

Offset	This value will be added to the above calculation. Continuing the example in the multiplier description, the offset should be set to -40, so that a voltage of 0 V will be recorded as -40 °C.
Reading	The current reading from the analog input, after the multiplier and offset are applied. This is the value that is logged or reported as parameter 199 - 201.

3.4.26 Analog Output Menu

Main Menu → Communications Menu → Analog Output Menu

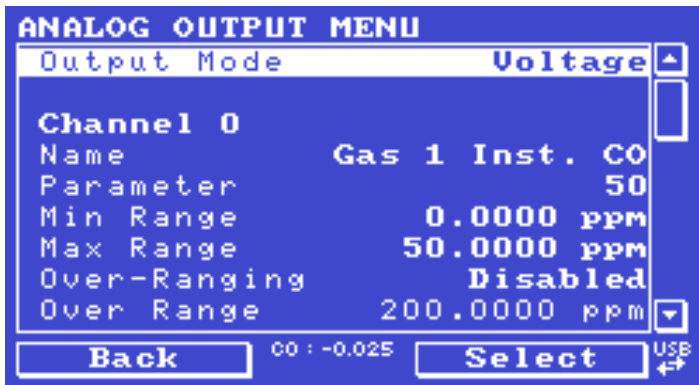

Figure 68 – Analog Output Menu Screen

Output Mode	The analog output can be set to be either Current or Voltage . Different fields will be displayed depending on which analog output type is selected.
Channel 0/1/2	Channel 0 as default will be setup to be Parameter 50, which is primary gas instantaneous reading. All three channels can be user defined to any of the available parameters (for a list of parameters refer to Table 33). All the labels below are repeated for each Channel.
Name	Text list of the parameter defined to output through the analog output (for a list of parameters refer to Table 33).
Parameter	Numeric list of the parameter defined to output through the analog output. This is a quicker way to enter parameters (for a list of parameters refer to Table 33).
Min Range	Sets the lower range limit (in concentration units). This is the value at which the analog output should be at its minimum. For example, 4 mA for a 4 - 20 mA current output.
Max Range	Sets the upper range limit (in concentration units). This value can be edited but cannot exceed the Over Range value. This is the value at which the analog output should be at its maximum. For example, 20 mA for a current output.

Over-Ranging	Set to Enabled or Disabled to turn the over-ranging feature On or Off.
Over Range	This field is only editable when Over-Ranging is set to Enabled . Set to the desired over range value. This value cannot be set below the Range value. This is the alternate scale that is used for the analog output when over-ranging is active and enabled. When 90% of the standard range is reached, this over range is automatically entered. When 80% of the original range is reached, it returns to the original range.
Hold for Cal.	When Enabled , putting the instrument into any calibration state other than MEASURE will cause it to continue reporting the last reported value.

3.4.26.1 Analog Output Menu - Voltage

Main Menu → Communications Menu → Analog Output Menu

These items appear when **Output Mode** is set to **Voltage**.

Voltage Offset	Choices are 0 V , 0.25 V or 0.5 V . This sets the voltage for a reading of 0. Since the output cannot go negative, this offset can be used to record negative readings.
0.5V Calibration	Enables the user to calibrate the analog voltage output at a low point. Edit the value against a reference volt meter until the connected equipment reads 0.5 V (refer to Section 4.4.1.1).
5.0V Calibration	Enables the user to calibrate the voltage output at a full scale point (5 V). Edit the value against a reference volt meter until the connected equipment reads 5 V (refer to Section 4.4.1.1).

3.4.26.2 Analog Output Menu - Current

Main Menu → Communications Menu → Analog Output Menu

These items appear when **Output Mode** is set to **Current**.

Current Range	Enables the user to set desired current ranges. The user's choices are 0 - 20 mA , 2 - 20 mA or 4 - 20 mA .
4mA Calibration	Enables the user to calibrate the current output at a low point. Edit the value against a reference amp meter until the connected equipment reads 4 mA (refer to Section 4.4.1.2).
20mA Calibration	Enables the user to calibrate the current output at a full scale point (20 mA). Edit the value against a reference amp meter until the connected equipment reads 20 mA (refer to Section 4.4.1.2).

3.4.27 Digital Input Menu

Main Menu → Communications Menu → Digital Input Menu

This menu is used to remotely trigger zero and span calibrations. This is done by assigning the eight digital inputs with one of the following commands.

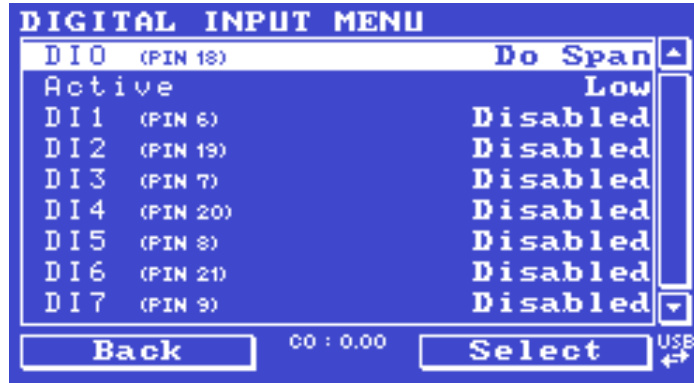

Figure 69 – Digital Input Menu Screen

DI N (Pin X)	<p>Associates an action with a digital input. There are eight digital inputs (the pin numbers are for the 25 pin connector). Each one can have one of the following associated actions, triggered when the corresponding digital input goes to the Active state:</p> <p>Disabled: No action (this digital input does nothing).</p> <p>Do Span: Used to perform a span precision check. When activated the instrument sets the Cal. Mode to Span (refer to Section 3.4.10).</p> <p>Do Zero: Used to perform a zero precision check. When activated the instrument sets the Cal. Mode to Zero (refer to Section 3.4.10).</p>
Active	<p>Each pin can be set to be active High or Low. Active High means that the event will be triggered when the line is pulled to 5 V. Active Low means that the event will be triggered when the line is pulled to 0 V.</p>

Example

Here is a typical configuration between an instrument and either a data logger or calibrator (master device):

1. Set the jumper JP1 to 5 V position (refer to Section 4.4.3).
2. Connect one of the master devices digital output signals to pin 18 and the ground signal to pin 5 of the instrument's analog/digital 25 pin female connector (refer to Figure 86).
3. Program master device to output 0 volts to pin 18 when a span is desired.
4. In the instrument's **Digital Input Menu** assign **DI 0 → Do Span** - Accept.
5. The same procedure can be followed to also activate zero calibrations. Pin 6 of the instrument's analog/digital 25 pin female connector can be connected to one of the other master devices digital outputs and the instrument can be set so **DI 1** is assigned to **Do Zero**.

3.4.28 Digital Output Menu

Main Menu → Communications Menu → Digital Output Menu

This allows the instrument to trigger external alarms in response to certain events. There are eight different pins available, which will be set high during an associated event:



Figure 70 – Digital Output Menu Screen

DO N (Pin X)	Associates a state with a digital output. There are eight digital outputs (the pin numbers are for the 25 pin connector). Each one can have one of the associated states listed in Table 6. The pin will be driven to the active state while the instrument state is true.
Active	Each pin can be set to be active High or Low . Active High means that the pin will be pulled to 5 V when the associated event occurs. Active Low means the pin will be pulled to 0 V when the associated event occurs.

Table 6 – Digital Output States

Digital Output State	Description
Disabled	No state (this state is never Active).
Pwr Supply Fail	Power supply fault.
A2D Fail	Analog to digital fault.
Corr. Wheel Fail	Correlation wheel fault.
Flow Fail	Sample flow fault.
Cell Heat Fail	Cell heater fault.
Conv. Heat Fail	CO Scrubber heater fault.
Flow Heat Fail	Flow block heater fault.
Mirror Heat Fail	Mirror heater fault.
Lamp Heat Fail	Lamp heater fault.
Chassis Tmp Fail	Chassis temperature fault.
USB Disconnected	The USB memory stick is disconnected.
Background	Performing a background.

Digital Output State	Description
Span	Performing a span check.
Zero	Performing a zero check.
System Fault	Any system fault (the red light is ON).
Maintenance Mode	User has activated maintenance mode.
Over Range AO 0	Over range for the analog output when channel 0 is active.
Over Range AO 1	Over range for the analog output when channel 1 is active.
Over Range AO 2	Over range for the analog output when channel 2 is active.

3.4.29 Network Menu (Option)

Main Menu → Communications Menu → Network Menu

The **Network Menu** only appears when the **Network Port** is enabled in the **Hardware Menu** (refer to Section 3.4.34). The **Network Menu** allows the user to view or set the IP Address, Netmask and Gateway if the optional network port is installed.



Figure 71 – Network Menu Screen

Start-up Mode

The following modes are available:

Normal: In this mode nothing is done with the network port during boot-up. It is assumed to be configured correctly or unused.

Read IP: This mode interrogates the network port for its IP address. The menu will display the network address after boot-up.

Set IP: The user may enter an IP address, Netmask and Gateway address (following the usual rules for formatting these addresses). At this time the instrument does not validate the correctness of these entries. After a user power cycle, the instrument will first instruct the network port on its new address. It will switch to **Read IP** mode and read back the address it just set so the user may verify it in the menu.

	Set DHCP: This sets the network port into DHCP mode, allowing the network to assign the instrument an IP address.
IP Address [Read IP or Set IP Start-up Mode]	This is the current IP address of the instrument.
Netmask [Read IP or Set IP Start-up Mode]	This is the subnet mask of the network the instrument is connected to.
Gateway [Read IP or Set IP Start-up Mode]	This is the IP address of the router to access addresses not on the same subnet.
ID [Set DHCP Start-up Mode]	This is the ID of the instrument. Use the keypad to edit this field. The default ID setting is Serinus(Ecotech ID) . The word Serinus is always the first part of the name and cannot be edited. The second part is the Ecotech ID .
Adaptor is in DHCP mode [Set DHCP Start-up Mode]	In this mode the instrument will ask for its network parameters from a DHCP server on your network.
Protocol	Sets the protocol used for the network port (Advanced, ModBus, EC9800 or Bayern-Hessen). This must be set to Advanced for Ecotech supplied software.
Endian [Modbus Protocol]	Select Little or Big endian mode for ModBus protocol.
Bayern-Hessen ID [Bayern-Hessen Protocol]	This is the Bayern-Hessen ID used by the Bayern-Hessen Protocol .
CO ID [Bayern-Hessen Protocol]	This is the ID of the CO gas used by the Bayern-Hessen Protocol .
CO2 ID [Bayern-Hessen Protocol] [Input 1 is CO2 Option]	This is the ID of the CO ₂ gas used by the Bayern-Hessen Protocol. This option is only available if the user has enabled the Input 1 is CO2 option in the Hardware Menu (refer to Section 3.4.34).

To read the IP address, refer to Section 4.3.1.

To set the IP address, refer to Section 4.3.2.

3.4.30 Bluetooth Menu

Main Menu → Communications Menu → Bluetooth Menu

This instrument supports Bluetooth communication through the Serinus Remote Android Application (refer to Section 4.7).

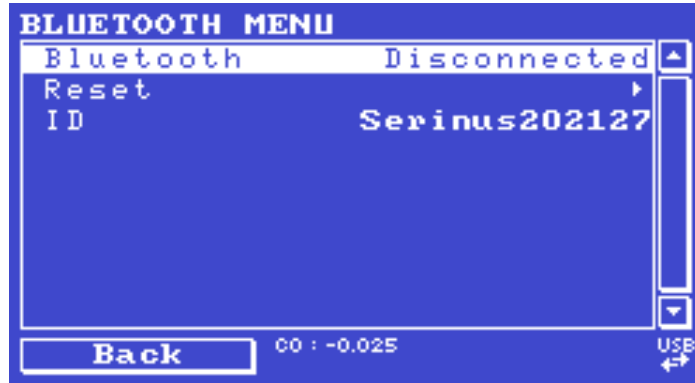

Figure 72 – Bluetooth Menu Screen

Bluetooth	This field indicates whether the instrument is remotely connected to an Android device.
Reset	After changing the ID or PIN, it is necessary to reboot the Bluetooth module. This is done by resetting the instrument or by using this menu item to reboot only the Bluetooth.
ID	This is the Bluetooth ID of the instrument. Use the keypad to edit this field. The default ID setting is Serinus(Ecotech ID) . The word Serinus is always the first part of the name and cannot be edited. The second part is the Ecotech ID .

3.4.31 Trend Display Menu

Main Menu → Trend Display Menu

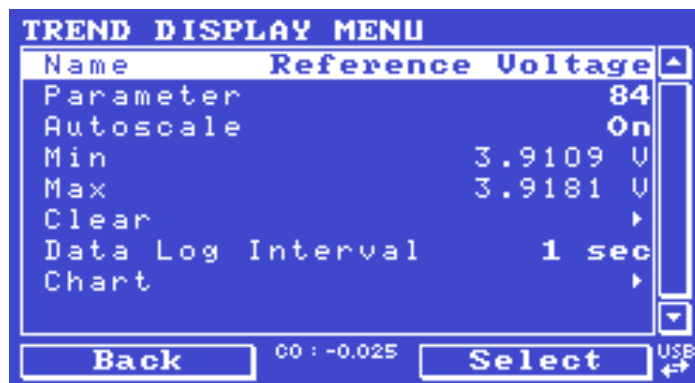

Figure 73 – Trend Display Menu Screen

Name	Displays the name of the Parameter the user has selected.
Parameter	Allows the user to select any loggable (refer to Table 33) parameter to graph on the trend display.
Autoscale	Autoscale can be ON or OFF . When it is “ ON ” the parameter will be scaled automatically for user convenience based on the current values logged.
Min	This is the minimum scale of the chart as defined by the Autoscale or the user.
Max	This is the maximum scale of the chart as defined by the Autoscale or the user.
Clear	Clears the current data points in the Chart.
Data Log Interval	The data log interval can be user set from 1 sec interval up to 24 hours .
Chart	This field enters a screen with a graph of the user selected Parameter (refer to Section 3.4.32).

3.4.32 Chart

Main Menu → Trend Display Menu → Chart

The chart allows the user to select a parameter and view it in a real time chart. The user can select from any loggable parameter (refer to Table 33). Changing the logged parameter will reset the chart. Pressing the Up or Down buttons will change between the selected parameter and the instantaneous CO gas value. Changing the Data Log Interval resets all charts.

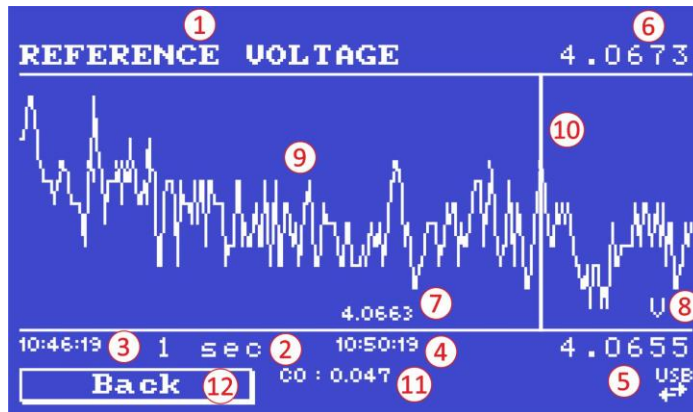

Figure 74 – Chart Screen

Chart Title (1)

Displays the name of the parameter as it would be displayed on the advanced protocol parameter list.

Data Log Interval (2)

Displays the value of the data logging interval as determined by the user in the Trend Display Menu (refer to Section 3.4.31).

Chart X-Axis (3 & 4)

(3) Displays the time stamp for the oldest data point (left hand side).

(4) Displays the time stamp for the newest data point (right hand side) or if the cursor is active it displays the current cursor data point time stamp.

Chart Y-Axis (5 & 6)

(5) This is the minimum scale as defined by the autoscale or the user (refer to Section 3.4.31).

(6) This is the maximum scale as defined by the autoscale or the user (refer to Section 3.4.31).

Current Data Point Value (7)

Displays the current value of the newest data point unless the **cursor** is active then it displays the current cursor data point value.

Units (8)

Displays the units of measure for the parameter that the user has selected.

Data Points (9)

Displays the last 240 data points recorded for the selected parameter.

Chart Cursor (10)

If the user wishes to know the value at any at a particular data point on the chart, the cursor can be used. The cursor is activated by pressing the (-) key on the keypad and is represented by a vertical line on the chart. The cursor can be moved left or right by the (-) or (+) key respectively. This cursor location now represents the current data point value of interest. The cursor will stay with the chosen data point and move with the updating chart. When the cursor finally hits the end of the chart it deactivates and the current data point value will now be the latest data point entering the chart.

Mode (11)

This field indicates the CO concentration being measured in real-time.

Back (12)

Pressing back allows the user to access other menu items while the chart is still logging in the background.

Digital Output State	Description
Left Selection Button	Returns the user back to the trend display menu.
Scrolling Buttons	Using the scrolling buttons will cycle through the user selected parameter as well as any default gas(es) currently logging.
- Button	Pressing the (-) button will bring up the cursor and move it to the left.
+ Button	Pressing the (+) button will move the cursor to the right. When the cursor moves all the way to the right due to the chart moving it will deactivate.

3.4.33 Advanced Menu

This menu is accessed via a different method than the other menus. From the **Home Screen** press the following keys: $(\bar{\cdot})99(\overset{+}{\text{SPACE}})$

This menu contains technical settings, diagnostics and factory hardware installations. No items in this menu should be accessed without authorisation and supervision of qualified service personnel.



Figure 75 – Advance Menu Screen

Language	Select a language.
Hardware Menu	Refer to Section 3.4.34
Service Displays	When set to On , new items appear on many different menus. These fields are for diagnostic and service personnel only. Default is Off .
Next Service Due	Enables the user to edit the next service due date.
Jump to Next State	Moves the sequence to the next state (e.g. from Fill to Measure). This command is most commonly used to force an instrument out of the warm-up sequence early.
Parameter Display Menu	Refer to Section 3.4.35.
Reset to Factory Defaults	Reset the configuration to factory defaults. This will erase all calibrations and user configuration information.
Rebuild Index	If a data log becomes corrupted it may be possible to restore it by rebuilding its index file. This command will ask the user to specify a month and will rebuild the index for that month. This operation can take many minutes and it should not be interrupted. While the file is rebuilding any data logging will be suspended.



CAUTION

No items in this menu should be accessed without authorization and supervision of qualified service personnel.

3.4.34 Hardware Menu

Advanced Menu → Hardware Menu

This menu contains factory hardware installations. If the user reset to factory defaults, then they may need to revisit this menu to enable their installed optional features.



Figure 76 – Hardware Menu Screen

Model	Select the instrument model. Normally this only needs to be reset when the configuration is corrupted. The selections available will depend on licensing. It is not recommended to run an instrument with firmware set to an incorrect model.
Front Panel Style	Choosing the incorrect front panel will result in the traffic lights behaving inconsistently. Default is Aluminium .
Network Port	When Enabled indicates the instrument has a network port installed. Default is Disabled .
Orifice Size [Internal Pump Option Disabled]	Specify the input orifice for instruments without an internal pump. Default is 1.08 for Standard range instruments and 1.50 for High range instruments.
Internal Pump	When Enabled indicates the instrument has an Internal pump installed. Default is Disabled .
Input 1 is CO2	When Enabled , analog input 1 is treated as a measurement of CO ₂ . This gas will appear on the Home screen and can be logged as the second gas. Default is Disabled .
External Bkgnds	When Enabled the system will not perform automatic backgrounds and it will not warn the user that it is not doing backgrounds. Rather it is the responsibility of the operator to remotely trigger the backgrounds. Default is Disabled .
IRSource Setpoint	Setpoint target for the IR Source voltage. At power up, the Source Pot will slowly adjust until this setpoint is reached. This is normally set by the factory.
Cooler Setpoint	Setpoint target for the Cooler Voltage in the IR Detector. At power up, the Cooler Pot will slowly adjust until this setpoint is reached. This is normally set by the factory

3.4.35 Parameter Display Menu

Advanced Menu → Parameter Display Menu

Used to display a parameter in real-time on the screen (refer to Table 33 for a full list of parameters).



Figure 77 – Parameter Display Menu Screen

Data Parameter	This is an editable field. Enter the parameter number the user wishes to view (refer to Table 33).
Name	Displays the name of the selected parameter.
Value	Displays the current value of the selected parameter.

4. Communications

The Serinus has a number of different interfaces for communication with other equipment (RS232, USB, 25 pin digital/analog input/output, TCP/IP network (optional) and Bluetooth). A demonstration version of Ecotech's **Airodis** software is included with the instrument, enabling basic data downloads and remote operation from a PC running a supported MS Windows operating system. The full version of Airodis is available separately and includes automated data collection, data validation and complex reporting by multiple users. Refer to the **Airodis Manual** and Section 4.6 of this manual for details on setting up and communicating with the instrument.

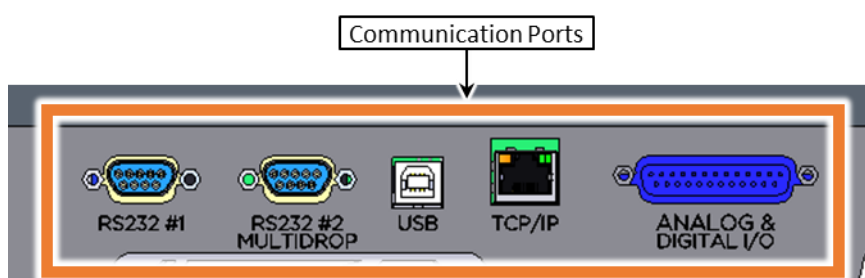

Figure 78 – Communication Ports

4.1 RS232 Communication

RS232 communication is a very reliable way to access data from the instrument and is recommended for use in connection to a data logger for 24/7 communication. Both RS232 ports are configured as DCE and can be connected to DTE (Data Terminal Equipment such as a data logger or computer).

Port #2 also supports a multidrop arrangement (a configuration of multiple instruments connected via the same RS232 cable where the transmit signal is only asserted by the instrument that is spoken to).

For reliable multidrop RS232 communications follow these guidelines:

- Verify that the Serial ID is set to a unique value which is different to the other instruments in the chain (refer to Section 3.4.24).
- All of the instruments in the multidrop chain must have the same baud rate and communication protocol settings. A maximum of 9600 baud rate is recommended.
- The multidrop RS232 cable should be kept to less than three meters in length.
- A 12K ohm terminating resistor should be placed on the last connector of the cable (connect from pin 2 to pin 5 and from pin 3 to pin 5 – refer to Figure 79).
- The shielding of the multidrop cable must be continuous throughout the cable.
- The shielding of the multidrop cable must only be terminated at one end. It should be connected to the metal shell of the DB 9 way connector.

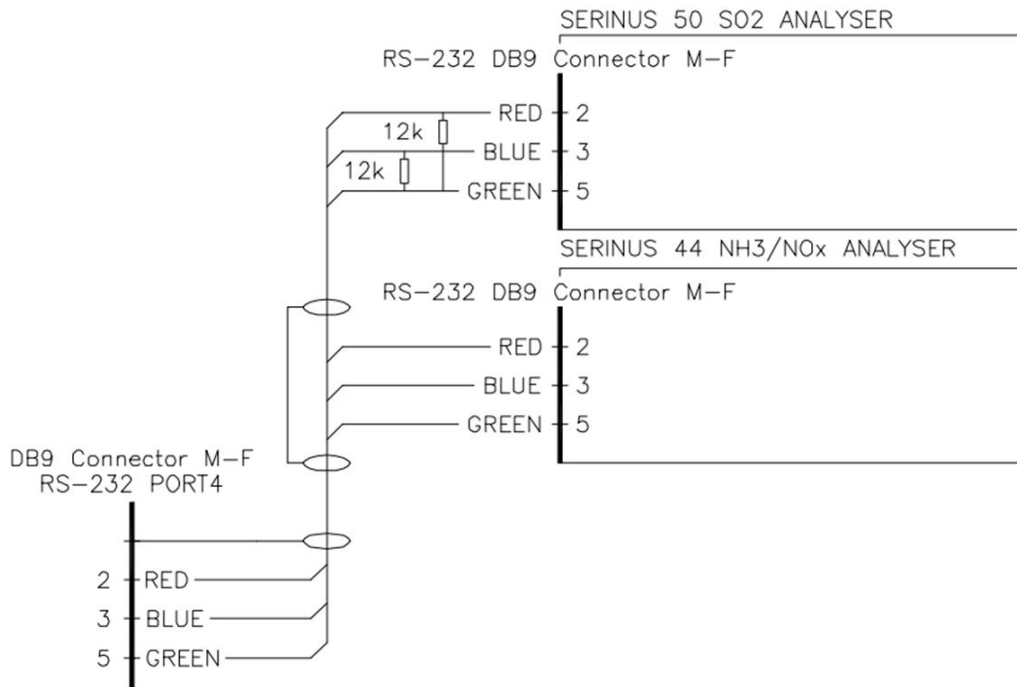

Figure 79 – Multidrop RS232 Cable Example

4.2 USB Communication

This is ideal for irregular connection to a laptop running Ecotech’s **Airodis** software to download logged data and remotely control the instrument. Due to the nature of USB, this is a less reliable permanent connection as external electrical noise can cause USB disconnection errors on a data logger.

For more information regarding connecting over USB, refer to Section 4.6.1.1.

Note: Only the Advanced protocol is supported for USB communication.

4.3 TCP/IP Network Communication (Optional)

Instruments with the optional network port installed can be accessed using a TCP/IP connection. Figure 80 shows examples of some possible configurations for remote access.

Direct Connection

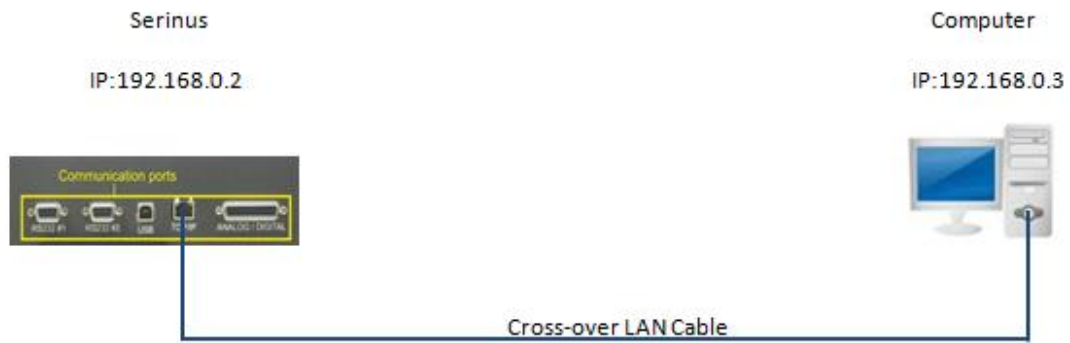

LAN

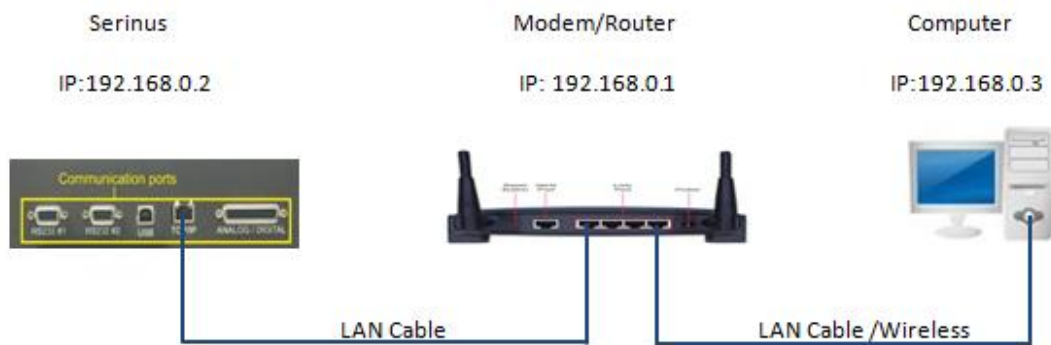

WAN

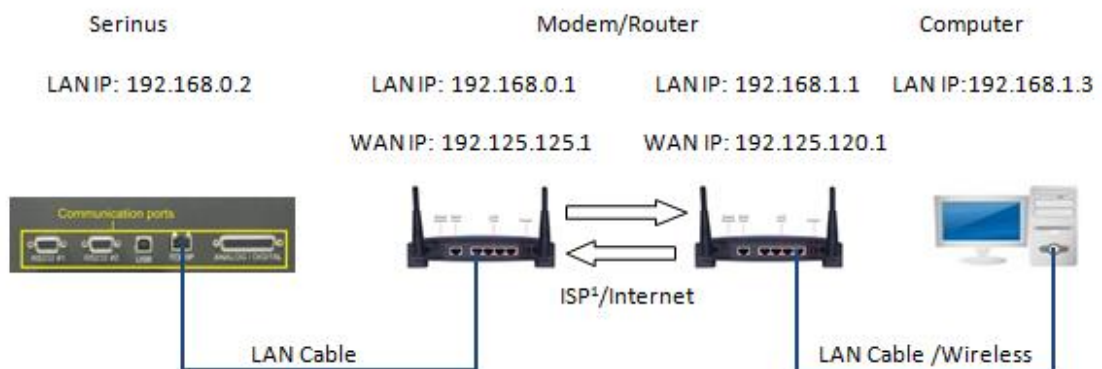

¹ ISP: Internet Service Provider

Figure 80 – Example of Typical Network Setups

Note: In Figure 80 all the IP addresses are taken as an example. The WAN IP addresses are normally provided by your ISP. Whereas, the LAN IP addresses can be set manually to any range which is within the subnet of the Modem/Router/Switch.

Use a cross-over LAN cable to connect the instrument directly to a computer, or a standard LAN cable for connection to a Modem/Router/Switch as shown in Figure 80. The computer could be connected to the Modem/Router using either CAT5 cable or a wireless connection, but the instrument must be connected using CAT5/6 cable.

4.3.1 Reading Network Port Setup

To read the current network port settings perform the following steps:

Procedure

1. Open - **Main Menu** → **Communications Menu** → **Network Menu**.
2. Select - **Start-up Mode** → **Read IP** - Accept.
3. Manually use the power switch ON the rear of the instrument to turn the power OFF. Leave the instrument OFF for 10 seconds before turning the power back ON.
4. Open - **Main Menu** → **Communications Menu** → **Network Menu**.
5. The current network port settings will now be displayed on the screen.
6. When viewing is complete select - **Start-up Mode** → **Normal** - Accept.

4.3.2 Setting Network Port Setup

Below is an example of how to setup the network port.

Procedure

1. Open - **Main Menu** → **Communications Menu** → **Network Menu**.
2. Select - **Start-up Mode** → **Set IP** - Accept.
3. Edit - **IP Address** - (Change the IP address to the address the user wishes to use within the Modem/Router/Switch Subnet).
4. Edit - **Netmask** - (Change the Netmask to the setup specified by the Modem/Router).
5. Edit - **Gateway** - (Change the Gateway to the setup specified by the Modem/Router).

6. Select - **Protocol** → **Advanced** - Accept.

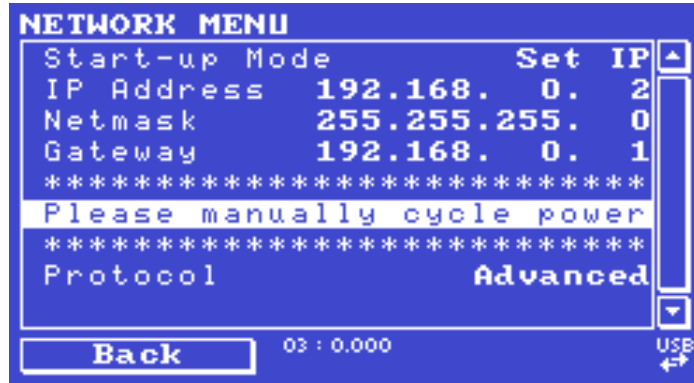

Figure 81 – Example of Network Menu Setup

7. Once completed, use the power switch on the rear of the instrument to turn the power OFF. Leave the instrument OFF for 10 seconds before turning the power back ON.

Note: Manually perform a hardware power cycle every time the IP address is changed for it to take effect.

8. Open - **Main Menu** → **Communications Menu** → **Network Menu**.
9. The **Start-up Mode** automatically changes to **Read IP** and the current network port settings will be displayed on the screen.
10. When viewing is complete select - **Start-up Mode** → **Normal** - Accept.

4.3.3 Port Forwarding on Remote Modem/Router Setup

When using the network port to connect to the router / modem with NAT enabled, the user will need to add IP mapping to ensure that data is forwarded through to the desired port. This is known as port forwarding. To set-up the port for the instrument, the user needs to go into the modem/router configuration. Normally, the user will see the port forwarding setup under Port Forwarding, NAT, or Port Mapping menu. Below is an example port forwarding setup .

The default port for the Serinus range of instruments is **32783**. The destination address is the instrument IP address setup in the **Network Menu**.

Item	Protocol	Incoming Address	Incoming Port	Destination Address	Destination Port
1	tcp	0.0.0.0	32783 - 32783	192.168.0.2	32783 - 32783

Figure 82 – Port Forwarding Example

4.3.4 Airodis Setup to Communicate with Serinus

Below is an example of Airodis setup for a LAN network. Ensure the IP address is set to the same as on the instrument **Network Menu**.

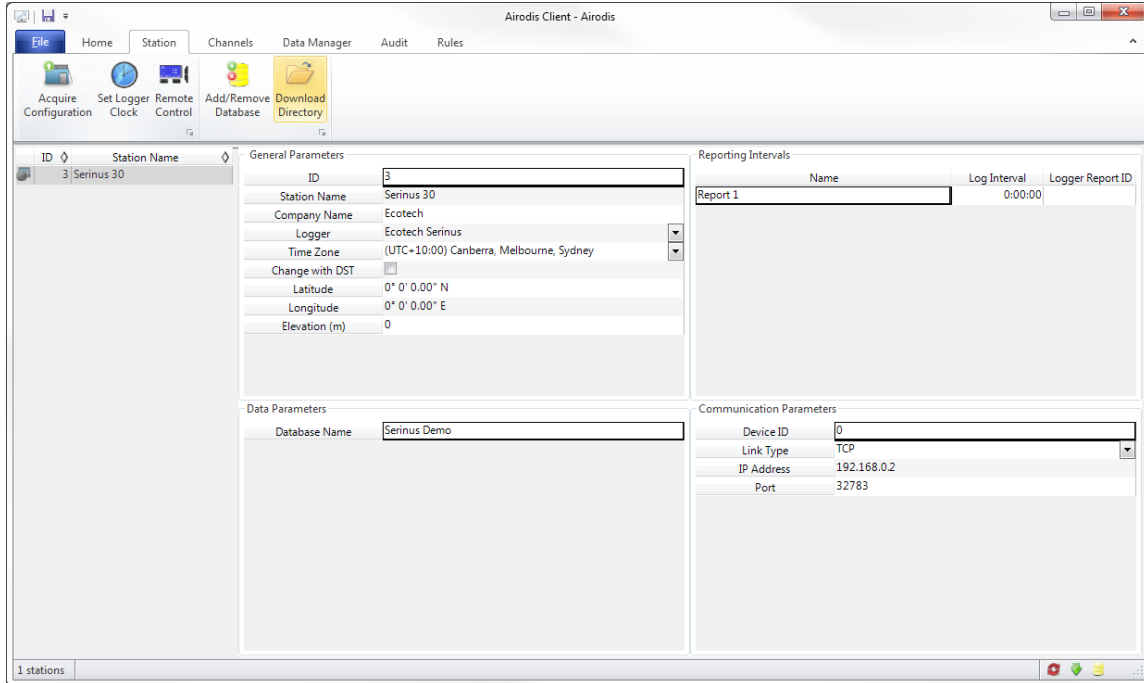

Figure 83 – LAN Network Set-Up (Airodis)

Below is an example of Airodis setup for a WAN network. Ensure the IP address is set the same as on the remote modem/router.

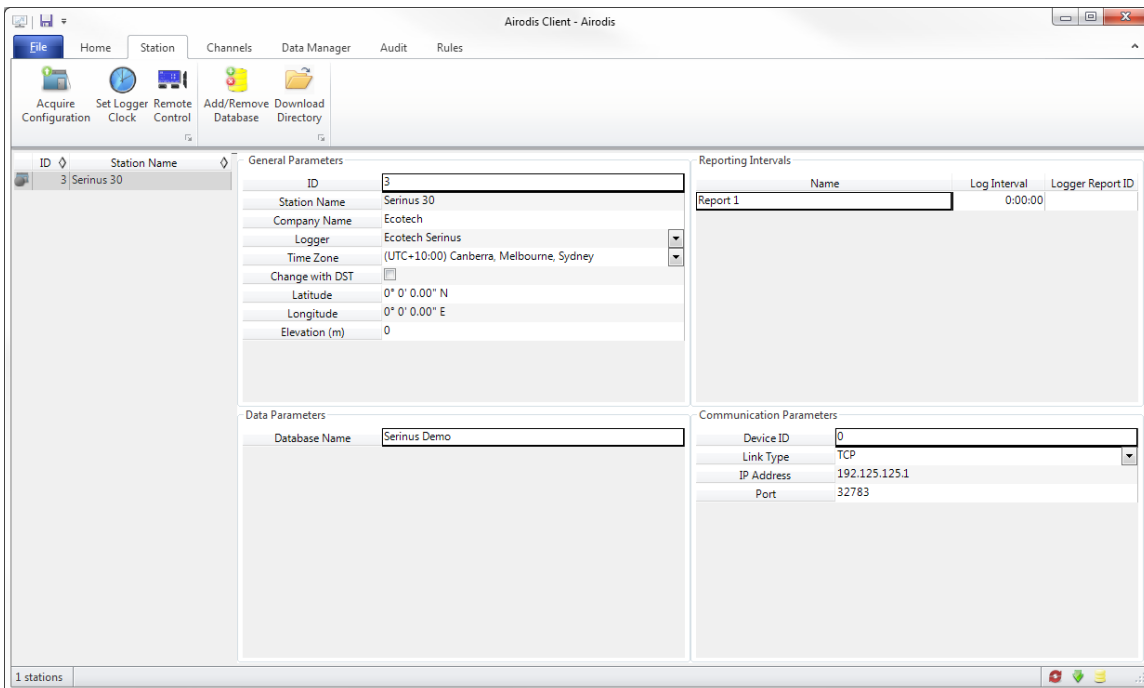

Figure 84 – WAN Network Set-Up (Airodis)

4.4 Analog and Digital Communication

The 25 Pin analog and digital I/O port on the rear panel of the instrument sends and receives analog and digital signals to other devices. These signals are commonly used to activate gas calibrators or for warning alarms.

4.4.1 Analog Outputs

The instrument is equipped with three analog outputs that can be set to provide either voltage (0 - 5, 0.25 - 5 or 0.5 - 5 V) or current (0 - 20, 2 - 20 or 4 - 20 mA) output. The analog outputs are tied to user selected parameters (refer to Table 33).

For 0 - 10 V analog output operation, set the output mode to current and move the jumpers (JP3) on the rear panel PCA to 0 - 10 V (refer to Figure 85). Ensure the current range is set to 0 - 20 mA to obtain the 0 - 10 V range. When calibrating the (current) analog output with the jumper set to 0 - 10 V, the 4 mA calibration target is now a 2 V target and 20 mA calibration target is now a 10 V target.

4.4.1.1 Analog Outputs Voltage Calibration

Equipment Required

- Multimeter (set to volts)
- Male 25 pin connector with cable

Procedure

1. Open - **Main Menu** → **Communications Menu** → **Analog Output Menu** (refer to Section 3.4.26).
2. Select - **Output Mode** → **Voltage**.
3. Connect a multimeter (using an appropriate adaptor or probes on the multimeter) to the ground (pin 24) and the relevant output pin (pin 10).
4. Edit - **0.5V Calibration** - (until the multimeter reads $0.500\text{ V} \pm 0.002$) - Accept.
5. Edit - **5.0V Calibration** - (until the multimeter reads $5.00\text{ V} \pm 0.002$) - Accept.

4.4.1.2 Analog Outputs Current Calibration

Equipment Required

- Multimeter (set to mA)
- Male 25 pin connector with cable

Procedure

1. Open - **Main Menu** → **Communications Menu** → **Analog Output Menu** (refer to Section 3.4.26).
2. Select - **Output Mode** → **Current**.
3. Connect a multimeter (using an appropriate adaptor or probes on the multimeter) to the ground (pin 24) and the relevant output pin (pin 10).
4. Edit - **4 mA Calibration** - (until the multimeter reads $4\text{ mA} \pm 0.01$) - Accept.
5. Edit - **20 mA Calibration** - (until the multimeter reads $20\text{ mA} \pm 0.01$) - Accept.

4.4.2 Analog Inputs

The instrument is also equipped with three analog inputs with resolution of 15 bits plus polarity, accepting a voltage between 0 - 5 V. These go directly to the microprocessor and should be protected to ensure static/high voltage does damage the main controller PCA (instrument warranty does not cover damage from external inputs).

4.4.3 Digital Status Inputs

The instrument is equipped with eight logic level inputs for the external control of the instrument such as Zero or Span sequences. Each input has a terminating resistor which can be either PULL UP or PULL DOWN. This is set using the jumper JP1 on the rear panel PCA (refer to Figure 85).

4.4.4 Digital Status Outputs

The instrument is equipped with eight open collector outputs which will convey instrument status condition warning alarms such as no flow, sample mode, etc. Two of the digital outputs can be set so that there is +5 V and +12 V available on the 25 pin connector for control purposes, instead of digital outputs 0 and 1.

In the default jumper locations (refer to Figure 85) these two outputs will function normally as open collector outputs. If moved to the position closer to the 25 pin connector, then the DO 0 will supply +12 V and DO 1 will supply +5 V.

The +12 V and +5 V supplies are limited to about 100 mA each.

Each digital output is limited to a maximum of 400 mA. The total combined currents should not exceed 2 A.

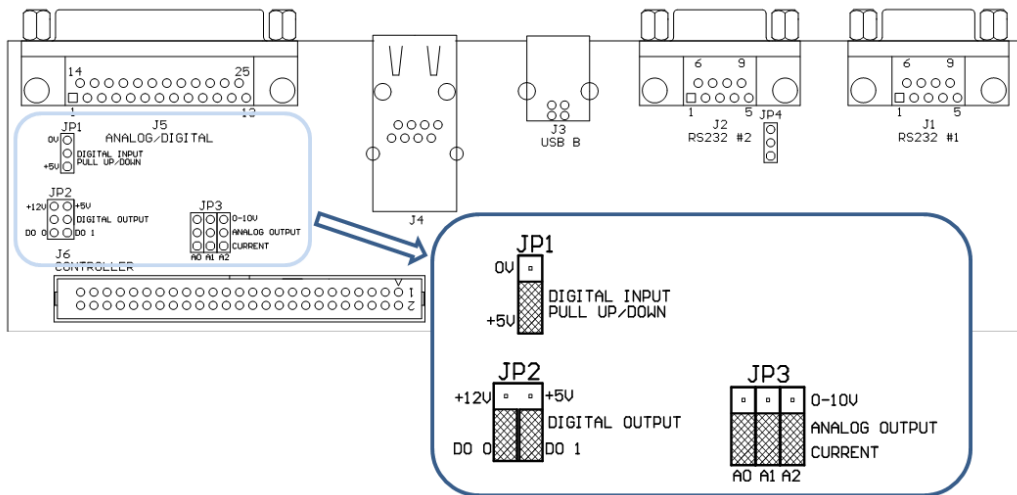

Figure 85 – 25 Pin Rear Panel PCA (Default Jumpers Highlighted)

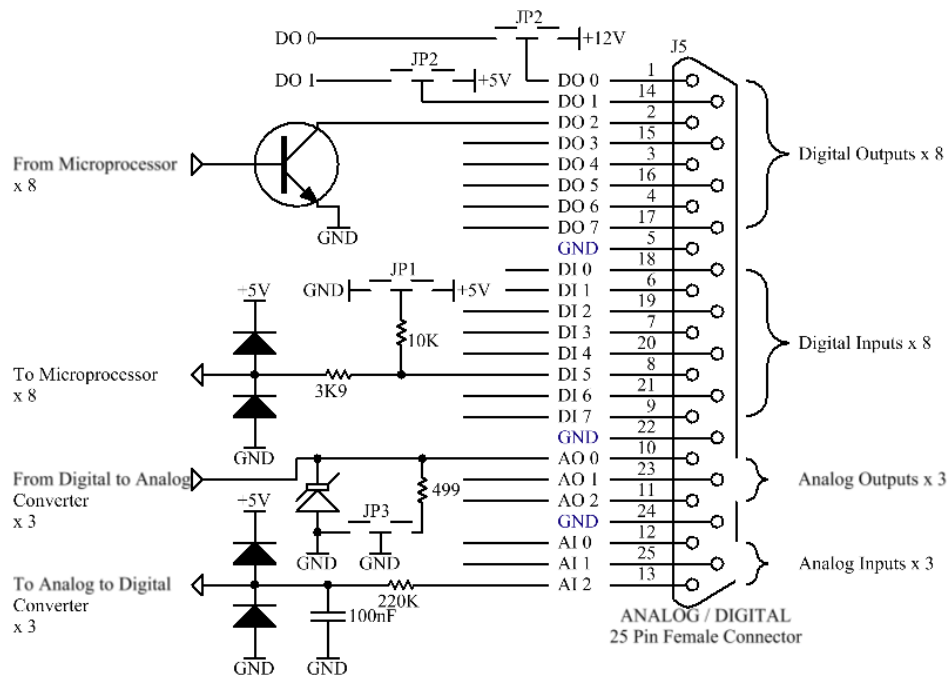

Figure 86 – Analog & Digital I/O Individual Pin Descriptions



CAUTION

The analog and digital inputs and outputs are rated to CAT I. Exceeding 12 VDC or drawing greater than 400 mA on a single output or a total greater than 2 A across the eight outputs can permanently damage the instrument and void the warranty.

4.5 Logging Data

When the user receives the instrument from the factory it will have a default set of parameters already setup in the internal data logger. These select few parameters have been chosen for their relevance in assisting in troubleshooting the instrument.

4.5.1 Configure Instrument Internal Logging

In order to log data the user must first specify a data logging interval. This is how often data will be logged to the USB memory stick. The user can log a maximum of 12 parameters. These parameters can be selected by name or by parameter number using the parameter list as a reference (refer to Table 33).

4.5.1.1 Data Log Setup –Numeric

Procedure

1. Open - **Main Menu** → **Communications Menu** → **Data Logging Menu** (refer to Section 3.4.23).
2. Select - **Data Log Interval** - (adjust to the desired value) - Accept.
3. Open - **Data Log Setup -Numeric** - (select the parameter numbers user wishes to log).

4. Edit - (Change one of the storage locations “Parameter 1 - 12” to the parameter number user wishes to log) - Accept.

4.5.1.2 Data Log – Text

Procedure

1. Open - **Main Menu** → **Communications Menu** → **Data Logging Menu** (refer to Section 3.4.23).
2. Select - **Data Log Interval** - (adjust to the desired value) - Accept.
3. Open - **Data Log Setup –Text** - (select the names of the parameters user wishes to log).
4. Select - (Change one of the storage locations “P1 - P12” to the parameter text user wishes to log) - Accept.

4.6 Using Airodis Software to Download Data

4.6.1 Connecting the Instrument to a PC

The instrument can communicate with a PC using RS-232 (Serial), TCP/IP (Network), Bluetooth or USB. Serial, Bluetooth and network communications do not require additional drivers. If the user wishes to connect using a USB cable, the driver must first be installed.

4.6.1.1 Connecting Over USB

If the user wishes to connect using USB, then they will need to first install the Serinus USB driver.

Power ON the instrument and connect it to a PC with a USB cable. The user should receive a prompt if the driver needs to be installed. If not, open Device Manager (Under “System” in Control Panel), find the device and select “Update Driver Software”.

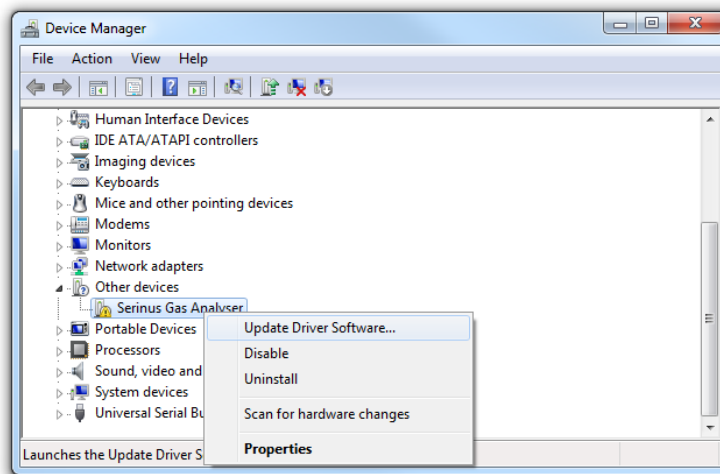

Figure 87 – Installing Driver Software (Device Manager)

When prompted where to search for the driver, select “**Browse my computer for driver software**”.

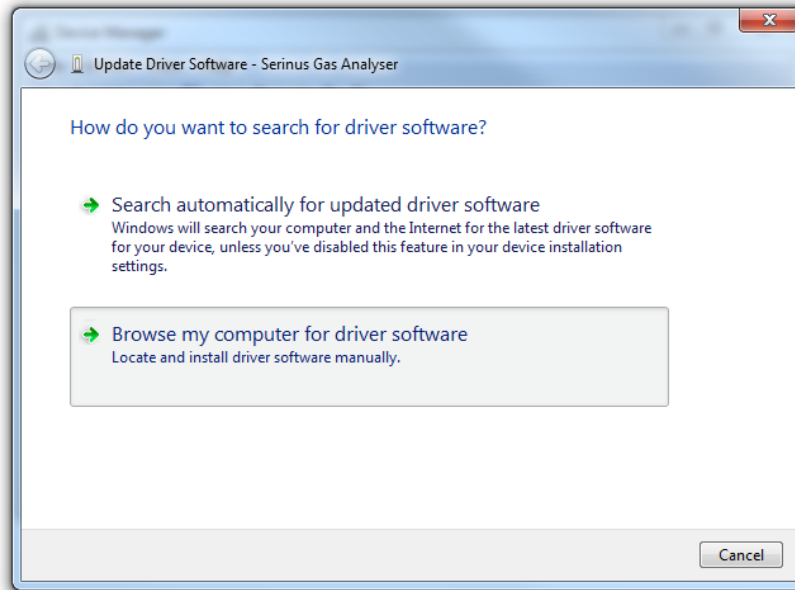

Figure 88 – Update Driver Popup

The Serinus USB driver is located on the green Ecotech resources USB stick under “\Drivers\Ecotech Analyser”. Select this directory and click **Next**.

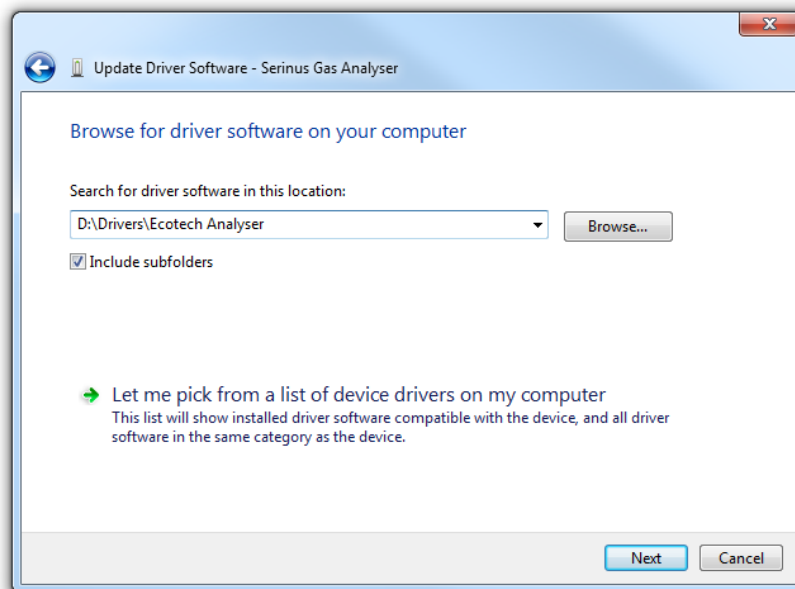

Figure 89 – Update Driver Popup (Directory Location)

If the user receives a confirmation prompt to install the driver, select **Install**.

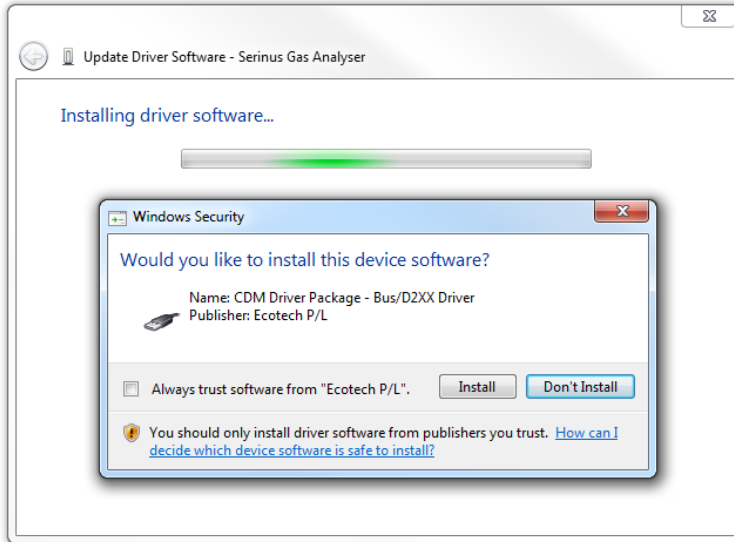

Figure 90 – Installing Driver Confirmation Prompt

If everything went smoothly, Windows will inform the user that the driver was successfully installed.

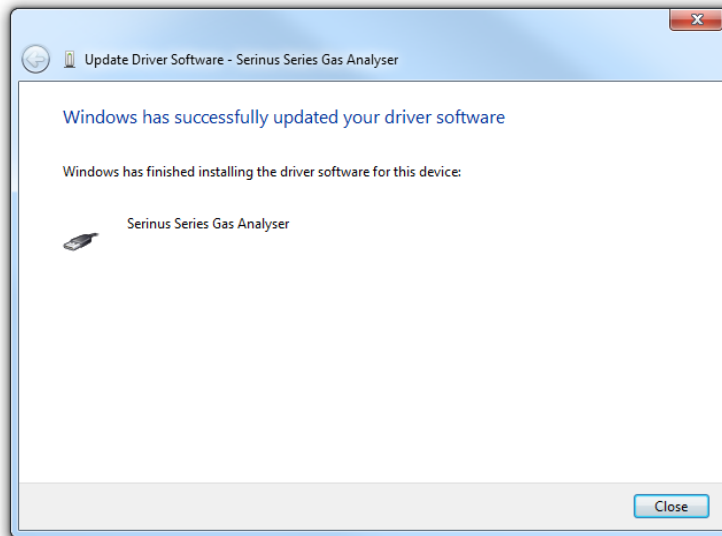

Figure 91 – Successful Driver Installation

4.6.1.2 Connecting Over Serial (RS-232)

The following steps outline how to setup the instrument for connection to a PC or datalogger (refer to Section 3.4.24).

Procedure

1. Open - **Main Menu** → **Communication Menu** → **Serial Communication Menu**.
2. Determine which RS232 Port the user is physically making the connection with. Remember, multidrop is only supported on RS232 #2.

-
3. Select - **Baudrate** → **38400** - Accept (Set an appropriate baud rate, default is 38400).
 4. Select - **Protocol** → **Advanced** - Accept.

If the user is running Airodis in a multidrop configuration, ensure that the **Serial ID** is unique for each instrument on the chain.

4.6.1.3 Connecting Over Network (TCP/IP)

Refer to Section 4.3.2 to setup the instrument for connection to a PC or datalogger using a static IP address.

4.6.2 Installing Airodis

The user can download data from the instrument using either a full retail (paid) version of Airodis or with the demo version which is included on the green Ecotech resources USB stick. The demo version has limited functionality, but will allow the user to download and export data from up to three instruments. If the user doesn't have Airodis Installed, they can obtain it from the following address:

<http://www.airodis.com.au>

The installer is straightforward: Ensure the user selects the correct version of software to install for their operating system. If they are running 64-bit windows, install the 64-bit (x64) version. Otherwise, install the 32-bit (x86) version.

4.6.3 Configuring Airodis

1. Once installed, double click on the Airodis shortcut on the desktop to start Airodis Workspace Manager. The user will be presented with the default workspace options. These will suffice for downloading data from the instrument.

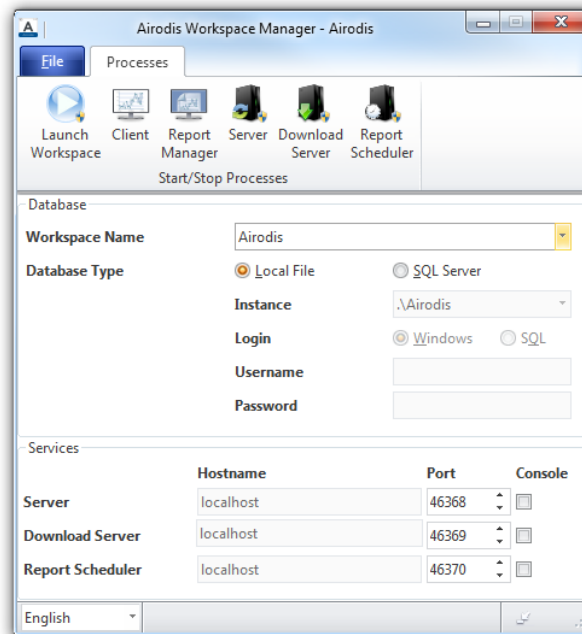

Figure 92 – Airodis Workspace Manager

2. Start the Client, Server and Download Server by single-clicking the toggle button for each. The client may prompt to register with Ecotech or install an update. Follow the prompts if it does.
3. Once the Client application has loaded, click **Home → Add Station → New Physical Station**.

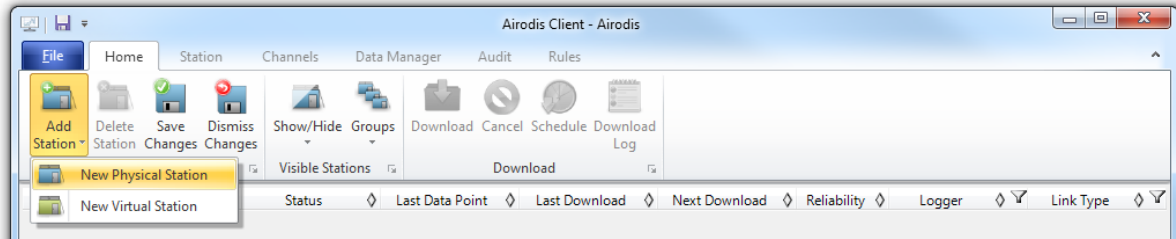

Figure 93 – Adding a New Station

4. This automatically brings the user to the **Station** tab on the ribbon. Enter the communication details to connect to the instrument.

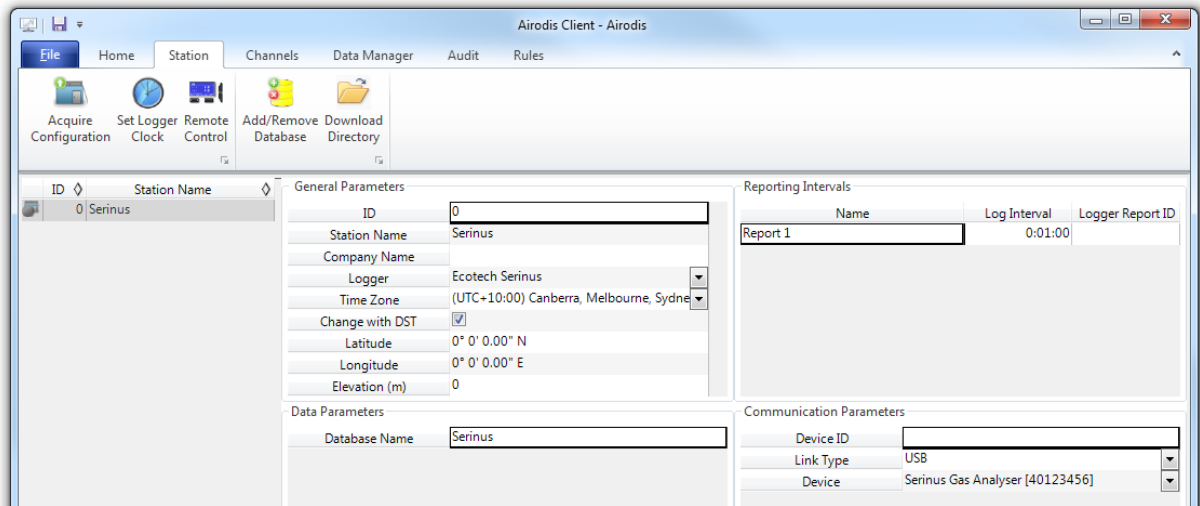

Figure 94 – New Station Connection

Table 7 – New Station Setup

Property	Description
Station Name	The name of the station. If the user has other loggers, the name is used to distinguish them.
Logger	Set this to “Ecotech Serinus” when downloading from any Serinus series instrument. This will communicate with the instrument via the Advanced protocol. If using a network or serial connection, ensure that the Advanced protocol has also been selected on the instrument itself.
Time Zone	Set this to the time zone that the instrument is located in.
DST	Enable this option if the user plans on changing the clock on the instrument with daylight savings. Leave this disabled if the clock does not shift during DST. The instrument will need to be adjusted manually for DST – it will not happen automatically.

Property	Description
Database Name	This is the name to be used for the table in the SQL database containing this station's data. It must be unique for each station.
Device ID	Enter the Serial ID of the instrument. If the user is not using multidrop; this can be set to "0" or left blank.
Link Type	Select the type of connection used to connect to the instrument. Different properties will appear depending on the link type selected. Align these settings with those of the instrument.
Log Interval	This needs to be the same as the Data Log Interval setting on the instrument.

Note: The available fields for communication parameters will change when the user changes the link type. The user will need to set the communication parameters that have been defined on the instrument.

- Once the station has been created, save the station by clicking the Save shortcut icon or **File → Save**.
- Click **Acquire Configuration**. This will probe the instrument for a channel list. After a few seconds, the channel list should be visible in the **Channels** tab.

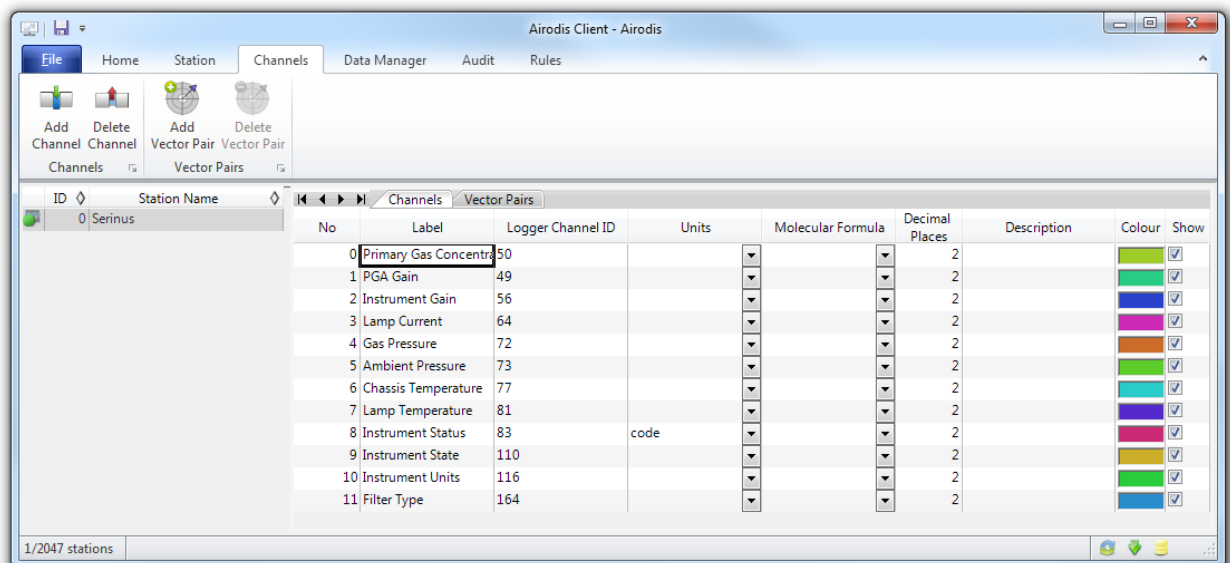

Figure 95 – Station Configuration (Channel List)

Note: If there was an error connecting to the instrument, a red dot will appear next to the station name in the station list (on the far left hand side). Hovering over the red dot will present the user with an error message (refer to Figure 96).

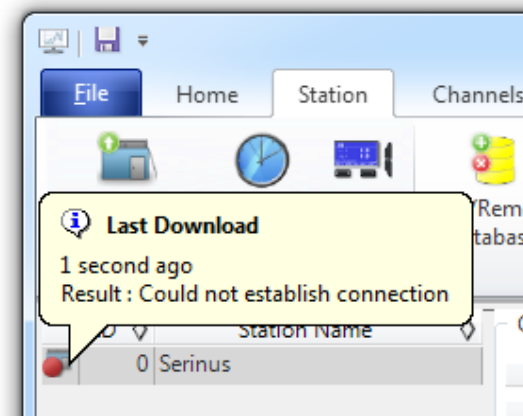

Figure 96 – Error Status Notification

7. Select the Data Manager tab, click download. The Download Data window will appear. Select the appropriate time period that the user wishes to download and click Download.

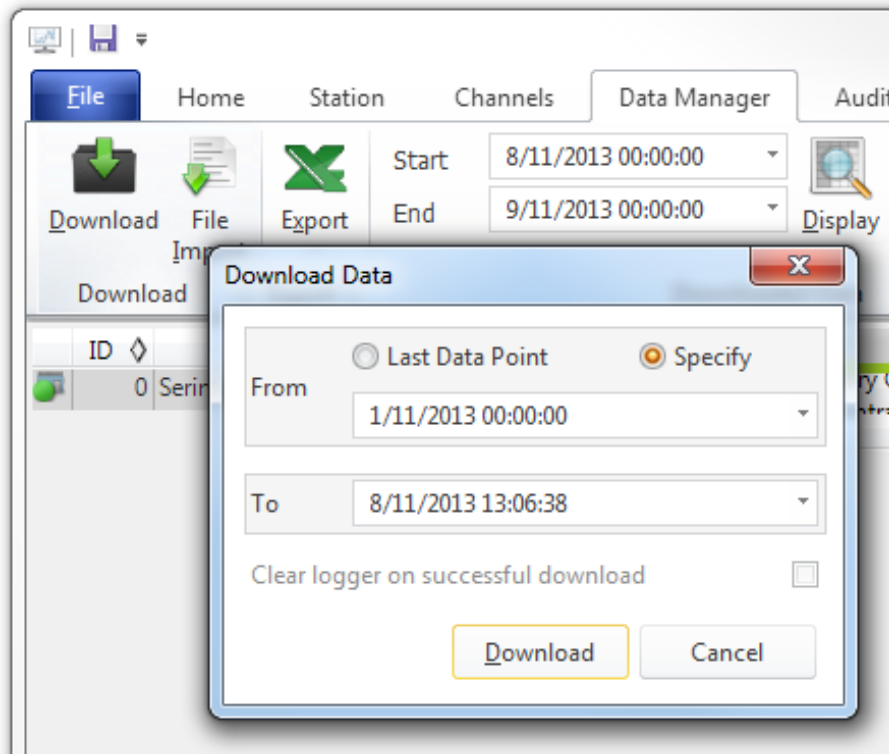

Figure 97 – Downloading Data

8. The status of the download will appear in the bottom-left corner of the window. The user can also monitor the status of the download from the Home tab.

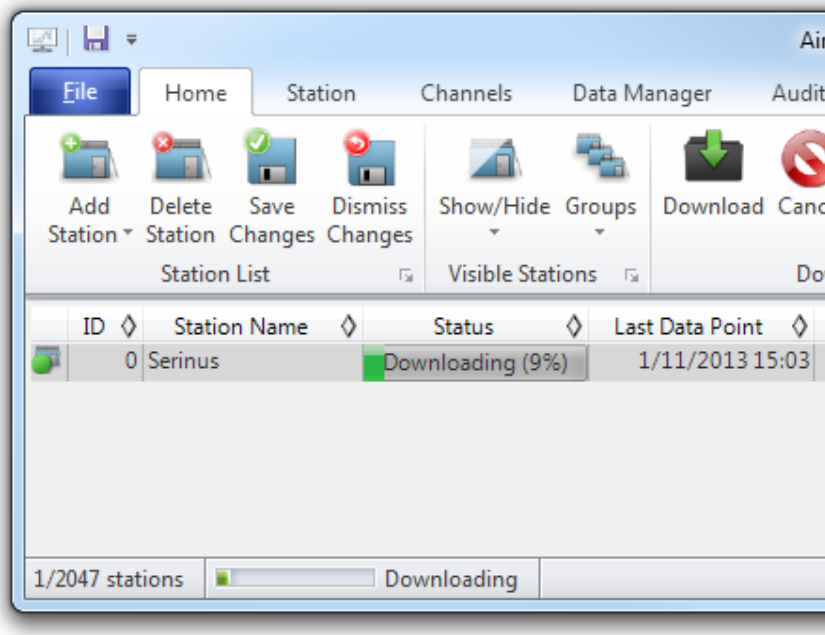

Figure 98 – Download Data Status

9. Data will become available in the data manager as it is downloaded. The user can load data for a date range by entering the start and end dates and clicking **Display**. The selected data will be loaded into the data manager.

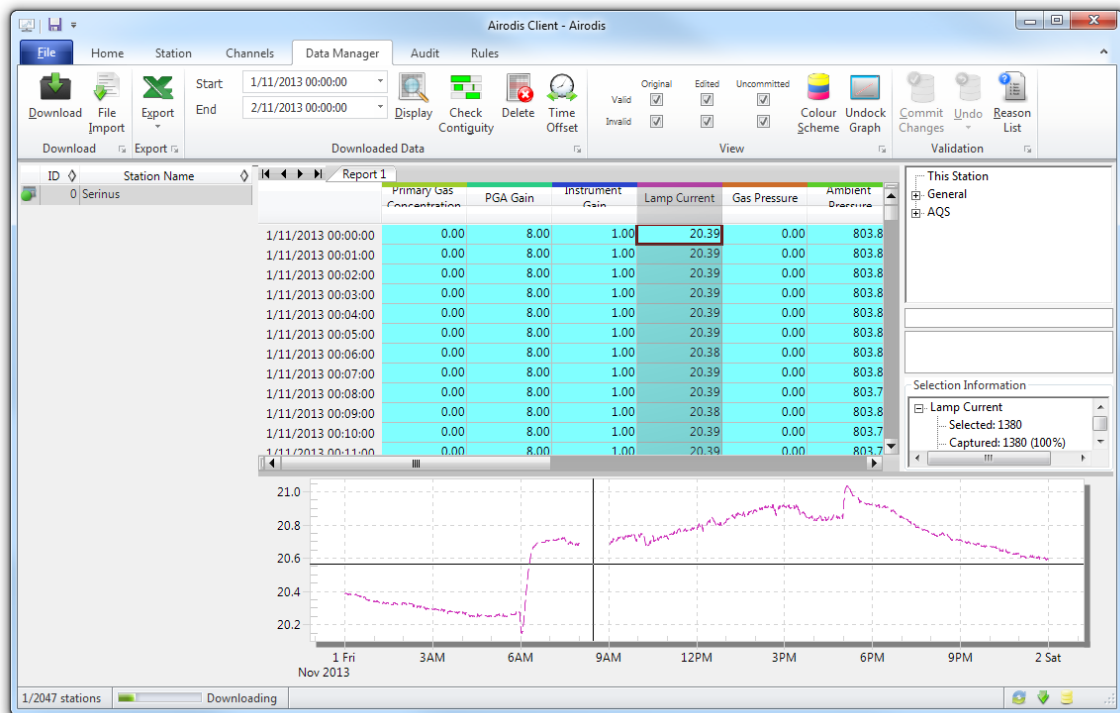

Figure 99 – Data Visibility

10. Data can be exported by clicking the Export function. This will allow the user to save their data in CSV format, which can be loaded into another program such as Microsoft Excel. It is also possible to copy/paste (Ctrl + C / Ctrl + V) data directly from the Airodis data manager.

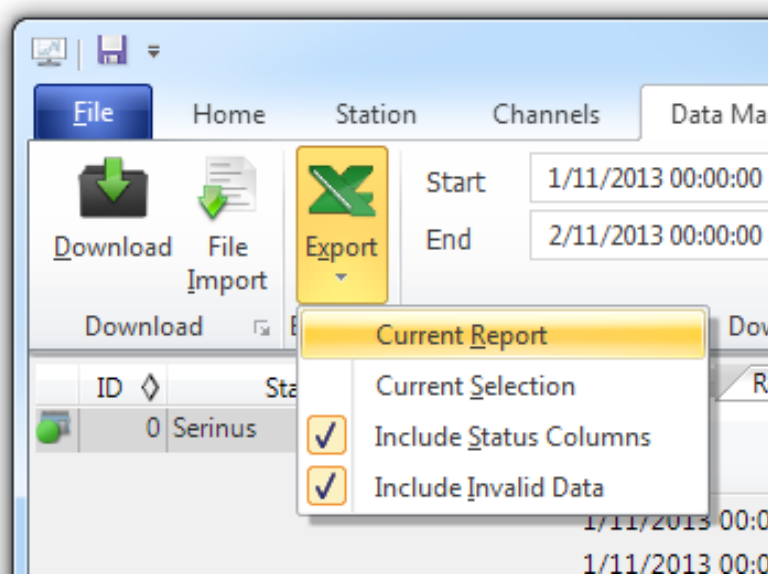

Figure 100 – Exporting Data

11. That’s it! The data has been downloaded from the instrument and exported to a standard CSV file.

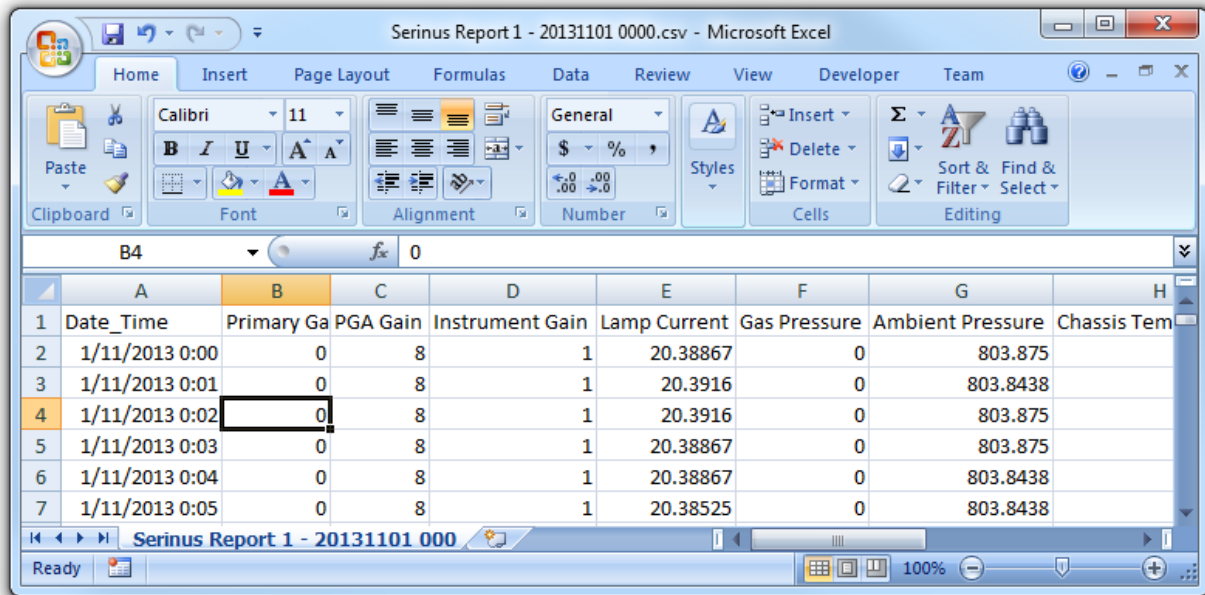

Figure 101 – Data Download Complete

4.7 Serinus Remote App/Bluetooth

The Serinus Remote Application allows for any Android device (Tablet or Smartphone) to connect to an instrument.

The Serinus Remote Application allows the user to:

- Completely control the instrument using a remote screen displayed on the device.
- Download logged data and take snapshots of all the instrument parameters.
- Construct graphs from logged data or real time measurements.

The following sections cover installation, connection and use of the application.

4.7.1 Installation

The Serinus Remote Application can be found in the Google Play Store by searching for Ecotech or Serinus. Once found, choose to **Install** the application and **Open** to start the application.

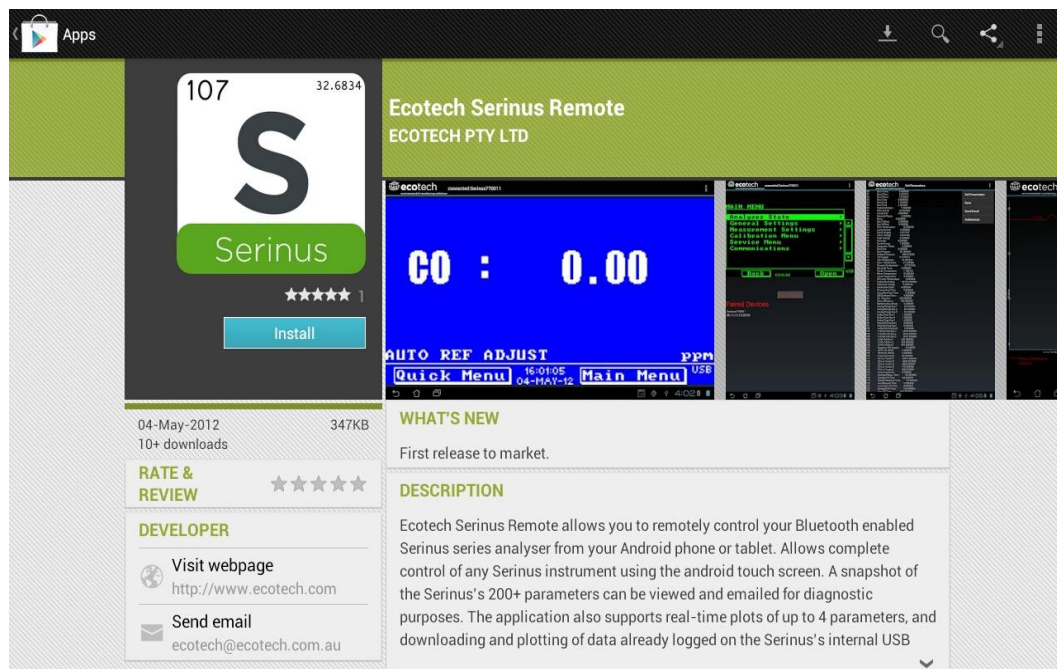

Figure 102 – Downloading the App from Google Play Store

Note: A menu containing additional features and functions can be accessed by entering the **Options Menu** (or similar) on the device. The location and format of this menu may vary.

4.7.2 Connecting to the Instrument

Procedure

1. Open - **Main Menu** → **Communications Menu** → **Bluetooth Menu** (to find the Bluetooth ID) (refer to Section 3.4.30).
2. Touch the Scan Serinus Analysers button at the bottom of the device screen.
3. Select the Analyser ID from either the **Paired Devices** or the **Other Available Devices**.

4. Input the PIN (if prompted) and press OK (refer to Section 3.4.30).

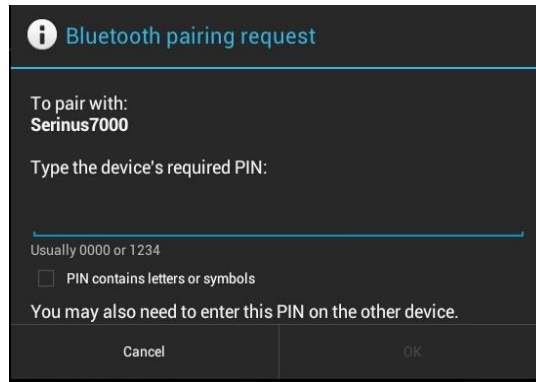

Figure 103 – Bluetooth Pairing Request

5. A screen shot of the instrument's current screen should appear on the users smartphone or tablet. To disconnect press the back key/button on the device.

Note: Once the instrument has been paired with the device it will appear under “Paired Devices” and the PIN will not need to be entered again. Only one Bluetooth connection can be made to an instrument at any one time.

4.7.3 Instrument Control

Once connected the user has full control of the instrument. The range for remote control depends on the device's Bluetooth capabilities and any intervening obstructions, but is usually up to 30 meters.

Remote Screen Operation

With the exception of the number pad, all button functions/actions can be performed by touching the screen. This includes the selection buttons and the scroll buttons. Touching any part of the screen where there is not already a button also enacts the functions of the scroll buttons.

Home Screen

Touching the upper half of the screen increases the contrast and touching the lower half of the screen decreases contrast on the real instrument.

Menus

Touching the upper or lower half of the screen allows the user to scroll up and down respectively.

Right-hand Section of the Screen

Swiping from right to left brings up the number pad for entering numbers (swipe from left to right to hide the number pad).

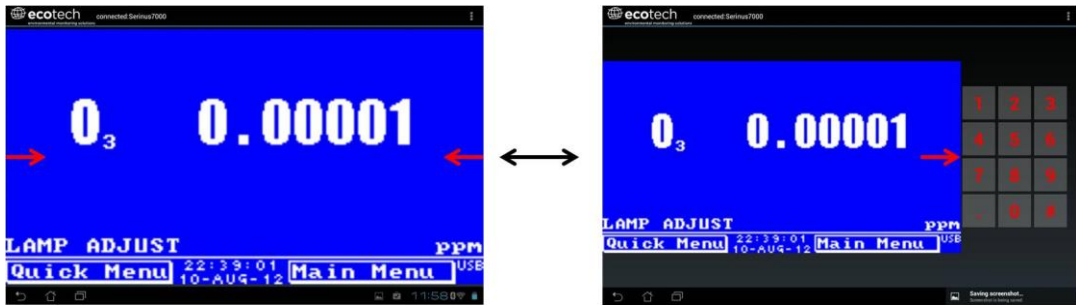

Figure 104 – Showing or Hiding the NumPad

Left-hand Section of the Screen

Swiping from left to right brings up a list of available analysers (swipe from right to left to hide the instrument list).

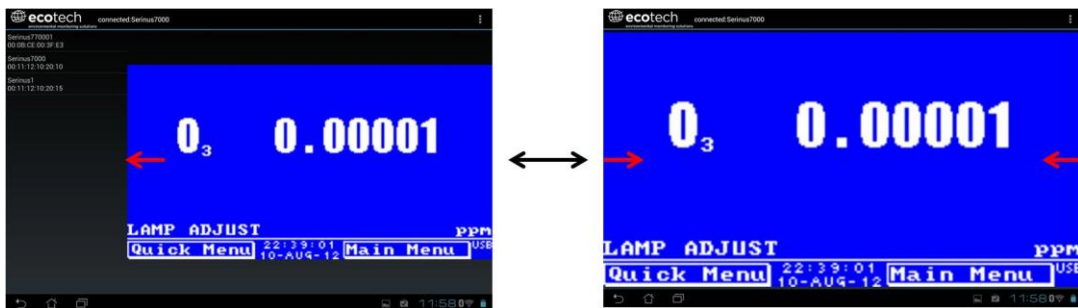

Figure 105 – Switching Analysers

Back Button

This button will enable the user to return to the selection screen, allowing connection to a different instrument.

Options Menu

The Options Menu is accessed by the grey button in the top right corner of the screen or pressing the Menu Button, depending on the users Android device.

Refresh	Refresh the display.
Show/Hide NumPad	Show or hide the number pad.
Real Time Plot	Refer to Section 4.7.4.
Download	Refer to Section 4.7.5.
Get Parameters	Refer to Section 4.7.6.
Preferences	Refer to Section 4.7.7.

4.7.4 Real-Time Plot

Allows the user to view real-time plotting of up to four parameters at the same time. The user can also scroll from left to right, top to bottom or zoom in and out on the plot by swiping/pinching.

Once the plot is zoomed or scrolled, it enters into Observer Mode, meaning that auto-scaling is suspended. Press at the top of the screen (where it says Observer Mode) to return to Normal Mode.

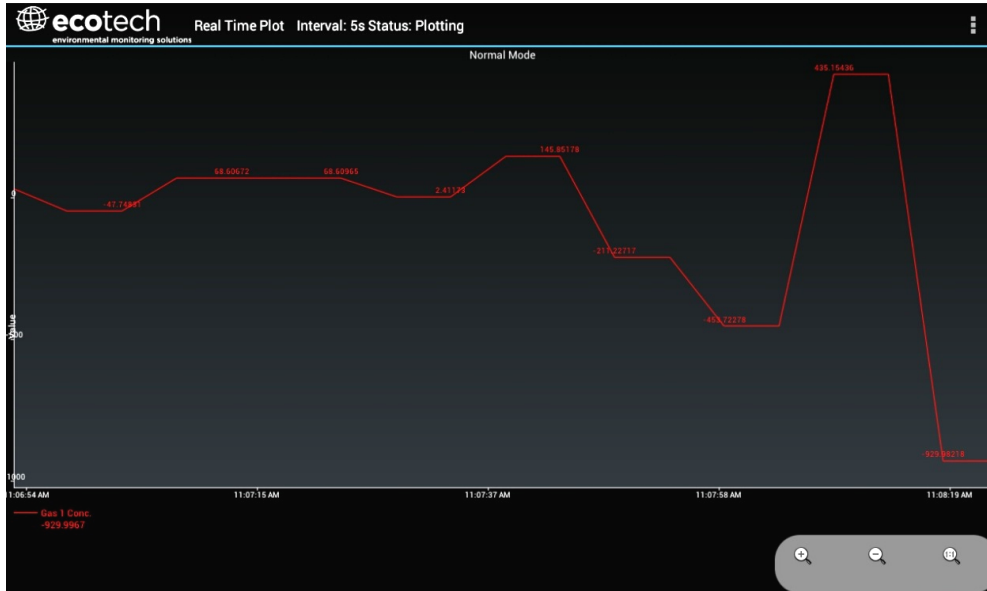

Figure 106 – Real-Time Plot

Options Menu

The Options Menu is accessed by the grey button in the top right corner of the screen or pressing the menu button, depending on the user’s Android device.

Start	Restarts graphing if it has been stopped and returns the graph to Normal Mode .
Stop	Stops collecting data. In this mode the user can scroll the display without going into Observer Mode , because the system has no data collection to suspend. It is necessary to “Stop” data collection to set the interval.
Clear	Clears the window and restarts the graphing.
Save	Saves an image of the graph and accompanying data in the location specified in preferences (refer to Section 4.7.7). The user will also be asked whether they want to send the file and data via email. When saving the data, the user can choose to Save All Data or Customise the length of the data by entering a time between 5 minutes and 6 hours. Only the data from the start of collection to that limit will be saved (although the plot will still appear exactly as it does on the screen).
Set Interval	While data collection is stopped, the user can specify the time intervals between collections.

4.7.5 Download

Download logged data from the USB memory stick inside the instrument. All data logged by the instrument to the USB memory stick over the period of time specified will be collected. Due to the slow connection speed of Bluetooth, this should only be used for relatively short sections of data. Downloading one days' worth of 1 minute data is likely to take a couple of minutes.

Options Menu

Save	Generates a filename based on the start and end date/time specified. It saves the downloaded data in the location specified in preferences and asks to send the saved comma separated text file (.csv) as an attachment to an email. This file format does not include the parameter headings, just the values.
Send E-Mail	Sends an email with the parameter data in the body of the email, formatted as displayed (this includes the parameter name and the values).
Plot	Graphs the data that has been downloaded. The user is prompted to select which parameters to plot based on the parameters that were being logged (refer to Figure 107).
Preferences	Refer to Section 4.7.7.

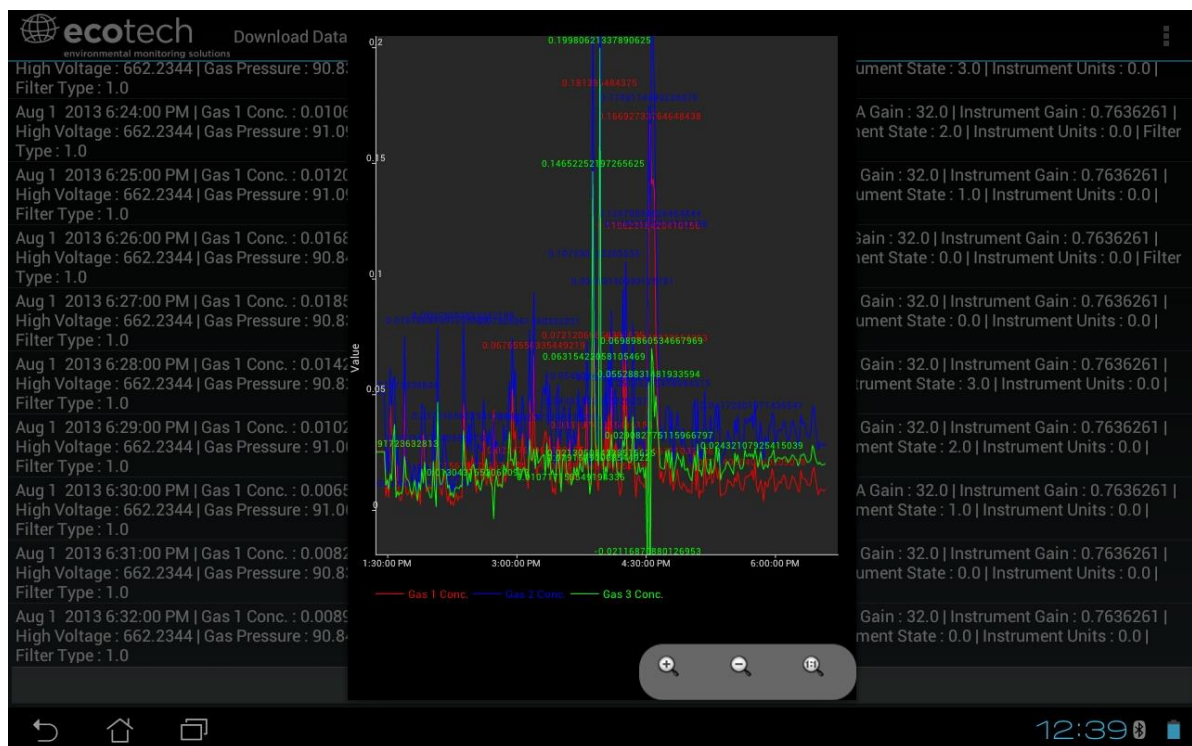

Figure 107 – Plot of Downloaded Data

4.7.6 Get Parameters

Download a list of parameters and corresponding values directly from the instrument. This list of parameters is a snap shot of the current instrument state and is very helpful in diagnosing any problems with the instrument.

Options Menu

Get Parameters	Refreshes the parameter list display.
Save	Generates a filename from the current date and time, saves the parameter data in the location specified in preferences and asks to send the saved text file as an attachment to an email.
Send E-Mail	Sends an email with the parameter data in the body of the email, formatted as displayed.
Preferences	Refer to Section 4.7.7.

4.7.7 Preferences

The Preferences Menu allows the user to adjust the directory settings, logged data format and the colour scheme settings. It can be accessed through the **Options Menu** in most windows.

Directory Settings

The operator can specify/select where to save the parameter lists, logged data and real time plots.

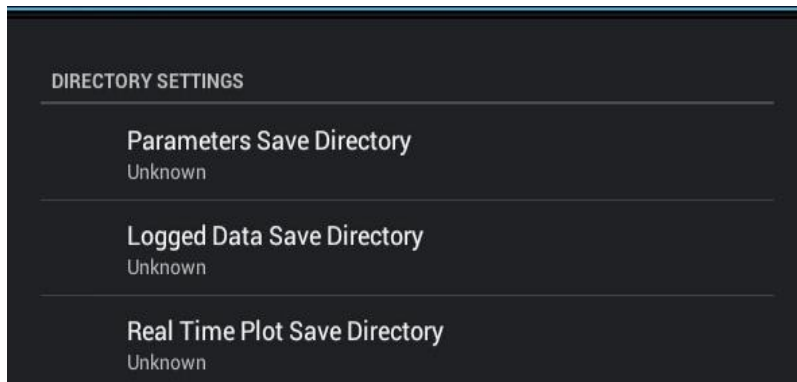

Figure 108 – Directory Settings

Logs Format

When downloading logged data, the parameters can be displayed on one line or each parameter on a separate line.

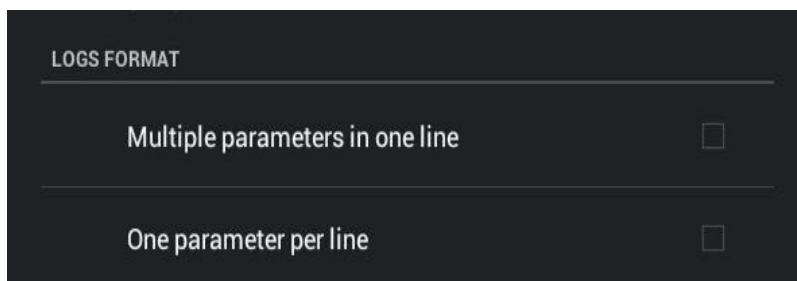

Figure 109 – Logs Format

Colour Theme Settings

Allows the user to choose a colour scheme for the remote screen: Matrix, Classic, Emacs or Custom.

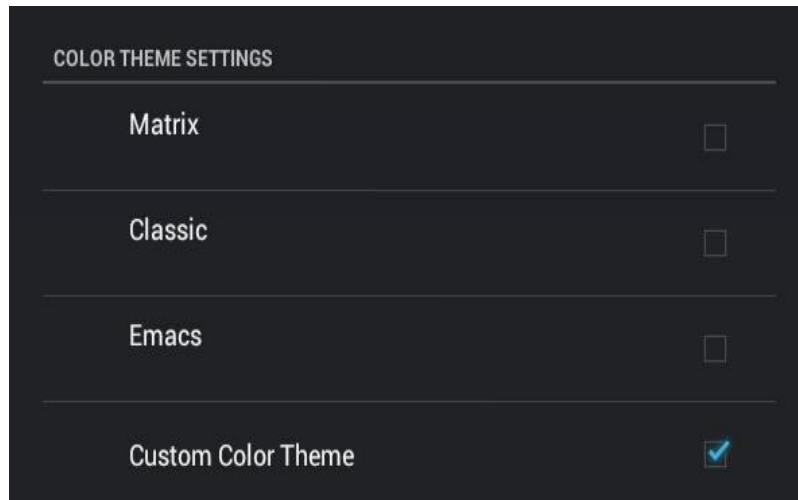

Figure 110 – Colour Theme Settings

This page is intentionally blank.

5. Calibration

The following sections describe how to calibrate the span and zero points of the instrument as well as giving a brief overview of the calibration system.

Main Menu → Calibration Menu (refer to Section 3.4.10 for information on menu items).

5.1 Overview

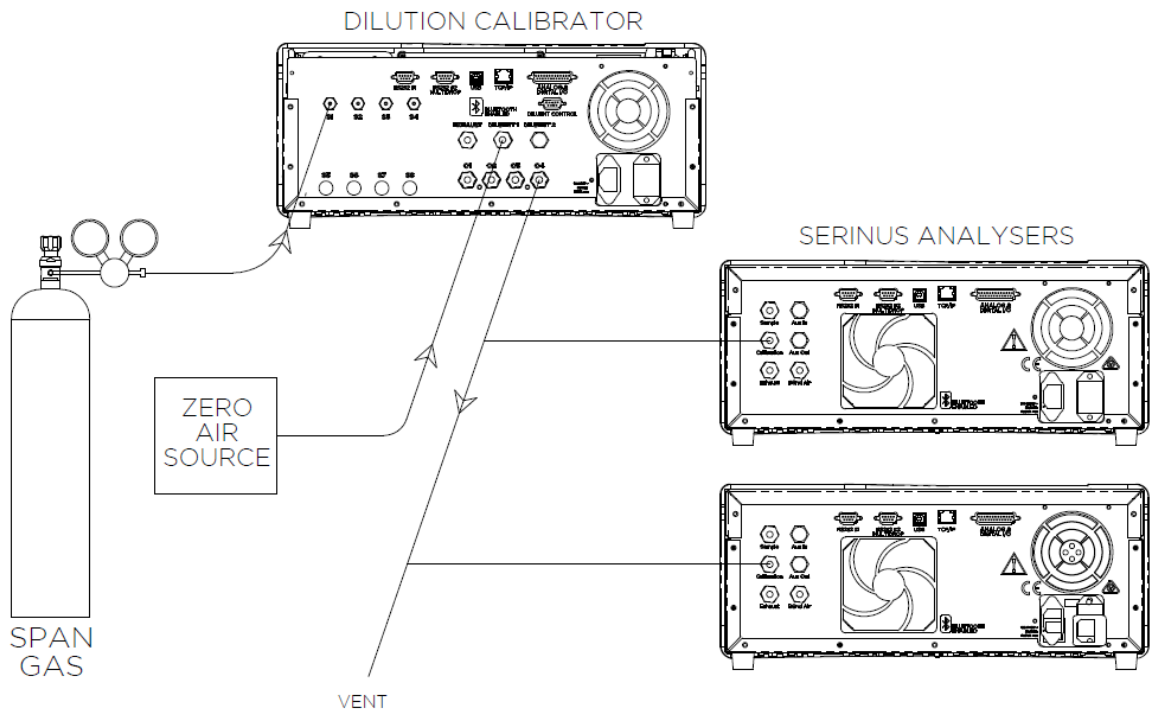

Figure 111 – Example of a Calibration System



CAUTION

All calibration gases must be supplied at ambient pressure to avoid damaging the instrument. If direct gas cylinder connection is required, high pressure Zero/Span options can be installed at time of ordering.

The calibration chapter consists of a:

- General discussion of calibration.
- Description of the pressure calibration procedure.
- Description of the Zero/Span precision check and calibration procedures.
- Description of the multipoint precision check procedure.

The Serinus 30 analyser is a precision measuring device which must be calibrated against a known source of CO (e.g. a certified gas cylinder).

There are several different types of checks/calibrations performed:

- Level 1 Calibration – A simplified two-point instrument calibration used when instrument linearity does not need to be checked or verified. This check is typically performed on a monthly basis. Adjustments to the instrument response can only be made when performing level 1 calibration.
- Level 2 Calibration – A simple check of the instrument's response. Level 2 checks may be performed using non-certified reference sources and are most often used as a performance monitoring tool. The instrument may not be adjusted
- Multipoint precision check – A series of calibration points, typically covering zero and 5 up-scale points, measured using a certified reference atmosphere and covering the instruments FS measurement range. These precision checks are used to determine the linearity of the instrument response across its measurement range.

In general terms, the calibration process includes the following steps:

1. Establish a reliable and stable calibration source.
2. Provide a satisfactory connection between the calibration source and the instrument.
3. Calibrate the instrument against the calibration source.

Multipoint precision check is used to establish the relationship between instrument response and pollutant concentration over the instrument's full scale range. Zero and span calibrations are frequently used to provide a two-point calibration or an indication of instrument stability and function.

Note: Zero calibrations are not recommended by Ecotech, but may be performed when specifically required by a user. Zero calibrations tend to mask issues that should be addressed during maintenance/service.

Regulations generally require that the instrument be span calibrated any time:

- The instrument is moved.
- The instrument is serviced.
- When changing the instruments units between volumetric and gravimetric.
- Whenever the instrument characteristics may have changed.

Regulatory agencies establish the time intervals at which the instrument must be calibrated to ensure satisfactory data for their purposes.

Note: Use of the Serinus 30 analyser as a U.S. EPA or EN-designated equivalent method requires periodic multipoint precision checks in accordance with the procedure described below. In addition, the instrument must be set to the parameters indicated in U.S. EPA (refer to Section 2.4) or EN Equivalent Set-up (refer to Section 2.5).

5.2 Pressure Calibration

The pressure sensors are a vital component of the instrument operation. The pressure calibration should be checked on installation or whenever maintenance is performed.

A thorough leak check must be performed prior to performing a pressure calibration (refer to Section 6.4.4).

The pressure calibration can either be a two-point calibration (one point under vacuum and the other at ambient pressure) or a single ambient point calibration (when very minor adjustments are required).

Note: Ensure that the instrument has been running for at least one hour before any calibration is performed to ensure the instrument's stability. When performing a two-point pressure calibration, it is advisable to perform the vacuum pressure calibration first.

5.2.1 Full Pressure Calibration (Two Point Calibration)

This section outlines how to perform a full pressure calibration. Using the required equipment follow the steps below to complete a full pressure calibration.

Note: Ensure that the instrument has been running for at least one hour before the calibration is performed.

Note: Ensure units of measure are the same on both the barometer and instrument.

Equipment Required

- Barometer
- Vacuum source

Procedure

1. Turn OFF the vacuum source and allow the instrument to return to ambient pressure.
2. Disconnect any external tubing connected to the rear of the instrument.
3. Open - **Main Menu** → **Calibration Menu** → **Pressure Calibration Menu** - (read note) - OK.

Note: This action will place the valve sequencing on hold; normal sampling will be interrupted.

4. Edit - **Vacuum Set Pt.** - (Read displayed instructions) - OK.
5. Refer to Figure 112. Connect a barometer to the **Sample Port**.

6. Refer to Figure 112. Connect a vacuum source to **Exhaust Port** of the instrument.

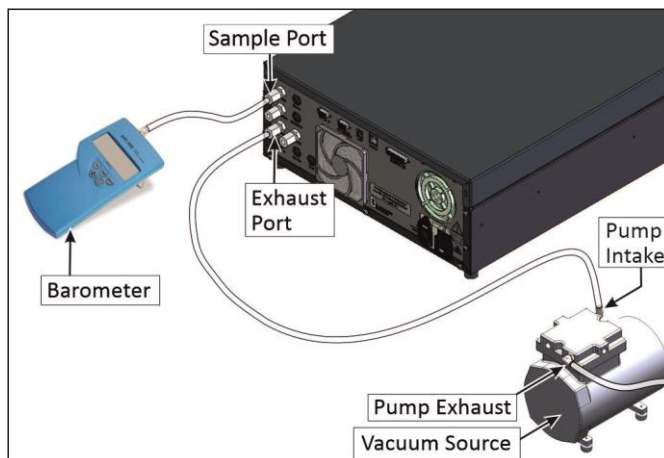

Figure 112 – Full Pressure Calibration Set-up

7. Wait 2 - 5 minutes and ensure the pressure reading on the barometer has dropped and is stable.
8. Enter the barometer reading into the instrument - Accept.
9. Read displayed instructions - OK.
10. Turn OFF the vacuum source and wait 1 min or until the barometer reads ambient pressure.
11. Refer to Figure 113. Disconnect the vacuum source and barometer from **Exhaust Port** and **Sample Port**.

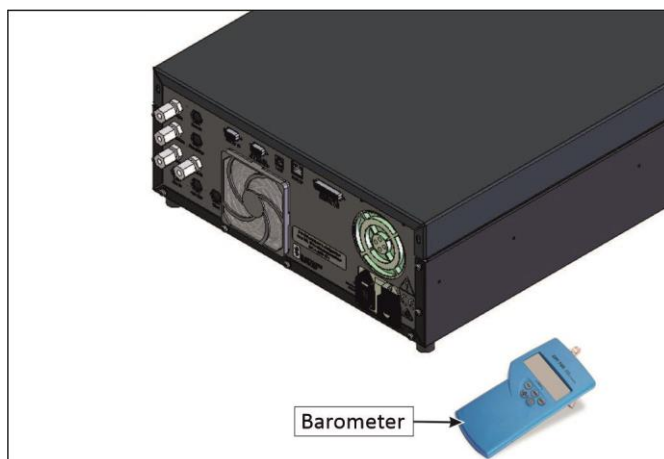

Figure 113 – Full Pressure Calibration Set-up (Ambient)

12. Wait 2 - 5 min, enter the ambient barometer reading into the instrument - Accept.

Note: Both cell and ambient pressure sensors should now be displaying the current ambient pressure and they should be the same value within 3 torr of each other.

13. Back - **Pressure Calibration Menu** - (read note) - OK.

5.2.2 Pressure Calibration (Ambient Only)

Full pressure calibrations are generally recommended, however it is possible to calibrate only the ambient point in cases where only a minor ambient pressure adjustment is required.

Note: Ensure that the instrument has been running for at least one hour before any calibration is performed to ensure the instrument's stability.

Note: Ensure units of measure are the same on both the barometer and instrument.

Equipment Required

- Barometer

Procedure

1. Turn OFF the vacuum source and allow the instrument to return to ambient pressure.
2. Refer to Figure 114. Disconnect any external tubing connected to the rear of the instrument.
3. Open - **Main Menu** → **Calibration Menu** → **Pressure Calibration Menu** - (read note) - OK.

Note: This action will place the valve sequence on hold; normal sampling will be interrupted.

4. Edit - **Ambient Set Pt.** - (Read displayed instructions) - OK.

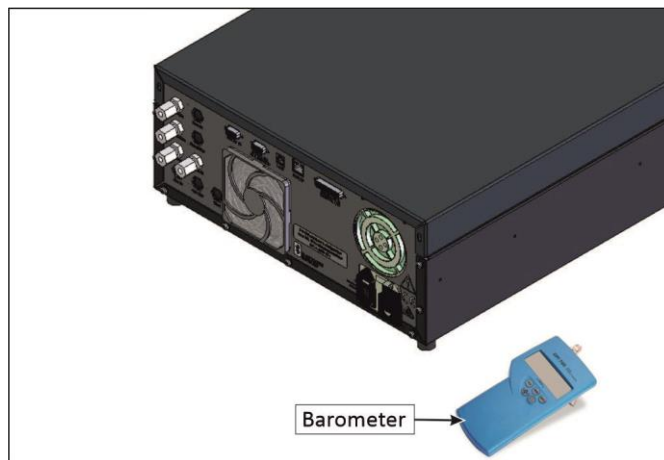

Figure 114 – Ambient Pressure Calibration Set-up

5. Wait 2 - 5 minutes and enter the ambient barometer reading into the instrument - Accept.

Note: Both cell and ambient pressure sensors should now be displaying the current ambient pressure and they should be the same value within 3 torr of each other.

6. Back - **Pressure Calibration Menu** - (read note) - OK.

5.2.3 Pressure Calibration (Internal Pump Option Only)

The internal pump requires a separate pressure calibration procedure that replaces the one used in Section 5.2.1 and 5.2.2.

Note: Ensure that the instrument has been running for at least one hour before any calibration is performed to ensure sufficient stability.

Note: Ensure units of measure are the same on both the barometer and instrument.

Equipment Required

- Barometer

Procedure

1. Disconnect any external tubing connected to the rear of the instrument.
2. Open - **Main Menu** → **Calibration Menu** → **Pressure Calibration** - (read displayed note) - OK.

Note: Entering this menu will switch OFF the internal pump and place the valve sequencing on hold; normal sampling will be interrupted.

3. Refer to Figure 115. Connect a barometer to the **Sample Port**.

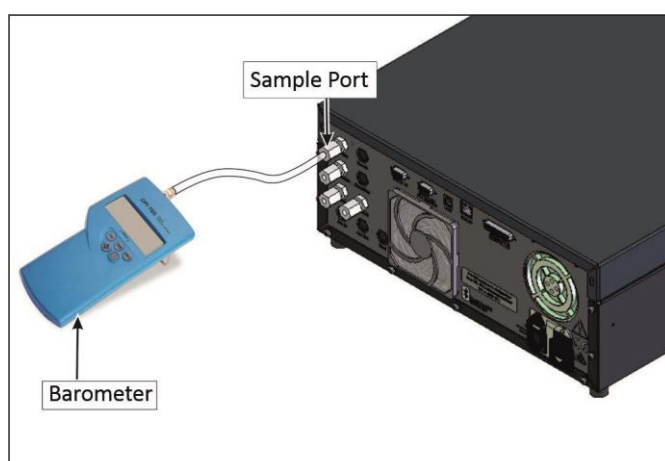

Figure 115 – Pressure Calibration (Internal Pump Option Only) Set-up

4. Edit - **Vacuum Set Point** - (read displayed instruction) - OK.
5. Wait 2 - 5 minutes and ensure the pressure reading on the barometer is stable.
6. Enter the barometer reading into the instrument - Accept.
7. Read displayed instructions - OK.
8. The pump should now stop automatically. Disconnect the barometer from the **Sample Port**.
9. Wait 2 - 5 minutes and enter the ambient barometer reading into the instrument - Accept.

Note: Both cell and ambient pressure sensors should now be displaying the current ambient pressure and they should be the same value within 3 torr of each other.

10. Back - **Pressure Calibration Menu** - (read note) - OK.

5.3 Manual Background

A background is a measurement that is made when CO free air is drawn through the reaction cell. The resulting measurement signal (background) will include signals unrelated to CO. The background is an electronic baseline, it is normally run every 24 hours automatically. There is sometimes a need for the user to run a manual background.

Note: A manual background is recommended before commencing a multipoint precision check.

Equipment Required

- N/A

Procedure

1. Open - **Main Menu** → **Calibration Menu**.
2. Start - **Manual Background** → **Running**.
3. Manual background will now display running and will proceed to draw air from the CO-CO₂ converter for 4 minutes (3 minutes of fill time and 1 minute of measure). The user can press stop at any time to cancel the background. At the end of the 4 minute period a new background voltage will be recorded in the event log as well as in the **Calculation Factors Menu**.

5.4 Zero Calibration

Zero calibrations are used to determine the zero response of the instrument and apply an offset to the reading.

Performing a zero calibration will adjust the **Zero Offset CO**. This offset can be checked in the **Main Menu** → **Service Menu** → **Calculation Factors Menu** and should be very close to zero. A large offset may indicate a problem with the instrument (refer to Section 7).

Note: Ecotech encourages regular zero precision checks; however Ecotech recommends that the zero calibration only be performed when specifically required as it may mask issues that should be addressed during maintenance/service.

A zero calibration can be performed either through the **Calibration Port**, **Background Air Port** or the **Sample Port**. Refer to the instructions outlined in the next three sections:

Note: Ensure the instrument has been running for at least one hour before any calibration is performed to ensure sufficient stability.

5.4.1 Calibration Port

Equipment Required

- Zero Air Source (refer to Section for 1.3 definition)

Procedure

1. Refer to Figure 116. Ensure a suitable zero air source is connected to the **Calibration port**.

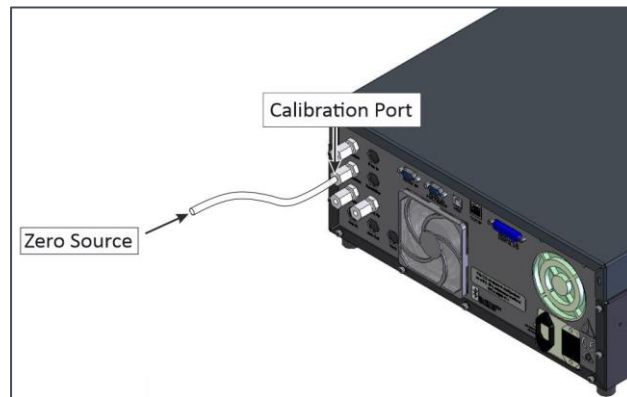

Figure 116 – Zero Calibration Set-up - 1

2. Open - **Main Menu** → **Calibration Menu**.
3. Select - **Cal. Type** → **Manual** - Accept.
4. Select - **Cal. Mode** → **Zero** - Accept.
5. Select - **Zero Source** → **External** - Accept.
6. Allow the instrument time to achieve a stable response.
7. Enter - **Zero Calibrate CO** - (read note) - OK.
8. Select - **Cal. Mode** → **Measure** - Accept (To return to sample measure).

5.4.2 Sample Port

Equipment Required

- Zero Air Source (refer to Section for 1.3 for definition)

Procedure

1. Refer to Figure 117. Ensure a suitable zero air source is connected to the **Sample Port**.

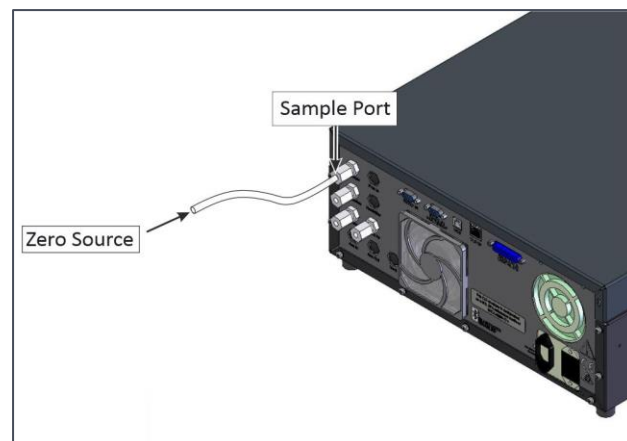

Figure 117 – Zero Calibration Set-up - 2

-
2. Open - **Main Menu** → **Calibration Menu**.
 3. Select - **Cal. Type** → **Manual** - Accept.
 4. Select - **Cal. Mode** → **Measure** - Accept.
 5. Select - **Zero Source** → **External** - Accept.
 6. Allow the instrument time to achieve a stable response.
 7. Enter - **Zero Calibrate CO** - (read note) - OK.
 8. Disconnect the zero air source and reconnect the sample line to the **Sample Port**.

5.4.3 Background Air Port

Equipment Required

- N/A

Procedure

1. Open - **Main Menu** → **Calibration Menu**.
2. Select - **Cal. Type** → **Manual** - Accept.
3. Select - **Cal. Mode** → **Zero** - Accept.
4. Select - **Zero Source** → **Internal** - Accept.
5. Allow the instrument time to achieve a stable response.
6. Enter - **Zero Calibrate CO** - (read note) - OK.
7. Select - **Cal. Mode** → **Measure** - Accept (To return to sample measure).

5.5 Span Calibration

A span calibration is a calibration performed at the upper end of the instrument's measurement range. Ecotech recommends calibration at 80% of the full scale measurement or operating range of the instrument.

While the instrument range is commonly set as a default 0 - 50 ppm, this is widely recognised as no longer being valid with modern digital communication and most regulators will now recommend a range more suited to local conditions.

A span gas can be supplied through either the **Calibration Port** or **Sample Port**. Refer to the instructions outlined in the next two sections.

Note: Ensure that the instrument has been running for at least one hour before any calibration is performed to ensure sufficient stability.

5.5.1 Calibration Port

Equipment Required

- Span source

Procedure

1. Refer to Figure 118. Ensure a suitable span source is connected to the **Calibration Port**.

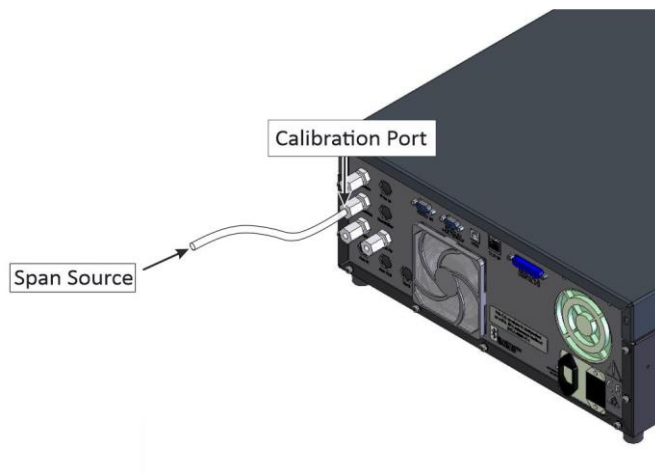

Figure 118 – Span Calibration Set-up - 1

2. If diluting the gas with a dilution calibrator, set the output concentration to 80% of the instrument measurement range.
3. Open - **Main Menu** → **Calibration Menu**.
4. Select - **Cal. Type** → **Manual** - Accept.
5. Select - **Cal. Mode** → **Span** - Accept.
6. Let the instrument stabilise, typically 15 minutes.
7. Enter - **Span Calibrate CO** - (Enter the span output concentration) - Accept.
8. Select - **Cal. Mode** → **Measure** - Accept (To return to sample measure).

5.5.2 Sample Port

Equipment Required

- Span source

Procedure

1. Refer to Figure 119. Ensure suitable span source is connected to the **Sample Port**.

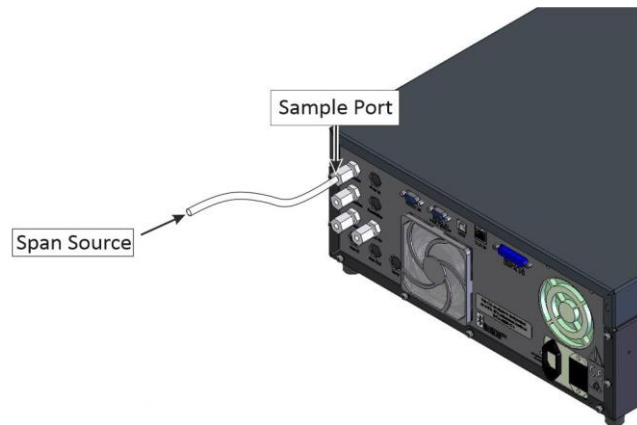

Figure 119 – Span Calibration Set-up - 2

2. If diluting the gas with a dilution calibrator, set the output concentration to 80% of the instrument measurement range.
3. Open - **Main Menu** → **Calibration Menu**.
4. Select - **Cal. Type** → **Manual** - Accept.
5. Select - **Cal. Mode** → **Measure** - Accept.
6. Let the instrument stabilise, typically 15 minutes.
7. Enter - **Span Calibrate CO** - (Enter the span output concentration) - Accept.
8. Disconnect the span source and reconnect the sample line to the **Sample Port**.

5.5.3 Manual Instrument Gain and Offset Adjustments



CAUTION

Manual adjustment of the Instrument Gain does not take into account the PTF correction and can lead to an incorrect calibration

At times it may be desirable to manually adjust the instrument's gain and offset. Typically this option is only used when an instrument calibration has been corrupted and the user wishes to reset the instrument response factors prior to performing a new calibration.

To manually adjust the instrument follow the below procedure:

1. Open - **Main Menu** → **Service Menu** → **Calculation Factors Menu**.
2. Edit - **Instrument Gain** - (Adjust as required, 1 is the default) - Accept.
3. Edit - **Zero Offset CO** - (Adjust as required, 0 is the default) - Accept.

5.6 Precision Check

Similar to a normal zero or span calibration, a precision check is a Level 2 calibration that may be performed using a non-certified reference. The instrument is supplied with a known concentration of span gas (or zero air) and the instrument's response observed. However, no adjustment to the instrument response is made during a precision check.

Note: Ensure that the instrument has been running for at least one hour before any calibration is performed to ensure sufficient stability.

A precision check can be performed either manually via the **Sample Port**, **Calibration Port** or **Background Port** (Zero Only) or can also be performed automatically using the Timed Mode (refer to Section 3.4.10.2).

Equipment Required

- Span source
- Zero source

Procedure

1. Supply the instrument with a zero source (refer to Section 5.4 for the procedure of setting up a zero, but do not do a **Zero Calibrate CO**, and continue following below steps).
2. Observe and record the measurement from the instrument.
3. Supply the instrument with a span source (refer to Section 5.5 for the procedure of setting up a span but do not do a **Span Calibrate CO**).
4. Observe and record the measurement from the instrument.
5. Check both readings against user local applicable standards.
6. Select - **Cal. Mode** → **Measure** - Accept (To return to sample measure).

If an instrument fails a span precision check (based on the users local applicable standards), perform a span calibration (refer to Section 5.5).

If an instrument fails a zero precision check (based on the users local applicable standards), resolve the issue by referring to Section 7 **Zero Drift**.

5.7 Multipoint Precision Check

A multipoint precision check is used to determine the linear response of the instrument across its operating range. The instrument is supplied with span gas at multiple known concentrations, typically a zero point and at least five up-scale points, spread across the operating range of the instrument. The observed concentrations are compared to expected values and the linearity of the instrument assessed against local applicable standards.

Note: The instrument is inherently linear and the instrument gain should **not** be adjusted at each individual point. Non-linearity indicates a problem with the instrument (refer to Section 7). Ensure that the instrument has been running for at least one hour before any calibration is performed to ensure sufficient stability.

Several methods for producing multiple known concentrations are available to use, such as connecting multiple certified gas cylinders at different concentrations. However, Ecotech strongly recommends the use of a dilution calibrator and a certified cylinder of CO at an appropriate concentration.

1. Connect your calibration system to the **Calibration Port** of the instrument (Ecotech recommends the Serinus Cal 1000 as a minimum, refer to Figure 111).
2. Generate and record the displayed span concentrations for (at least) six stepped points (of known concentrations) evenly spaced across the instruments measurement range (refer to the example below).
3. Then using a program such as MS Excel, create an X Y scatter plot of expected concentration versus the recorded instrument response and use linear regression to calculate the line of best fit and the correlation factor (R^2) – refer to the users local applicable standards.

Example for an instrument measurement range of 75 ppm:

- a. For the 1st concentration, set the gas dilution calibrator to supply **60 ppm** CO gas to the instrument.
- b. Allow the instrument to sample the calibration gas until a prolonged stable response is achieved (the amount of time this takes is impacted by the calibration setup). Record the instrument response.
- c. Repeat the above steps using concentrations of **50 ppm, 30 ppm, 20 ppm, 10 ppm** and a **Zero** point.

Note: To highlight hysteresis errors, it is advisable to run the multipoint check in both descending and ascending order - refer to applicable local standards.

- d. Graph the results and use linear regression to determine a pass or fail as per the user applicable local standards.
4. The linear regression equation will be displayed.

$$y = mx + c$$

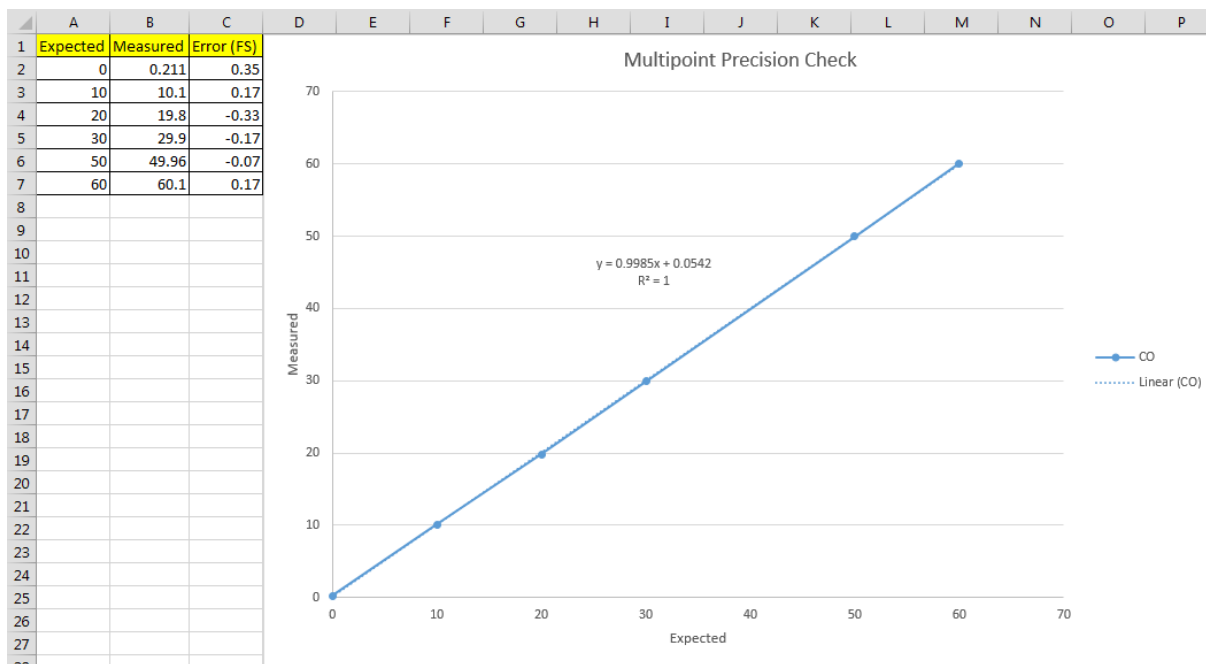

Figure 120 – Excel Graph of Multipoint Precision Check

5. The following is a guide to approximate expected good results.
 - a. The gradient (m) falls between 0.98 and 1.02.
 - b. The intercept (b) lies between -2 and +2.
 - c. The correlation (R^2) is greater than 0.99.
6. If unsatisfactory results are observed refer to Section 7.

5.8 Flow Calibration (Internal Pump Option Only)

This procedure calibrates the rate of the flow generated by the internal pump. The following procedure must be performed if the instrument:

- After a service or repair.
- When the external flow check has found the flow to be outside normal range.
- When a new pump has been installed.
- When the instrument is reset to factory defaults.

Equipment Required

- Calibrated Flow Meter

Procedure

1. Disconnect any external tubing connected to the rear ports of the instrument (**Sample Port**, **Exhaust Port**, etc.).
2. Open - **Main Menu** → **Calibration Menu** → **Flow Calibration Menu**.
3. Select - **Pump Control** → **MANUAL** - Accept.

-
4. Off - **Internal Pump** → **Off**.
 5. Wait for the **Sample Flow** to become stable around 0 (± 0.01 slpm).
 6. Set - **Cal. Zero** - Yes (Calibration of your zero point).
 7. Connect a calibrated flow meter to the Sample Port.
 8. On - **Internal Pump** → **On**.
 9. Edit the **Coarse** and **Fine** pots until the flow meter reads the desired instrument **Sample Flow** rate (**Set Point**).

Note: Adjust the **Fine** pot to 253, adjust the **Coarse** to be as close as possible to desired reading and use **Fine** pot to make it exact.

10. Edit - **Cal. Point** - (Enter the reading from the flow meter) - Accept.
11. Select - **Pump Control** → **START** - Accept.
12. Leave for up to 5 minutes to return to normal operation. If instrument doesn't return to normal there may be a blockage (refer to Section 7).
13. Remove flow meter and reconnect external tubing.
14. Back - **Flow Calibration Menu** - (Read note) - OK.

5.9 High Pressure Zero/Span Valve (Option)

If the instrument was ordered with this option, the internal pressurised calibration valves will already be installed within the instrument as either a zero or span calibration source, thus no other internal connections need to be made.

Note: Before using a high pressure span or zero as a source for calibrating the instrument, check the local regulatory requirements. This is generally only be used as an operational check of the instrument's zero point and single span point (recommended as 80% of full scale).

5.9.1 Single Pressurised Calibration Option

Set-Up of Single Calibration Option

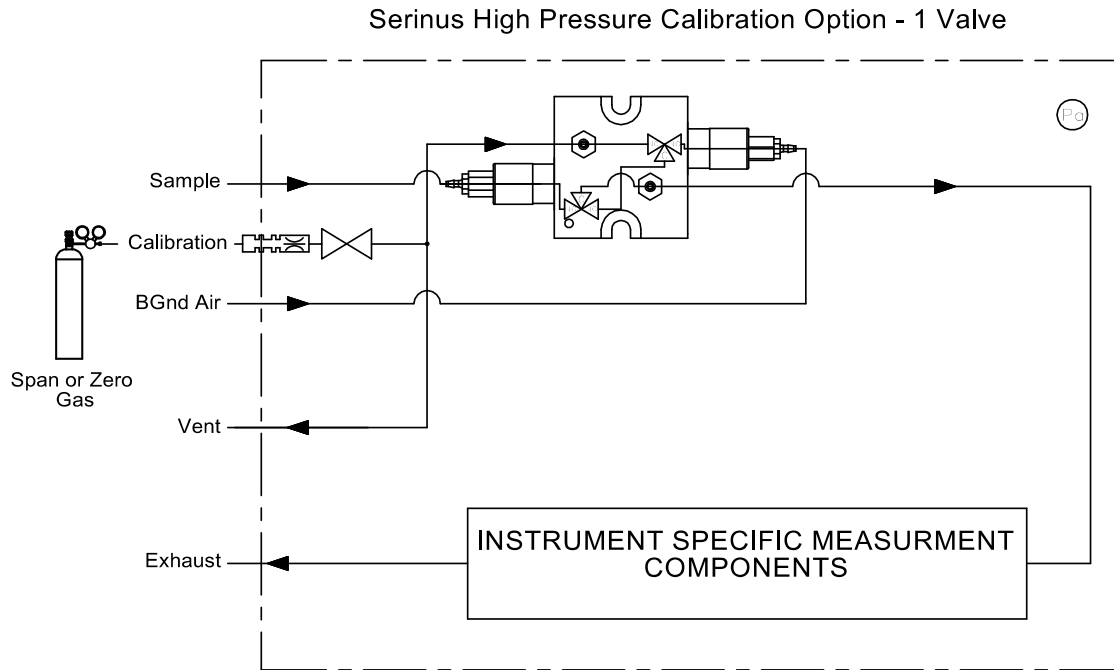

Figure 121 – Single High Pressure Calibration Option

When using the pressurised calibration option, either a high pressure zero or span cylinder (depending on the option ordered) should be connected to the **Calibration Port**.

Equipment Required

- Calibrated Flow Meter
- Gas Cylinder and Accessories

Procedure

1. Ensure the gas cylinder is fitted with an appropriate gas regulator with a shut off valve.
2. Connect a 1/4" line of stainless steel tubing between the gas cylinder and the instruments **Calibration Port**.

Note: This connection may need to be retightened during this operation.

3. Open the cylinder main valve and adjust the regulator to 15 psig.
4. Open the regulator's shutoff valve and test for leaks:
 - a. Pressurise the line.
 - b. Close the cylinder main valve.
 - c. If pressure drops by more than 2 PSI over 5 minutes, check the connections and retest.
 - d. Open cylinder main valve.
5. Temporarily place a flow meter on the **Vent Port**.

6. Open - **Main Menu** → **Calibration Menu**.
7. Select - **Cal. Type** → **Manual** - Accept.
8. Select - **Cal. Mode** → **Span** or **Zero** - Accept (Depending on the option installed).

Note: When using the high pressure zero option, ensure **Zero Source** is set to **External**.

9. Adjust the regulator pressure until the flow meter on the **Vent Port** is between 0.5 and 1 slpm. This is the excess calibration gas.

Note: Do not exceed a pressure of 2 bars, this can damage the instrument and cause gas leakage.

Return to Normal Operation

1. Select - **Cal. Mode** → **Measure** - Accept. (To return to sample measure).
2. Remove the flow meter on the **Vent Port** and connect a vent line.
3. Reconnect the instrument fittings and return to the original set-up.

The instrument is now in normal operation mode. When either zero or span calibration is initiated (depending on which option has been installed) the instrument will automatically open the valves to run a pressurised calibration.

5.9.2 Dual Pressurised Calibration Option

Set-Up of Dual Calibration Option

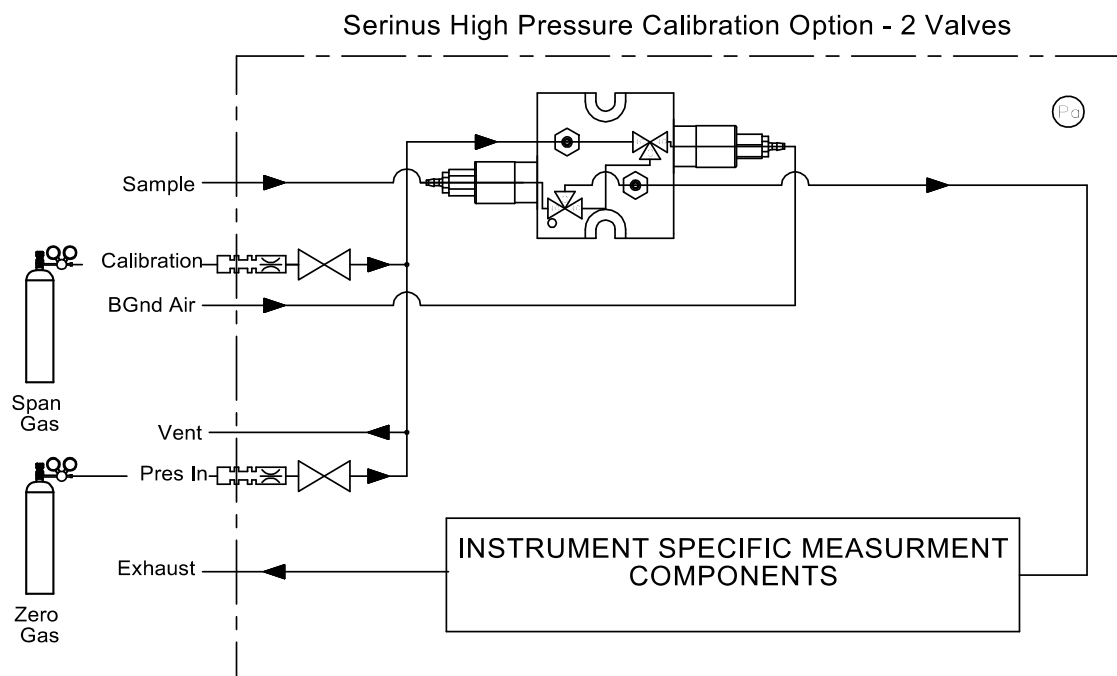

Figure 122 – Dual High Pressure Calibration Option

When using the dual pressurised calibration option, a high pressure zero cylinder should be connected to the **Pres In Port** and a high pressure span cylinder connected to the **Calibration Port**.

Equipment Required

- Calibrated Flow Meter
- Gas Cylinder of Zero air and Accessories
- Gas Cylinder of CO and Accessories

Procedure

1. Ensure the gas cylinder is fitted with an appropriate gas regulator with a shut off valve.
2. Connect a 1/4" line of stainless steel tubing between the appropriate gas cylinders and the instrument's **Pres In Port** and **Calibration Port**.

Note: This connection may need to be retightened during this operation.

3. Open the cylinder main valve and adjust the regulator to 15 psig.
4. Open the regulator's shutoff valve and test for leaks:
 - a. Pressurise the line.
 - b. Close the cylinder main valve.
 - c. If pressure drops by more than 2 PSI over 5 minutes, check the connections and retest.
 - d. Open cylinder main valve.
5. Temporarily place a flow meter on the **Vent Port** (This port is now used as the high pressure calibration vent for both span and zero).
6. Open - **Main Menu** → **Calibration Menu**.
7. Select - **Cal. Type** → **Manual** - Accept.
8. Select - **Cal. Mode** → **Zero** - Accept.

Note: When using the high pressure zero option, ensure **Zero Source** is set to **External**.

9. Adjust the regulator pressure until the flow meter on the **Vent Port** is between 0.5 and 1 slpm. This is the excess calibration gas.

Note: Do not exceed a pressure of two bars, this can damage the instrument and cause gas leakage.

10. Select - **Cal. Mode** → **Span** - Accept.
11. Adjust the regulator pressure until the flow meter on the **Vent Port** is between 0.5 and 1 slpm. This is the excess calibration gas.

Note: Do not exceed a pressure of two bars, this can damage the instrument and cause gas leakage.

Return to Normal Operation

1. Select - **Cal. Mode** → **Measure** - Accept. (To return to sample measure).
2. Remove the flow meter on the **Vent Port** and connect a vent line.
3. Reconnect the instrument fittings and return to the original set-up.

The instrument is now in normal operation mode. When either zero or span calibration is initiated the instrument will automatically open the valves to run a pressurised calibration.

This page is intentionally blank.

6. Service

6.1 Additional Safety Requirements for Service Personnel

In addition to Safety Information stated previously, service personnel are also advised of the following:

- Documentation must be consulted in all cases where caution symbol is marked, in order to find out the nature of the potential hazards and any actions which have to be taken to avoid them, refer to Table 1 – Internationally Recognised Symbols.
- Do not energise the instrument until all conductive cleaning liquids, used on internal components, are dried up.
- Do not replace the detachable mains supply cord with an inadequately rated cord. Any mains supply cord that is used with the instrument must comply with the safety requirements (250 V/10 A minimum requirement).

6.2 Maintenance Tools

To perform general maintenance on the Serinus 30 the user may require the following equipment:

- Customizable Test Equipment Case PN: H070301
- Digital Multimeter & Leads (DMM) E031081 & E031082 PN: E031081 &
- Barometer PN: E031080
- Thermometer & Probe E031079 PN: E031078 &
- Flow Meter (Select Range)
Range: 50 sccm - 5000 sccm PN: ZBI-200-220M
- Minifit Extraction Tool PN: T030001
- Orifice/Sintered Filter Extraction Tool PN: H010046
- Leak Test Jig PN: H050069
- Computer/Laptop and Connection Cable for Diagnostic Tests
- 1.5 mm Hex Key
- Assortment of 1/4" and 1/8" Tubing and Fittings
- Zero Air Source
- Span Gas Source
- General Hand Tools



Figure 123 – Minifit Extraction Tool – (PN: T030001)

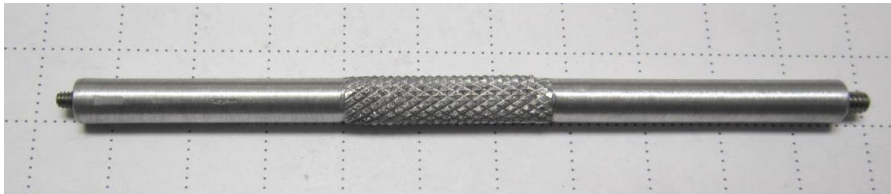

Figure 124 – Orifice/Sintered Filter Removal Tool – (PN: H010046)

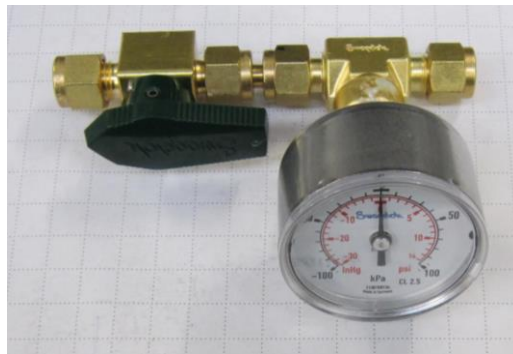

Figure 125 – Leak Test Jig – (PN: H050069)



Figure 126 – Air Monitoring Test Equipment Kit (AMTEK) – Customisable

6.3 Maintenance Schedule

The maintenance intervals are determined by compliance standards that differ in various regions. The following is recommended by Ecotech as a guide. Compliance with local regulatory or international standards is the responsibility of the user.

Table 8 – Maintenance Schedule

Interval *	Task performed	Section
Nightly or Every 5 Days	Perform precision check (Automated)	5.6
	Perform precision check (Manual) (This task is performed to ensure a high data capture rate)	
Monthly	Perform precision check (pre-check) prior to commencing any service tasks or making any changes to the system as found in its current state. This task is necessary to validate any previously captured data.	5.6
	Check particulate filter, replace if full/dirty	6.4.1
	Perform a pressure check	6.4.9
	Check sample inlet system for moisture or foreign materials. Clean if necessary	
	Check chassis fan filter and clean if necessary	6.4.2
	Check event log	3.4.1
	Check date and time is correct	3.4.8
	Check instrument status light	3.3.1
	External vacuum pump check (vacuum source) or Internal pump check	
	Leak check	6.4.4
	Perform span calibration	5.5
6 Monthly	Check the CO-CO ₂ converter	6.4.5
	Perform multipoint precision check	5.7
	Calibrate analog outputs (only if used)	3.4.26
Yearly	Replace DFU filter	6.4.3
	Replace sintered filter	6.4.6 & 9.7
	Check the flow, if incorrect clean or replace the orifice	6.4.6 & 9.7
	Trim pot tuning procedure	6.4.7

* Suggested intervals for maintenance procedure are a guide only and may vary with sampling intensity and/or environmental conditions. Refer to your local regulatory standard for your personalised maintenance schedule.

6.4 Maintenance Procedures

6.4.1 Particulate Filter Replacement

Contamination of the 5-micron filter can result in degraded performance of the instrument, including slow response time, erroneous readings, temperature drift and various other problems. The frequency which the filter needs to be replaced is heavily dependent on the environmental conditions the instrument is sampling.

1. Turn OFF the external pump and allow the instrument to return to ambient.
2. Open the lid of the instrument to access the sample filter holder (located in front right-hand corner).
3. Refer to Figure 127. Remove the Kynar nut from the fitting.

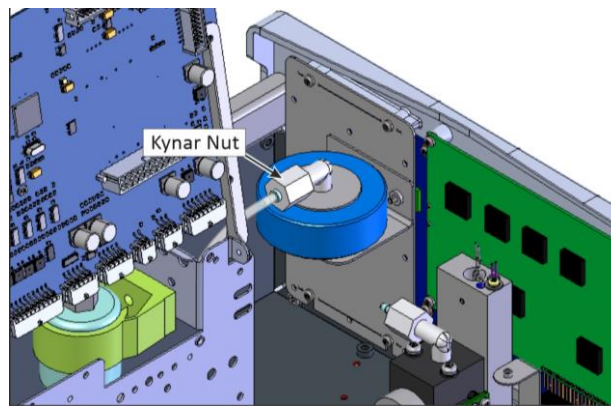

Figure 127 – Remove Kynar Nut

4. Refer to Figure 128. Remove the retaining ring by turning it counter-clockwise.

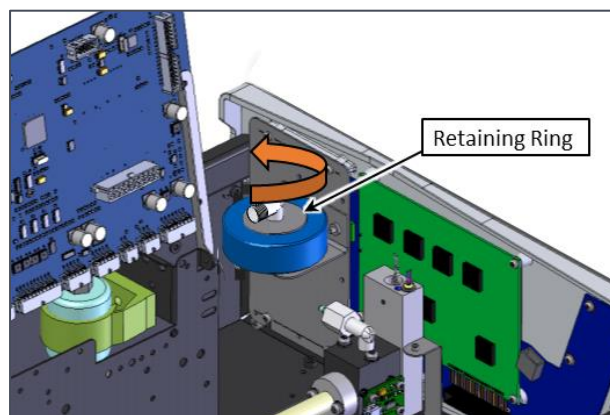

Figure 128 – Remove Retaining Ring

5. Refer to Figure 129. Remove the sample filter holder sealing cap.

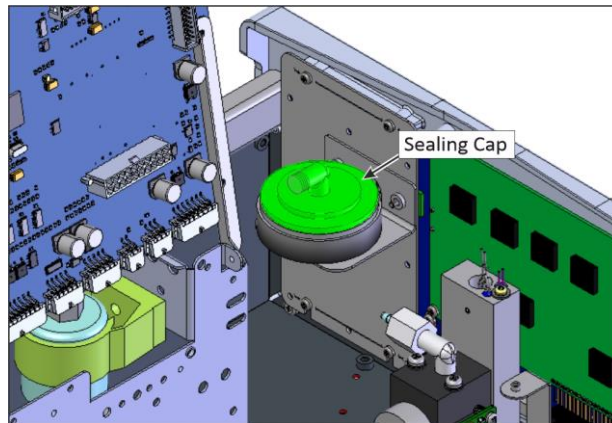

Figure 129 – Remove Filter Sealing Cap

6. Refer to Figure 130. Remove the old particulate filter.

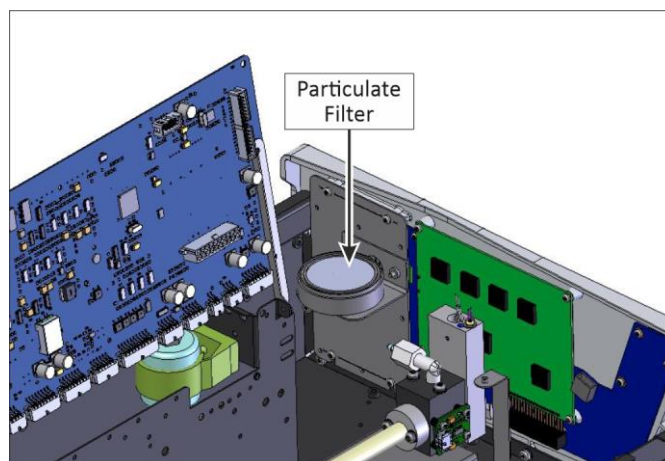

Figure 130 – Particulate Filter

7. If the inner surface of the sample filter components are dirty, then clean with damp lint free paper towel.
8. Place a new particulate filter paper into the body of the sample filter holder.

Note: Make sure filter body is completely dry before placing the new filter.

Note: Avoid to touch Particulate filter paper by hand use blue paper to place the filter into filter body.

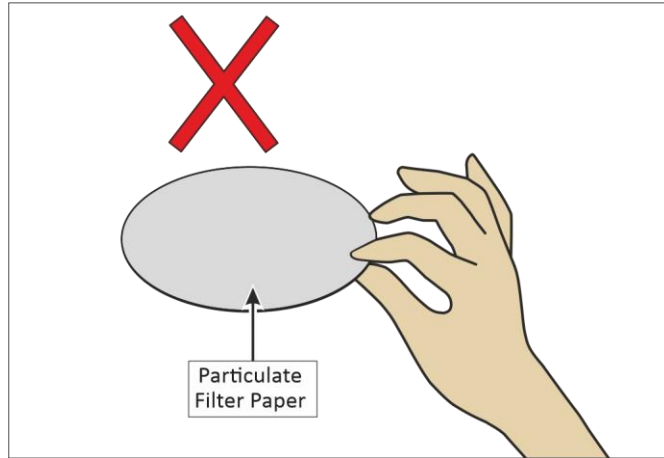

Figure 131 – Avoid touching Particulate Filter Paper

-
9. Replace the sample filter holder sealing cap and re-assembly the retaining ring by turning it clockwise.

Note: Make sure O-ring and particulate filter paper are installed correctly

Note: Make sure that Kynar Elbow Barb Fitting is in the right direction, refer to Figure 132.

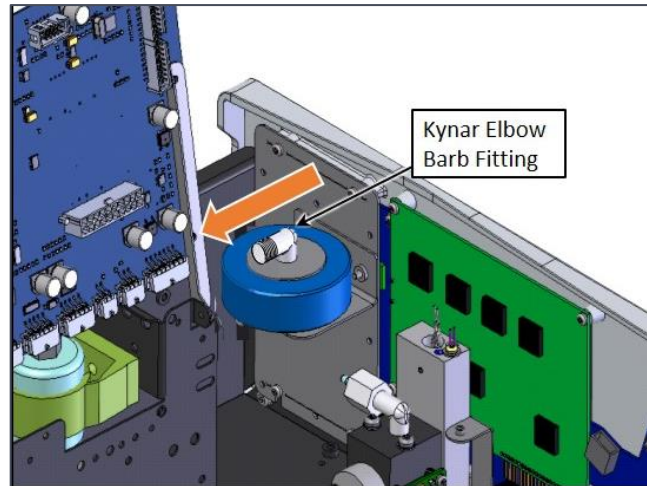

Figure 132 – Kynar Elbow Barb Fitting Direction

10. Reconnect the Kynar nut with barb adapter and tubing to the top of the sample filter holder.
11. Close the lid of the instrument and perform a leak check (refer to Section 6.4.4).

6.4.2 Clean Chassis Fan Filter

The chassis fan filter is located on the rear of the instrument. If this filter becomes contaminated with dust and dirt it may affect the cooling capacity of the instrument.



CAUTION

Do not insert a rod or finger into the cooling fans, otherwise injury may result.

1. Refer to Figure 133. Remove outer filter casing and filter.

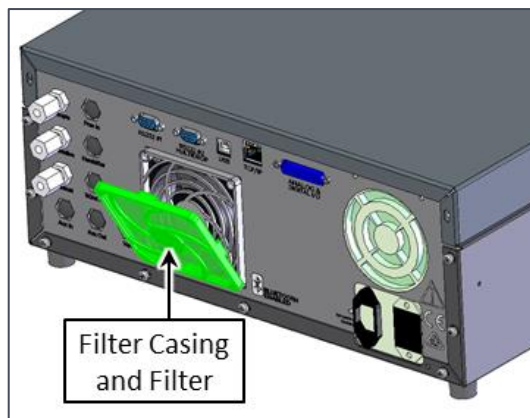

Figure 133 – Remove Filter Casing and Filter

2. Clean filter with water and dry it.

Note: Do not install the filter until completely dry, a wet filter can damage the instrument.

3. Reinstall filter and filter casing.

6.4.3 DFU Replacement

1. Turn OFF the instrument and unplug the power cord from mains power outlet.
2. Refer to Figure 134. Remove the Kynar nut from the end of the DFU by turning it anti-clockwise.

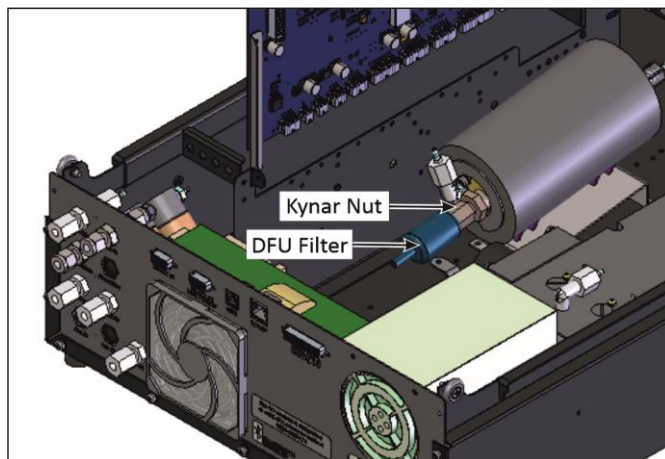

Figure 134 – Remove Kynar Nut

3. Replace the DFU and ensure that the flow is in the correct direction (arrow should point towards the Kynar nut).
4. Tighten the Kynar nut clockwise.

6.4.4 Leak Check

Equipment Required

- Vacuum Source (Pump)
- Leak Test Jig (PN: H050069)
- Kynar 1/4" Blocker Nuts
- 5/8" Spanner
- 9/16" Spanner

Note: Ensure that the instrument has been running for at least one hour before this procedure is performed.

Procedure

1. Turn OFF the vacuum source and allow the instrument to return to ambient pressure.
2. Disconnect any external tubing connected to the rear of the instrument.

-
3. Connect the leak check jig to the Exhaust Port of the instrument.

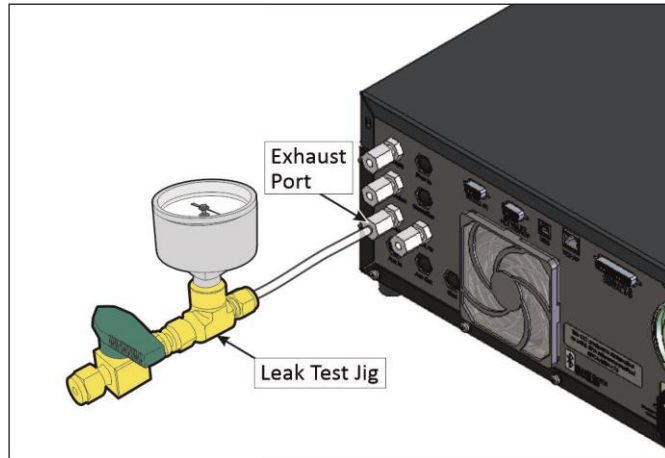

Figure 135 – Leak Test Jig on Exhaust Port

4. Connect a vacuum source to the shut off valve ensuring the shut off valve is in the open position.

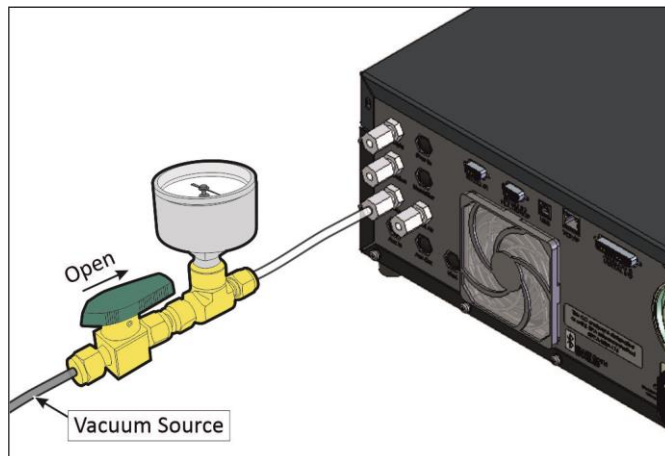

Figure 136 – Connect Vacuum Source

5. Block the instrument's **Sample Ports** with Kynar 1/4" blocker nut.

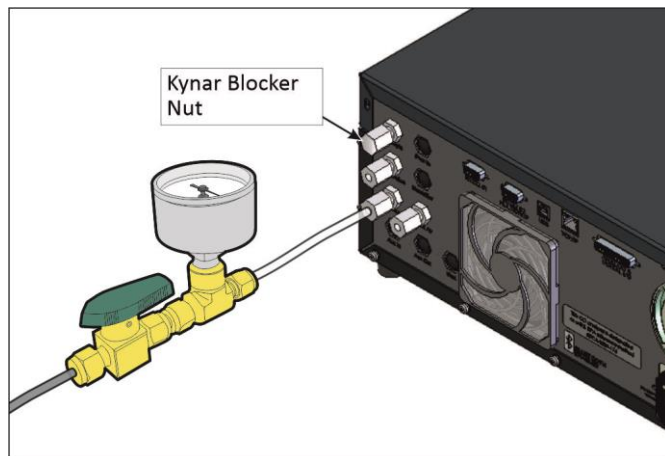

Figure 137 – Kynar Blocker Nut

6. Open - **Main Menu** → **Service Menu** → **Diagnostics Menu** → **Valve Menu**.
7. Disable - **Valve Sequencing** → **Disabled**.
8. Close - **Sample/Cal** → **Off**.
9. Close - **Internal Zero/Cal** → **Off**.
10. Close - **Pressurized Zero (OPT)** → **Off**.
11. Close - **Pressurized Span (OPT)** → **Off**.
12. Allow the instrument time to evacuate the pneumatic system (the time required will depend on the vacuum source used).
13. Close the shut off valve and record the vacuum indicated on the leak test jig. Wait for 3 minutes and observe the gauge on the leak test jig. It should not drop more than 5 kpa (37.5 torr). If it has, a leak is present within the sample cycle of the instrument.
14. If the instrument did not leak, skip to step 17.
15. Inspect the instrument's plumbing looking for obvious damage. Check the condition of fittings, sample filter holder plus the O-rings.
16. When the location of the leak has been determined, repair and re-run the leak check procedure.
17. Slowly release the vacuum by gradually loosening the Kynar 1/4" blocker nut on the **Sample Port**, until the instrument has returned to ambient pressure.
18. Block the instrument's **Background Air Ports** with Kynar 1/4" blocker nut.
19. Open - **Sample/Cal** → **On**.
20. Open the shut off valve.
21. Allow the instrument time to evacuate the pneumatic system (the time required will depend on the vacuum source used).
22. Close the shut off valve and record the vacuum indicated on the leak test jig. Wait for 3 minutes and observe the gauge on the leak test jig. It should not drop more than 5 kpa. If it has, a leak is present within the zero cycle of the instrument.
23. If the instrument did not leak, skip to step 26.
24. Inspect the instrument's plumbing looking for obvious damage. Check the condition of fittings and O-rings from the calibration valve up to the background air port.
25. When the location of the leak has been determined, repair and re-run the leak check procedure.
26. Slowly release the vacuum by gradually loosening the Kynar 1/4" blocker nut on the **Background Air Port**, until the instrument has returned to ambient pressure.
27. Block the instrument's **Calibration Ports** with Kynar 1/4" blocker nut.
28. Open - **Internal Zero/Cal** → **On**.
29. Open the shut off valve.
30. Allow the instrument time to evacuate the pneumatic system (the time required will depend on the vacuum source used).
31. Close the shut off valve and record the vacuum indicated on the leak test jig. Wait for 3 minutes and observe the gauge on the leak test jig. It should not drop more than 5 kpa. If it has, a leak is present within the span calibration cycle of the instrument.

-
32. If the instrument did not leak, skip to step 37.
 33. Inspect the instrument's plumbing looking for obvious damage. Check the condition of fittings and O-rings from the calibration valve manifold up to the **Calibration** port.
 34. When the location of the leak has been determined, repair and re-run the leak check procedure.
 35. Slowly release the vacuum by gradually loosening the Kynar 1/4" blocker nut on the **Calibration Port**, until the instrument has returned to ambient pressure.
 36. Open - **Main Menu** → **Service Menu** → **Diagnostics Menu** → **Valve Menu**.
 37. Enable - **Valve Sequencing** → **Enabled**.
 38. Inspect the tubing again ensuring the tubing is cleanly connected to the fittings.
 39. Remove the leak check jig and return the instrument to normal operation.

6.4.4.1 Leak Check (Internal pump option)

Equipment Required

- Barometer
- Kynar 1/4" Blocker Nuts
- 5/8" Spanner
- 9/16" Spanner
- 7/16" Spanner

Procedure

Note: Ensure that the instrument has been running for at least one hour before this procedure is performed.

1. Disconnect all external tubing connected to the rear ports of the instrument.
2. Open - **Main Menu** → **Service Menu** → **Diagnostics Menu** → **Internal Pump Menu**.
3. Select - **Pump Control** → **Manual** - Accept.
4. Edit - **Coarse** - (set to 240) - Accept.
5. Edit - **Fine** - (set to 255) - Accept.
6. Open - **Main Menu** → **Service Menu** → **Diagnostics Menu** → **Valve Menu**.
7. Disable - **Valve Sequencing** → **Disabled**.
8. Close - **Sample/Cal** → **Off**.
9. Close - **Internal Zero/Cal** → **Off**.
10. Close - **Pressurized Zero (OPT)** → **Off**.
11. Close - **Pressurized Span (OPT)** → **Off**.
12. Connect the barometer to **Sample Port**.
13. Allow the internal pump time to evacuate the pneumatic system (the time required will depend on the condition of the pump 1 - 2 minutes).
14. Turn the manual stop valve 90° (Close).
15. Open - **Main Menu** → **Service Menu** → **Diagnostics Menu** → **Internal Pump Menu**.

16. Toggle OFF - **Internal Pump** → **Off**.
17. Note the value on the barometer. Wait for 3 minutes, the value should not drop more than 5 kpa (37.5 torr). If the leak check passed skip to step 20.
18. Inspect the instrument's plumbing looking for obvious damage. Check the condition of fittings, sample filter holder plus the O-rings.
19. If the leak is still present divide up the pneumatic system into discrete sections to locate the leak (refer to Section 9.5). When the location of the leak has been determined repair and then rerun the leak check procedure.
20. Slowly remove the barometer from the **Sample Port**, allowing the instrument to return to ambient pressure.
21. Turn the manual stop valve 90° (Open).
22. Toggle ON - **Internal Pump** → **On**.
23. Open - **Sample/Cal** → **On**.
24. Connect the barometer to **Background Air** port.
25. Allow the internal pump to time to evacuate the pneumatic system (the time required will depend on the condition of the pump 1 - 2 minutes).
26. Turn the manual stop valve 90° (Close).
27. Open - **Main Menu** → **Service Menu** → **Diagnostics Menu** → **Internal Pump Menu**.
28. Toggle OFF - **Internal Pump** → **Off**.
29. Note the value on the barometer. Wait for 3 minutes, the value should not drop more than 5 kpa (37.5 torr). If the leak check passed skip to step 32.
30. Inspect the instrument's plumbing looking for obvious damage. Check the condition of fittings and O-rings from the calibration valve up to the **Background Air** port.
31. When the location of the leak has been determined, repair and re-run the leak check procedure.
32. Slowly remove the barometer from the **Background Air Port**, allowing the instrument to return to ambient pressure.
33. Turn the manual stop valve 90° (Open).
34. Toggle ON - **Internal Pump** → **On**.
35. Open - **Internal Zero/Cal** → **On**.
36. Connect the barometer to **Calibration** port.
37. Turn the manual stop valve 90° (Close).
38. Open - **Main Menu** → **Service Menu** → **Diagnostics Menu** → **Internal Pump Menu**.
39. Toggle OFF - **Internal Pump** → **Off**.
40. Note the value on the barometer. Wait for 3 minutes, the value should not drop more than 5 kpa (37.5 torr). If the leak check passed skip to step 43.
41. Inspect the instrument's plumbing looking for obvious damage. Check the condition of fittings and O-rings from the calibration valve manifold up to the **Calibration** port.
42. When the location of the leak has been determined, repair and re-run the leak check procedure.

-
43. Slowly remove the barometer from the **Calibration Port**, allowing the instrument to return to ambient pressure.
 44. Turn the manual stop valve 90° (Open).
 45. Open - **Main Menu → Service Menu → Diagnostics Menu → Valve Menu**.
 46. Enable - **Valve Sequencing → Enabled**.
 47. Open - **Main Menu → Service Menu → Diagnostics Menu → Internal Pump Menu**.
 48. Select - **Pump Control → Start** - Accept.

6.4.5 CO-CO₂ Converter Check

The internal CO-CO₂ converter provides a source of continuous CO free air for auto-zero and background functions. Failure of the converter can result in drift, poor sensitivity near zero and continuous electronic zero adjusts.

Note: Ensure that the instrument has been running for at least one hour before this procedure is performed.

Equipment Required

- Span gas source 40ppm CO
- 5/8" Spanner

Procedure

1. Open - **Main Menu → Calibration Menu**.
2. Select - **Cal. Type → Manual** - Accept.
3. Select - **Zero Source → Internal** - Accept.
4. Select - **Cal. Mode → Zero** - Accept.
5. Allow the instrument to sample **Zero** air from the CO-CO₂ for approximately 5 minutes.
6. Record the instrument response as the "Initial" value.

Note: This value should be 0.00 ± 0.1 ppm. If it is not, a background should be initiated by initiating the background field within the calibration menu. The background will take approximately 5 minutes to complete.

7. Connect 40 ppm CO span source to the **Background Air Port** ensuring the inlet pressure is maintained at ambient (vented).
8. Allow the instrument to sample the span source for 5 minutes.
9. Record the instrument response as the "Challenge" value.
10. Disconnect the span source.
11. Open - **Main Menu → Calibration Menu**.
12. Select - **Cal. Type → Manual** - Accept.
13. Select - **Zero Source → External** - Accept.
14. Select - **Cal. Mode → Measure** - Accept.

15. Compare the initial value and the challenge value. They should agree within ± 2 ppm. If not the CO₂ converter should be replaced.

6.4.6 Sintered Filter/Orifice Replacement

Equipment Required

- Orifice/filter removal tool (PN: H010046)
- 9/16" Spanner

Procedure

1. Remove the vacuum source from the **Exhaust Port**.
2. Refer to Figure 138. Unscrew the Kynar nut from the fitting (anti-clockwise).

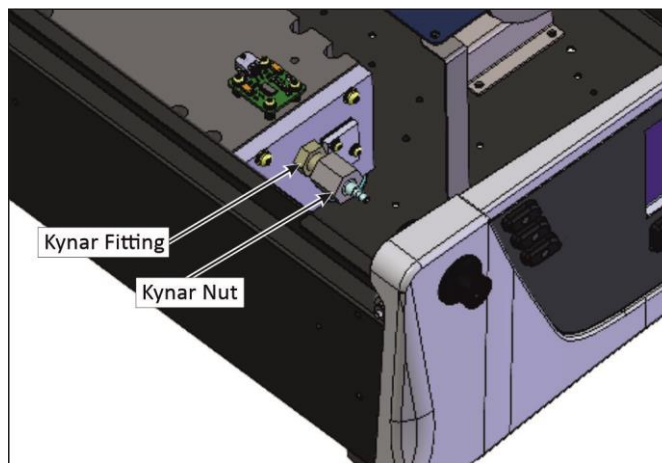

Figure 138 – Kynar Fitting Containing Orifice and Sintered Filter

3. Remove the Kynar fitting from the measurement cell (anticlockwise).
4. Remove the spring from fitting to gain access to the orifice.
5. Remove the orifice by screwing in the orifice removal tool (finer thread end) clockwise, then gently pull the orifice out of the fitting.
6. Remove the remaining O-ring and sintered filter.

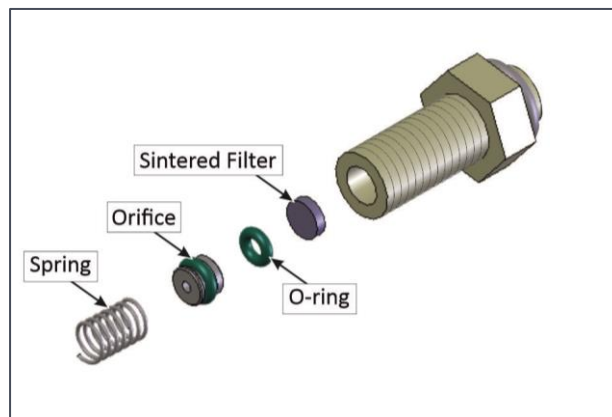

Figure 139 – Remove Orifice and Sintered Filter

-
7. Replace the sintered filter and O-ring. If you were getting the incorrect flow check the orifice isolated from the instrument. If flow of the isolated orifice is still bad clean or replace orifice. Ideally the orifice should be cleaned in a sonic bath with lab detergent and water.

Note: Replace the O-ring on the orifice if reusing.

8. Ensure the sintered filter, O-ring, orifice and spring go back in the fitting in the correct order.
9. Screw the fitting back into the measurement cell.
10. Replace the Kynar nut.
11. Perform a leak check (refer to Section 6.4.4).
12. Reconnect the vacuum source to the **Exhaust Port**.

6.4.7 Trim Pot Tuning Procedure

The following must be performed to ensure the Serinus 30 receives an optimal signal after the cell has been aligned. If this procedure is not performed, the Serinus 30 is likely to produce unstable results. If the **Input Pot** reads less than 180 (refer to Section 3.4.15), this is an indication that this procedure needs to be performed.

Equipment Required

- Pot Adjustment tool

Procedure

1. Open - **Main Menu** → **Service Menu** → **Diagnostics Menu**.
2. Disable - **Control Loop** → **Disabled**.
3. Open - **Digital Pots Menu**.
4. Edit - **Input Pot** - (Adjust to 200) - Accept.
5. Refer to Figure 140. Adjust the trim pot on the detector assembly such that the **Ref. Voltage** reads $4.05\text{ V} \pm 0.05\text{ V}$.

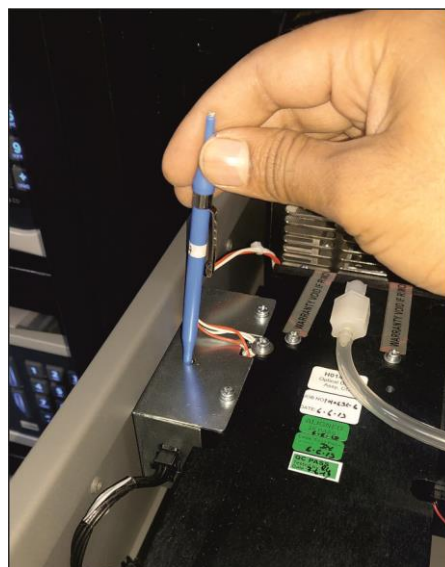

Figure 140 – Adjust Trim Pot

6. Back - **Diagnostics Menu**.
7. Enable - **Control Loop** → **Enabled**.
8. Run a manual background.

**CAUTION**

Not using the correct tool can cause the damage to detector PCA.

6.4.8 Clean Pneumatics

The **Calibration Valve Manifold** will require disassembling and cleaning. Ideally the valves and the manifold should be cleaned in a sonic bath with lab detergent and distilled water. Once clean rinse with distilled water and dry with clean dry oil free air before reassembling. A leak test should be performed once the instrument is ready for operation (refer to Section 6.4.4).

Note: If the tubing shows signs of significant contamination, it should be replaced with new tubing. Do not clean the **CO-CO₂ converter** or the mirrors found within the **Measurement Cell**.

6.4.9 Pressure Sensor Check

Pressure checks are needed to ensure that the pressure sensor is accurately measuring pressure inside the instrument.

During normal operation ensure that the pressure and flow menu indicate the following parameters. Ambient should display the current ambient pressure at site. Cell should indicate current cell pressure depending on the pump condition and location. The cell pressure is normally about 20 torr below ambient.

Equipment Required

- Barometer
- Digital Multimeter (DMM)

Procedure

1. Open - **Main Menu** → **Analyser State Menu** → **Pressure & Flow Menu**.
2. Turn OFF the vacuum pump and allow the instrument to return to ambient.
3. Disconnect the exhaust and sample port connections.
4. After 2 - 5 minutes observe the pressure readings: ambient and cell. Ensure that they are reading the same ± 3 torr (± 0.4 kPa).
5. If the readings are outside this level, perform a pressure calibration (refer to Section 5.2).

If the pressure calibration fails, the instrument may have a hardware fault. The cell pressure PCA has test points. To determine the condition of the sensor measure and the voltage on the test points, refer to Figure 141. The voltage measured across the test points is proportional to the pressure measured by the sensor. If the sensor is exposed to ambient pressure at sea level, the voltage will be around 4 volts but if the sensor is under vacuum, the voltage will be low (e.g. 0.5 volts). If the test point measures zero or negative voltage, the assembly is most likely faulty and will need to be replaced.

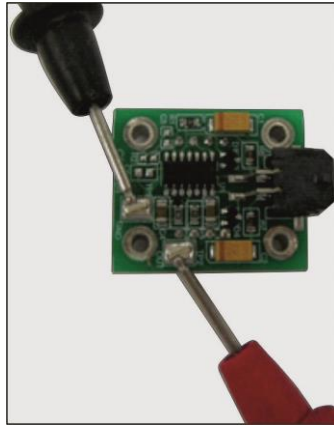

Figure 141 – Test Point Location

6.5 Bootloader

The Serinus Bootloader is the initial set of operations that the instruments' microprocessor performs when first powered up (similar to the BIOS found in a personal computer). This occurs every time the instrument is powered up or during instrument resets. Once the instrument boots up, it will automatically load the instruments' firmware. A service technician may need to enter the Bootloader to perform advanced microprocessor functions as described below.

To enter the Bootloader turn OFF the power to the instrument. Press and hold the plus key while turning the power ON. Hold the Plus key until the following screen appears.

Ecotech Analyser / Calibrator V3.0 Bootloader Press '1' to enter Bootloader

If the instrument displays the normal start up screen, the power will need to be toggled and another attempt will need to be made to enter the Bootloader. Once successful, press 1 to enter the **Bootloader Menu**.

6.5.1 Display Help Screen

Once in the Bootloader screen it is possible to redisplay the help screen by pressing 1 on the keypad.

6.5.2 Communications Port Test

This test is very useful for fault finding communication issues. It allows a communication test to be carried out independent to any user settings or firmware revisions.

This command forces the following communication ports to output a string of characters: Serial Port RS232 #1, USB rear and Ethernet Port. The default baud rate is 38400 for the RS232 Serial Port. To initiate the test press the number 2 key from the Bootloader screen.

6.5.3 Updating Firmware

It is important for optimal performance of the instrument that the latest firmware is loaded. The latest firmware can be obtained by visiting Ecotech's website:

<http://www.ecotech.com/downloads/firmware>

Or by emailing Ecotech at service@ecotech.com or support@ecotech.com

To update the firmware from a USB memory stick, use the following procedure:

USB Memory Stick Update

1. Turn the instrument OFF.
2. Place the USB memory stick with the new firmware (ensure that firmware is placed in a folder called FIRMWARE) in the front panel USB Port.
3. Enter the Bootloader (refer to Section 6.5).
4. Select option 3 (upgrade from USB memory stick), press 3 on the keypad.
5. Wait until the upgrade has completed.

6.5.4 Erase All Settings

This command is only required if the instruments firmware has become unstable due to corrupted settings. To execute this command enter the **Bootloader Menu** (refer to Section 6.5) and press 4 on the keypad.

6.5.5 Start Analyser

The start analyser command will simply initiate a firmware load by pressing 9 on the keypad from the **Bootloader Menu**. It is generally used after a firmware upgrade.

This page is intentionally blank.

7. Troubleshooting

Before troubleshooting any specific issues, Ecotech recommends ensuring the instrument has successfully completed its warm-up routine and all issues listed in the instrument status menu are resolved (refer to Section 3.4.4).

Table 9 – Troubleshoot List

Error Message/Problem	Cause	Solution
Flow fault	Multiple possibilities	Refer to Section 7.1.
	Pump failed	Replace the internal or external pump.
	Blocked filter or orifice - only installed in external pump optioned instrument.	Replace sintered filter and orifice (refer to Section 6.4.6).
	Pressurised measurement cell	Ensure sample and zero inlets are maintained at ambient pressure (vented to atmosphere).
	Pressure sensors	Perform a pressure calibration (refer to Section 5.2). Or replace sensor if required.
Noisy/unstable readings	Multiple possibilities	Refer to Section 7.2.
	Calibration system error	Ensure calibration system is functioning correctly and is leak free. Ensure sufficient gas is available for instrument and an adequate vent is available for excess gas.
	Leaks	A leak in the instrument or calibration system dilutes the sample stream and causes low span readings and noise.
	Temperature unstable	A failed temperature control allows the instrument to drift with ambient temperature. Verify that both the cell and mirror temperatures are $50\text{ }^{\circ}\text{C} \pm 3\text{ }^{\circ}\text{C}$. Chassis lid not in place causing instrument to drift with ambient temperature. Chassis temperature drifting with ambient temperature fluctuations. Stabilise ambient temperature and remove instrument from direct ambient heating or cooling.
	Hardware fault	Measurement cell internal hardware loose. Mirrors have detached or degraded.

	Commissioning error	Measurement cell travel screws are still fastened (refer to Section 2.3.4).
	Gain too high	Leak check, repair any leaks. (refer to Section 6.4.4) Measurement cell internal hardware loose – return to nearest service centre. Mirrors have detached or degraded – return to nearest service centre. Correlation wheel has leaked replace correlation wheel.
Cell temperature failure	Faulty heater or temperature sensor	Refer to Section 7.3.
Mirror temperature failure	Faulty heater or temperature sensor	Refer to Section 7.4.
Instrument resetting	Multiple possibilities	Check that the instrument is not overheating. Possibly a faulty power supply. Corrupted firmware. Perform an 'erase all settings' in the Bootloader Menu and reload or upgrade firmware (refer to Section 6.5.4).
12 Voltage supply failure	Power supply has failed	Replace power supply.
No display	Contrast adjustment required	Adjust the display contrast by pressing either of the two scrolling buttons on the front panel: Press Up scrolling button (▲) for darker contrast. Press Down scrolling button (▼) for lighter contrast.
	DC power	Verify that the power supply is providing ± 12 V, +5 V DC. TP40, TP23 and TP41.
	Display	Check the interface cable between the display and the microprocessor board.
	Bad display or main controller PCA	Replace the front panel display. Replace the main controller PCA. Bad cables are unlikely, but if suspect it; perform a pin-for-pin continuity test using an ohmmeter.
	AC power	Verify that the mains power cable is connected and the rear fan is operating.
Sample pressure too high or low	Loss of pressure calibration	Perform a pressure calibration (refer to Section 5.2).

		<p>Ensure particulate filter has been recently changed.</p> <p>Ensure tubing is not kinked or blocked.</p> <p>Ensure vacuum pump is correctly installed and operating.</p>
Sample flow not at 1 slpm	Multiple possibilities	<p>Check/replace sample filter.</p> <p>Check pump.</p> <p>Check valves.</p> <p>Check/replace sintered filter.</p> <p>Re-calibrate pressure sensors.</p>
Unstable flow or pressure readings	Faulty pressure sensors	<p>Check pressure calibration.</p> <p>Check calibration valve block is functioning and not blocked. If unable to diagnose problem, check the voltage across TP1 and TP2 of pressure sensor PCA. Ensure it is about 4 volts \pm 0.3 volts. If unable to diagnose problem, it may be a noisy A/D converter, replace main controller PCA.</p>
Low span	Leaks	<p>A leak in the instrument or calibration system dilutes the sample stream and causes low span readings and noise.</p> <p>Correlation wheel has leaked replace correlation wheel.</p>
	Span calibration out	Adjust the span using the calibration procedure (refer to Section 5.5).
No response to span gas	Leaks/blockages	Leak or blockages in tubes or valves. Perform leak check and flow check and repair any leaks/blockages.
	Faulty calibration source	Ensure calibration gas is plumbed correctly and is not contaminated or has no leaks and is a certified reference gas.
	Hardware fault	Faulty Measurement cell.
	Correlation wheel leaking	Replace correlation wheel.
Zero drift	Poor temperature control	Ensure instrument is operated in a temperature controlled environment with the lid on.
	Faulty zero air	Ensure zero air source is not overly polluted.
	Leak	Perform a leak test (refer to Section 6.4.4).
	CO-CO ₂ converter faulty	Replace CO-CO ₂ converter.

Negative zero	Indicates that the internal zero air converter is less efficient than the external zero air supplied	Perform a leak test (refer to Section 6.4.4). Check the internal zero air supply is equipped with a functioning CO-CO ₂ converter.
---------------	--	--

7.1 Flow Fault

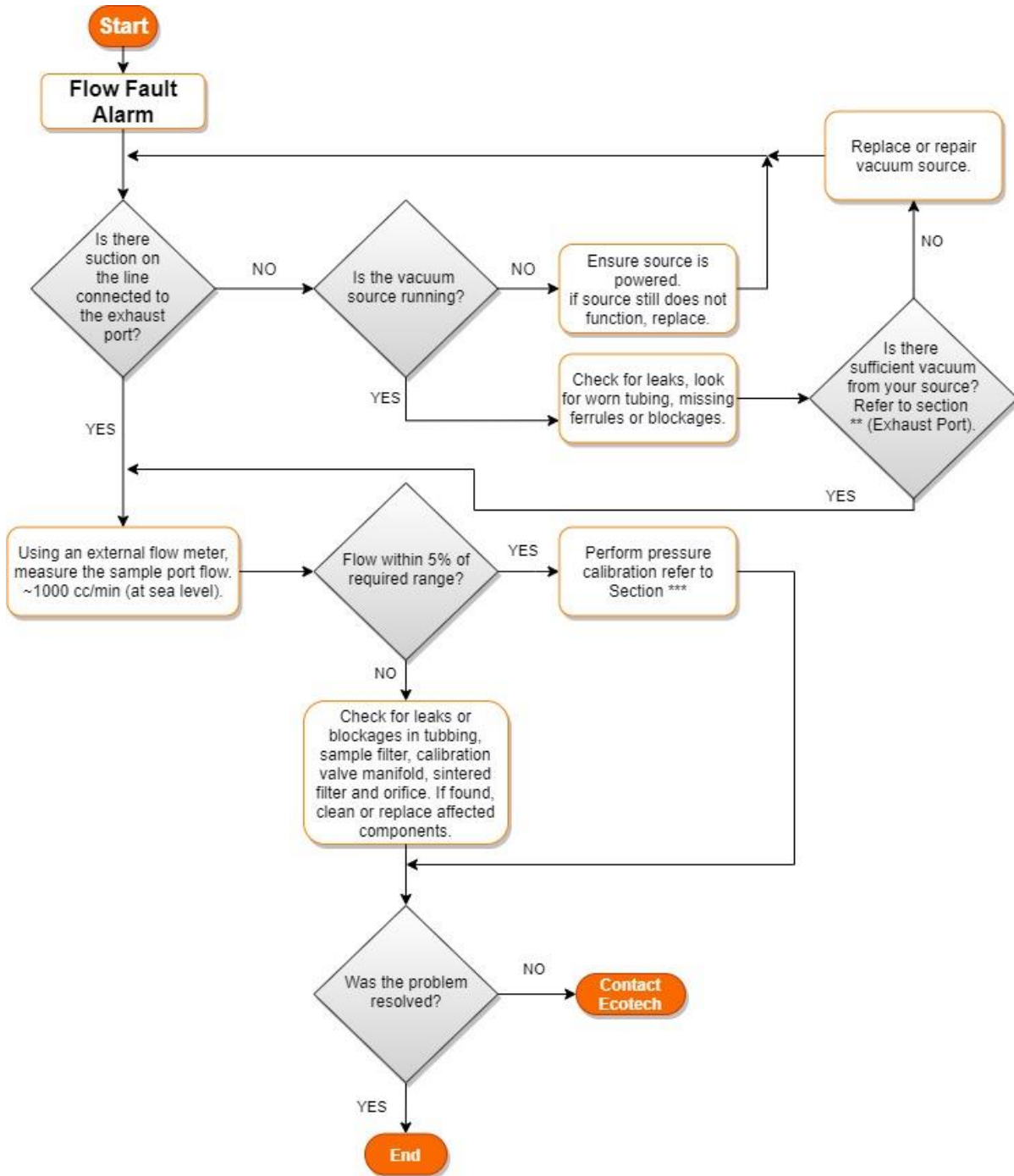

Figure 142 – Flow Fault Diagnostic Procedure

** Section 2.3.2

*** Section 5.2

7.2 Noisy/Unstable Readings

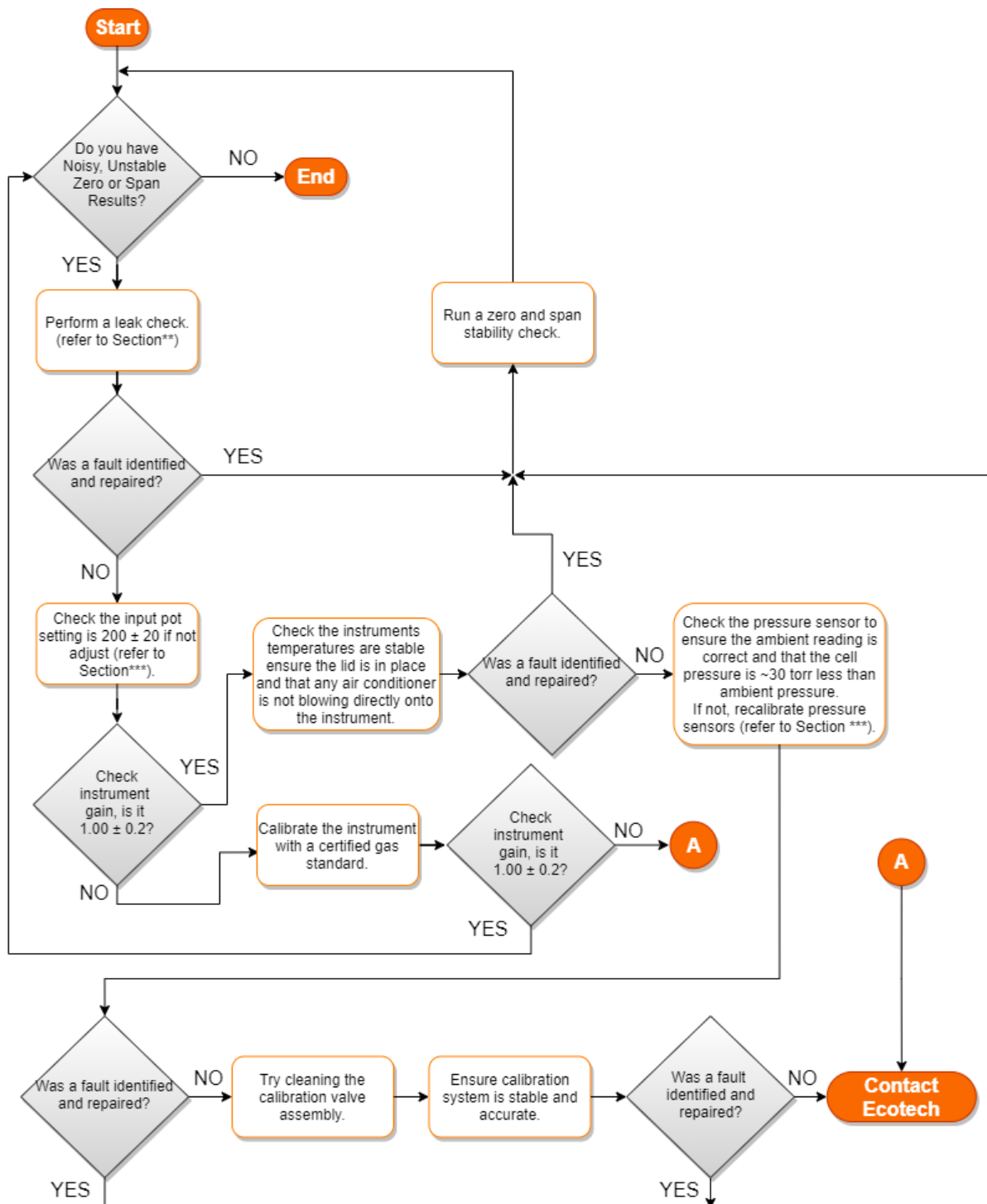

Figure 143 – Noisy Zero or Unstable Span Diagnostic Procedure

** Section 6.4.4

*** Section 6.4.7

**** Section 5.2

7.3 Cell Temperature Failure

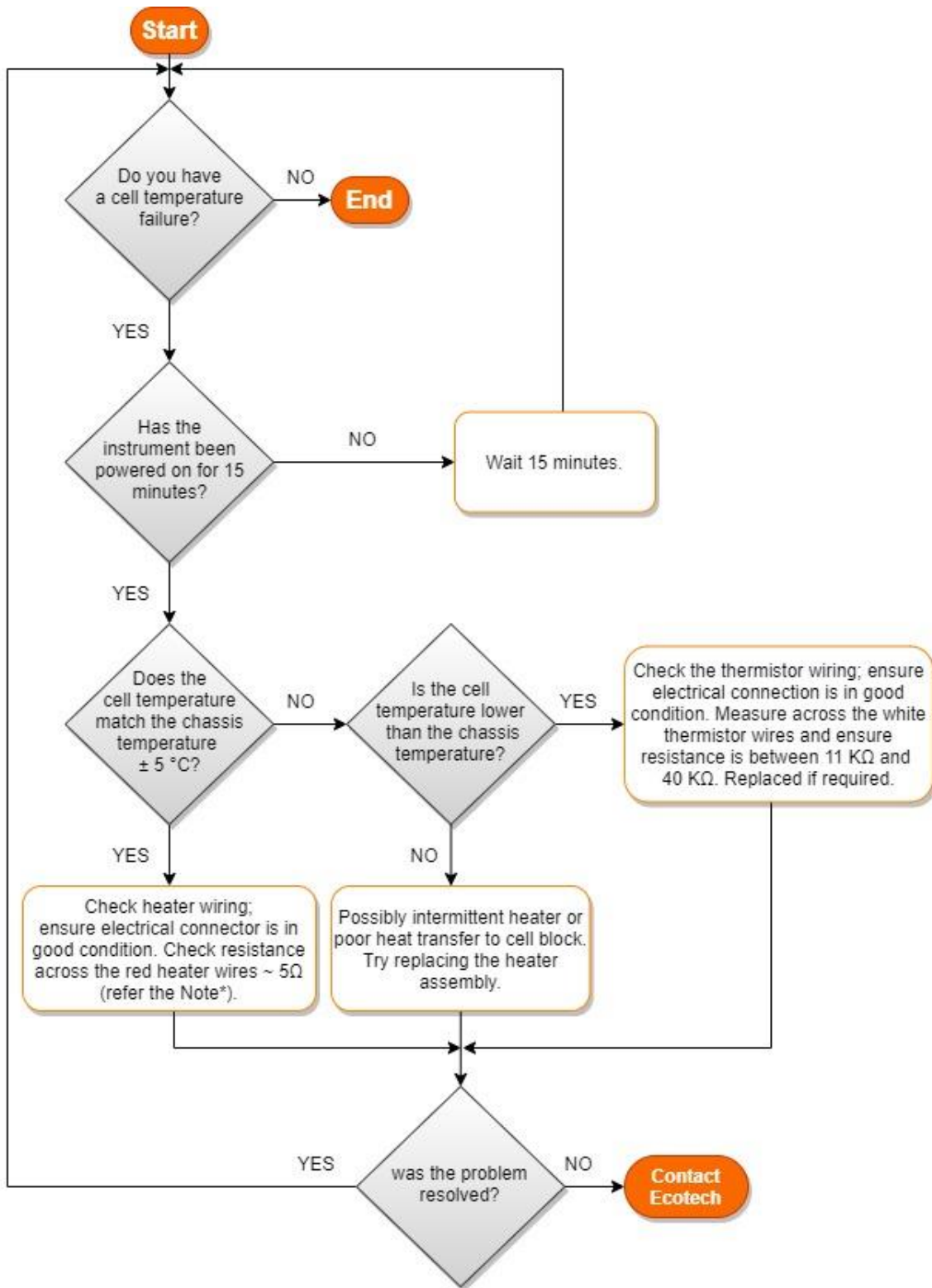

Figure 144 – Cell Temperature Failure Diagnostic Procedure

Note: Be careful using multimeter probes as they can damage the microfit connector.

7.4 Mirror Temperature Failure

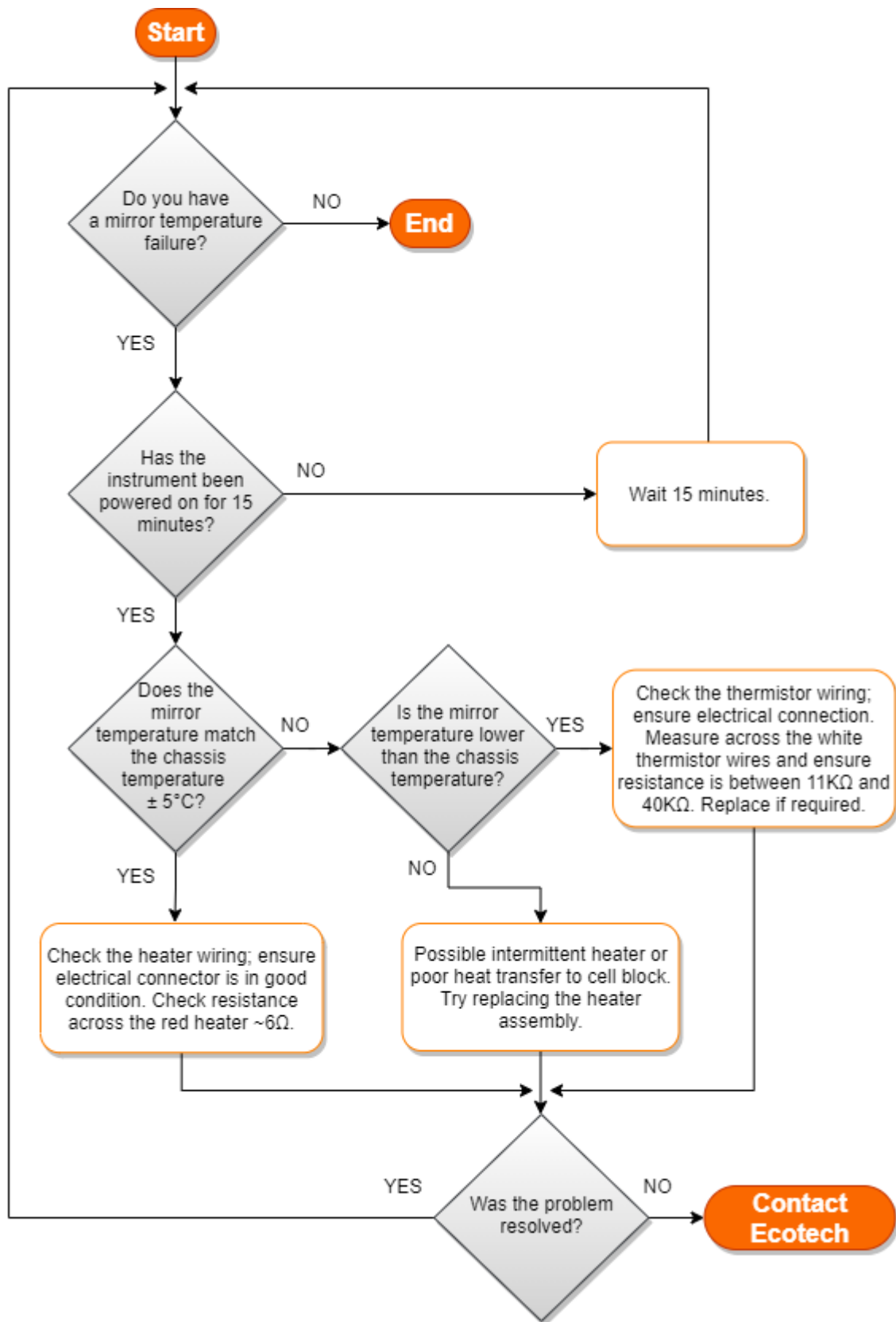

Figure 145 – Mirror Temperature Failure Diagnostic Procedure

7.5 USB Memory Stick Failure

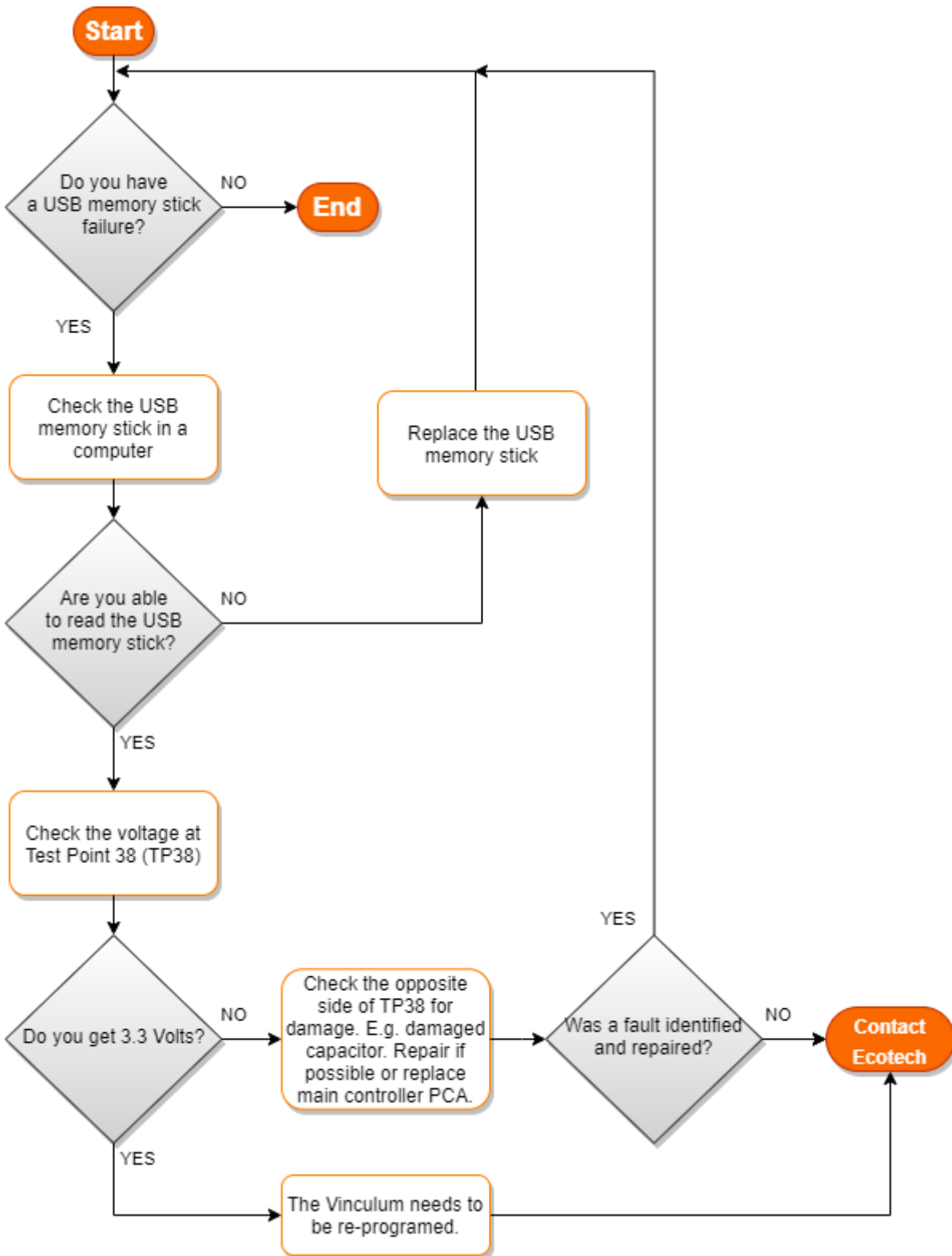

Figure 146 – USB Memory Stick Failure

7.6 Ecotech Service Support Files

Regular backup of the settings, parameters and data on the instruments USB memory stick is recommended.

In the event of a fault that requires Ecotech technical support, make copies of the following files and email to support@ecotech.com.

Equipment Required

- PC/Laptop

Procedure

State the ID number, model, board revision and firmware version of the instrument with a brief description of the problem. Take a copy of the current configuration if possible and a save of the parameters.

1. Open - **Main Menu** → **Analyser State Menu**.
2. **Model** - (take note).
3. **Ecotech ID** - (take note).
4. **Board Revision** - (take note).
5. **Firmware Ver.** - (take note).
6. Open - **Main Menu** → **Service Menu**.
7. Save - **Save Configuration** - (CONFIG**.TXT) - Accept.

Note: CONFIG99.TXT is the “Factory Backup” file, this is the configuration of the instrument as it left the factory. It is recommended that this file is kept unchanged but can be used as a reference backup point.

** Can be any number from 0 - 98.

8. Save - **Save Parameter List** - (PARAM**.TXT) - Accept.
9. Eject - **Safely Remove USB Stick** - (Follow instructions).

Note: PARAM99.TXT is the “Factory Backup” file, this is a snap shot of the parameters while it was under test in the factory just prior to release. It is recommended that this file is kept unchanged but can be viewed for reference.

** Can be any number from 0 - 98.

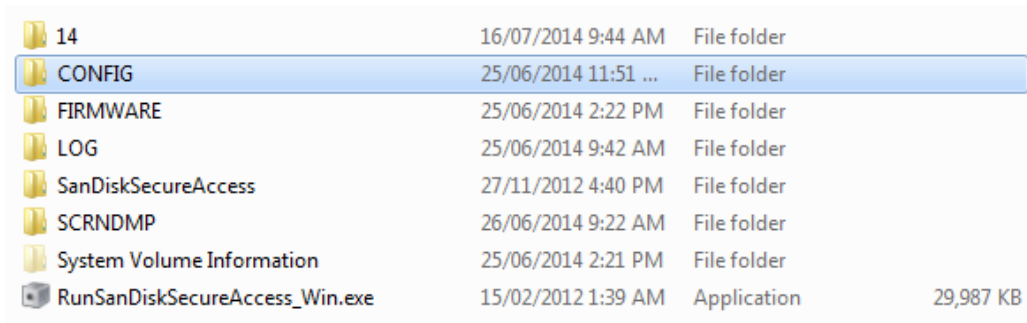

14	16/07/2014 9:44 AM	File folder	
CONFIG	25/06/2014 11:51 ...	File folder	
FIRMWARE	25/06/2014 2:22 PM	File folder	
LOG	25/06/2014 9:42 AM	File folder	
SanDiskSecureAccess	27/11/2012 4:40 PM	File folder	
SCRNDMP	26/06/2014 9:22 AM	File folder	
System Volume Information	25/06/2014 2:21 PM	File folder	
RunSanDiskSecureAccess_Win.exe	15/02/2012 1:39 AM	Application	29,987 KB

Figure 147 – USB Memory Stick File Structure

10. Insert the USB memory stick into a PC/Laptop computer and access the files.
11. Best practice is to email all the on the USB memory stick but if it's too large just send:
12. The CONFIG**.TXT and PARAM**.TXT files that are saved in the CONFIG folder.
13. The LOG files (Event Log text files) and data files (14=Year, Sub folder=month).
14. Safely Eject the USB from the PC/Laptop and return to the instrument.

This page is intentionally blank.

8. Optional Extras

This section contains information on optional kits and installed options.

Dual Sample Filter	Refer to Section 8.1.
Network Port	Refer to Section 8.2.
Rack Mount Kit	Refer to Section 8.3.
Internal Pump	Refer to Section 8.4.
Metric Fittings Kit	Refer to Section 8.5.
High Pressure Zero/Span Valves	Refer to Section 8.6.
Trace Level Instrument	Refer to Section 8.7.
External CO ₂ sensor	Refer to Section 8.8.

8.1 Dual Sample Filter (PN: E020100)

The dual filter is designed with two sample filters plumbed in parallel with a split line. This formation allows sample flow not to be affected, yet reduces the loading on each filter and therefore, the frequency with which they will need to be changed.

The dual filter option is shown in the pneumatic diagram (dashed line) and requires no operational changes to the instrument (refer to Section 9.5).

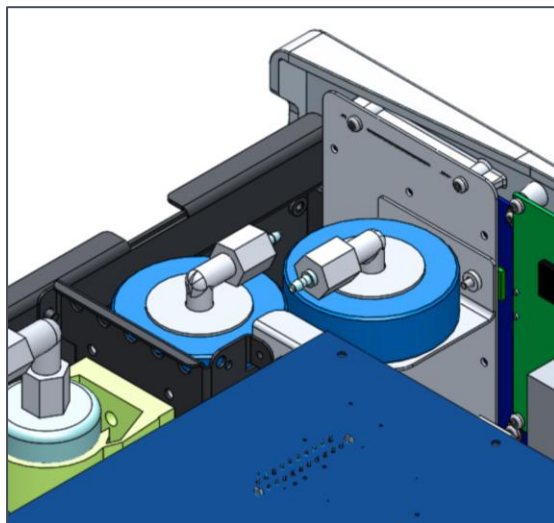

Figure 148 – Dual Filter Option Installed

8.2 Network Port (PN: E020101)

The network port option allows the user to setup and connect to a range of TCP/IP network options. If the user has this option installed they need to make sure it is enabled in the **Hardware Menu** before the feature can be used.

- Refer to Section 3.4.29, for details on the network menu.
- Refer to Section 4.3, for details on network setup.

8.2.1 Hardware Setup

This procedure will need to be followed after a factory reset.

Procedure

1. Press - (the green instrument status light button), to return to the home screen.
2. Press - (-99+) on the keypad to open the **Advanced Menu**.
3. Open - **Advanced Menu** → **Hardware Menu**.
4. Enable - **Network Port** → **Enabled**.

8.3 Rack Mount Kit (PN: E020116)

The rack mount kit is necessary for installing the Serinus into a 19" rack (the Serinus is 4RU in height).

Table 10 – Included Parts (Rack Mount Kit)

Description	Quantity	Part Number
Rack Slide Set	1	H010112
Rack Mount Adaptors	4	H010133
Rack Mount Ears	2	H010134
Spacers	4	HAR-8700
M6 x 20 Button Head Screws	8	
M6 Washers	16	
M6 Nyloc Nuts	8	
M4 x 10 Button Head Screws	18	
M4 Washers	8	
M4 Nyloc Nuts	8	
M6 Cage Nuts	8	

Installing the Instrument

1. Remove the rubber feet from the instrument (if attached).

2. Refer to Figure 149. Separate the slide rail assembly by pressing the black plastic clips in the slide rails to remove the inner section of the rail.

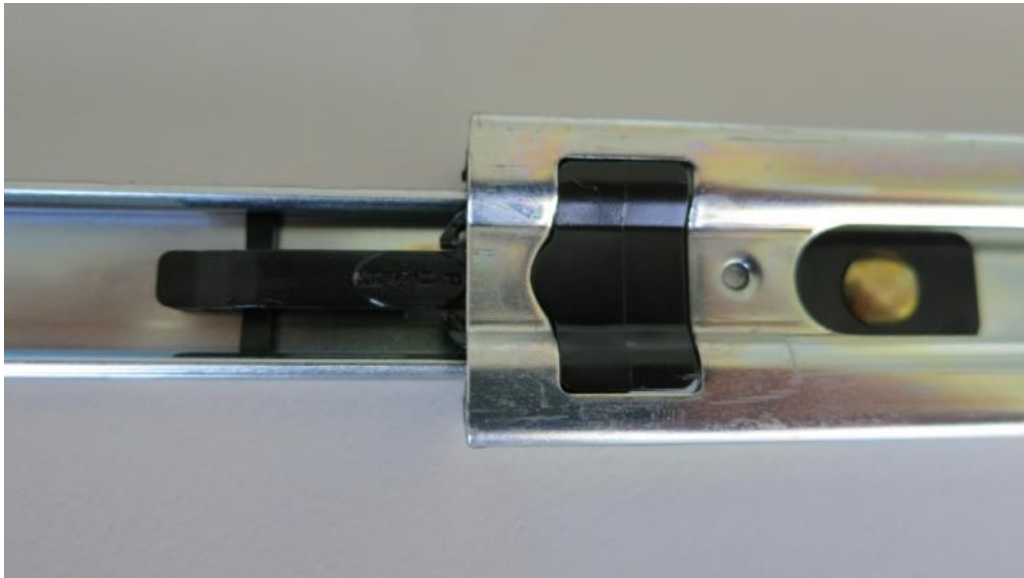

Figure 149 – Separate Rack Slides

3. Refer to Figure 150. Attach the inner slide rails to each side of the instrument using M4 x 10 button screws; three on each side.



Figure 150 – Assemble Inner Slide on Chassis

-
4. Refer to Figure 151. Install rack mount ears on the front of the instrument using two M4 x 10 screws on each side.



Figure 151 – Rack Mount Ears Fitted to Instrument

5. Refer to Figure 152. Attach the rack mount adaptors to the ends of the outer slide rails using M4 x 10 button screws, washers and locknuts. Do not fully tighten at this stage as minor adjustments will be required to suit the length of the rack.



Figure 152 – Attach Rack Mount Adaptors to Outer Slides

6. Test fit the rack slide into the rack to determine the spacing of the rack mount adaptors.

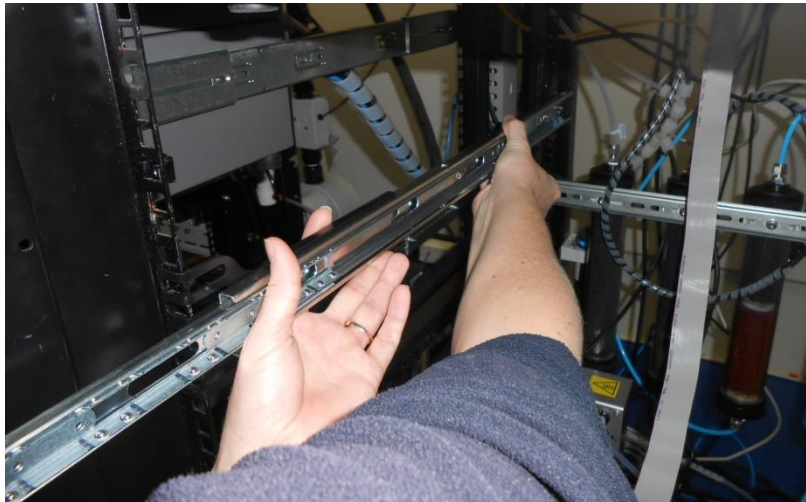

Figure 153 – Test Fit the Rack Slide Assembly into the Rack

7. Refer to Figure 154. Install the two assembled outer slide rails onto the left and right side of the rack securely with M6 bolts; washer and locknuts/cage nuts.

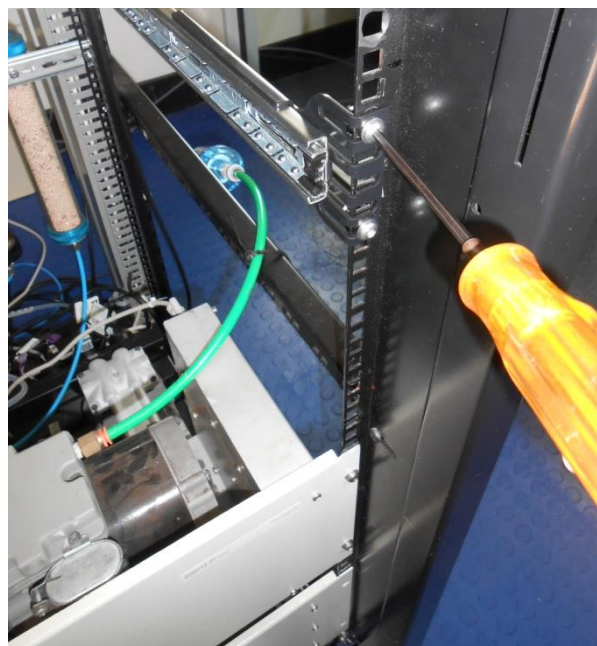

Figure 154 – Attach Slides to Front of Rack

8. Now carefully insert the instrument into the rack by fitting the instrument slides into the mounted rails. Ensuring that the rack slide locks engage on each side.



CAUTION

11. When installing this instrument ensure that appropriate lifting equipment and procedures are followed. It is recommended that two people lift the instrument into the rack due to the weight, unless proper lifting equipment is available.

Note: Ensure both sides of the inner slide are attached to the outer slides before pushing into the rack fully.

9. Push the instrument into the rack. Adjust and tighten the screws as required to achieve a smooth and secure slide.

To Remove the Instrument

1. To remove the instrument first pull instrument forward of rack giving access to the slides.
2. Find the rack slide lock labelled **Push** and push it in whilst sliding the instrument out of the rack, complete this for both sides while carefully removing instrument.

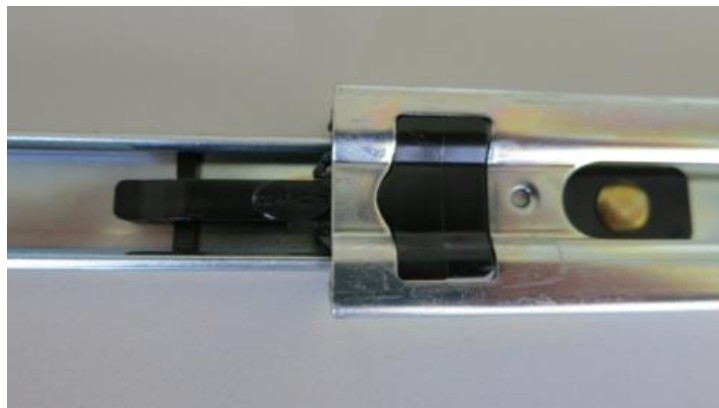

Figure 155 – Slide Clips

8.4 Internal Pump (PN: E020107)

8.4.1 Hardware Setup

This procedure should be followed after a factory reset.

Equipment Required

- NA

Procedure

1. Press - (the green instrument status light), to return to the home screen.
2. Press - (-99+) on the keypad to open the **Advanced Menu**.
3. Open - **Advanced Menu** → **Hardware Menu**.
4. Enable - **Internal Pump** → **Enabled**.

8.4.2 Internal Pump Additional Components

The Serinus 30 internal pump option includes the following additional components:

Table 11 – Internal Pump Additional Components

Component	Description	Part number
Internal Pump	Draw sample through the instrument	H010027
Flow Block	Includes sintered filter and differential pressure sensor to measure flow.	H010120
Heater and Thermistor	Mounted in flow block to measure and control temperature for accurate flow measurement.	Installed in flow block
Gasket	Used to thermally isolate the flow block assembly from the Serinus chassis.	H010119
Pressure Cable	Used to connect differential pressure PCA of the flow block to main controller PCA.	C020062-02
Heater Thermistor Cable	Used to connect heater thermistor assembly of the flow block to the main controller PCA.	C020083
Stop Valve	Valve used to isolate pump from the pneumatic circuit of the instrument.	H030170
Micro Wire Saddle	Used to cable management	H030121

8.4.3 Internal Pump Removed Components

The Serinus 30 has a number of components missing from the standard instrument due to the presence of the internal pump and flow block controlling flow within the instrument. The parts that have been removed when this option is installed are listed in the table below.

Table 12 – Internal Pump Removed Components

Component	Part number
Sintered filter	F010004
O-ring	O010012
Spring	H010040
O-ring	O010013
Orifice	H010043-13

8.4.4 Pressure Calibration Internal Pump Option

The internal pump requires a separate modified procedure to allow the internal pump to generate the necessary vacuum (refer to Section 5.2.3).

8.4.5 Flow Calibration

The flow calibration menu is only available when the internal pump option is installed (refer to Section 3.4.12).

The internal pump requires a separate flow calibration procedure. The flow calibration detailed in Section 5.8 must be performed after any pump service or pressure calibration.

8.4.6 Internal Pump Leak Check

The internal pump requires a separate modified procedure to leak check the system (refer to Section 6.4.4.1).

8.4.7 Pump Control

This section describes how to turn OFF and ON the internal pump for servicing and maintenance purposes.

Procedure

1. Open - Main Menu → Service Menu → Diagnostics Menu → Internal Pump Menu.
2. Select - **Pump Control** → **Manual**.
3. Toggle OFF - **Internal Pump** → OFF.

8.5 Metric Fittings Kit (PN: E020122)

The metric fittings kit allows the user to connect 6 mm tubing to the rear ports of the analyser. This can be very handy if it is hard to source 1/4" tubing from a local supplier.

8.6 High Pressure Zero/Span Valves

High pressure span calibration valve (factory installed (PN: E020108))

High pressure zero calibration valve (factory installed (PN: E020109))

For more information on how to setup and use the high pressure valves refer to Section 5.9.

Refer to Section 9.11 for the exploded assembly drawing.

Note: Before using a high pressure span or zero as a source for calibrating the instrument, check local regulatory requirements.

8.7 Trace Level Instrument (PN: E020127)

The trace option enables the instrument to detect levels carbon monoxide (CO) from 0 - 20,000 ppb with a lower detectable limit of 20 ppb. This allows the Serinus 30 Trace to sample in the most useful range for CO background measurement (25 - 500 ppb CO in air, levels that represent the range of global CO mixing ratios in the unpolluted atmosphere).

The Serinus 30 Trace has a number of extra passes in the measurement cell to increase the resolution, along with a thermally stabilised detector housing with a more sensitive IR detector operating at a lower temperature (-50 °C) to reduce thermal noise.

This option is also available without a dryer (PN: E020120).

8.7.1 Trace Specifications

The following tables list the changes to a standard instrument with the trace option installed.

Table 13 – Trace Parts Removed

Parts Removed	Quantity	Part Numbers
Measurement Cell	1	H014100

Table 14 – Trace Parts Added

Parts Added	Quantity	Part Number
Trace Measurement Cell	1	H014100-02
Dryer	1	H014180

8.7.2 Measurement

Range

0 - 20 ppm (autoranging)

Lower detectable limit: 20 ppb, with Kalman filter active

8.7.3 Precision/Accuracy

Noise at Zero

< 10 ppb

8.7.4 Calibration

Zero Drift

24 hours: < 50 ppb

Span Drift

24 hours: 1% of reading or 50 ppb whichever is greater

8.7.5 Trace setup

Sighting and System Setup

The sensitivity of the Serinus 30 trace requires special materials to be used for all measurement path lines. These materials must be inert to the pollutant being measured as shown below.

- Sample Column: The Sample Column should be made of glass to prevent reactions with air drawn into column.
- Sample Hood: The Sample Hood should be made of Teflon, ensuring that there is no sample retention.
- Lines: All sample transport tubing, including zero and calibration lines, must be made of virgin Teflon, PTFE or FEP.
- Regulator: A High purity, stainless steel dual stage regulator should be used.
- Stainless steel chromatography grade 1/8" gas lines should be used to connect span gas cylinder to gas dilution device.
- Calibration should be carried out by flooding the sample manifold with 10 - 20 L/min of calibration gas. This method ensures that all sample gas contact areas are exposed to the calibration gas.
- Zero calibrations should also involve flooding with zero gas at 10 - 20 L/min
- Sample gas residence time in the manifold should be less than 3.5 seconds.

Instrument

A standard Serinus 30 draws ambient air from within its localised area when performing a background while when sampling it draws the sample from a sample manifold. The difference between air sources (sample and background) may alter readings on a trace level instrument. Trace instruments can detect these slight differences so background and sample air must be drawn from an identical source. The trace instruments obtain background air from the same source as the sample air, helping standardise air samples and eliminating potential differences such as humidity.

- Connect 1/4" virgin PTFE FEP tubing between the sample manifold and the sample inlet on the instrument.
- Connect 1/4" virgin PTFE FEP tubing from the BGnd Air Port to the sample manifold. Or if no ports are available on the sample manifold add a tee connection with the tubing going to the sample inlet on the instrument.

8.7.6 Trace Operation

Please refer to Section 9.5 for a detailed pneumatic diagram.

Pneumatics

A standard Serinus 30 instrument uses calibration valves to supply sample, span and zero air to the inlet. The small error created from delivering gas through different lines is not measurable in standard instruments but can offset results in a trace level instrument. To eliminate this difference the zero and

span gas is flooded directly into the sample manifold (the manifold pump or fan is disabled and isolated with a valve) to a point where it fills the entire manifold and overflows preventing any ambient external air from entering. Thus the manifold inlet now becomes the calibration vent. The air within the manifold is then drawn through the instrument where measurements can be taken and compared to the concentration being delivered by the calibration system.

8.7.7 Trace Default Values

The Serinus 30 Trace default parameters vary from the Serinus 30 standard setup. The following is a list of differing parameters and their new default/expected values.

Table 15 – Trace Parameter Value Changes

Parameter	Default Value
Cooler Pot	255
Cooler Voltage	2.0 V

8.7.8 Trace Calibration Guidelines

To perform a multipoint calibration follow the procedure outlined in Section 5.7 for general setup, some aspects of calibration need more attention to detail. These following steps detail some of the changes in the calibration procedure that must be understood before performing any calibration.

Note: Before commencing a multipoint calibration, perform a manual background with diluted zero air flowing at 10 - 20 Lpm in the sample manifold.

- Span/Zero gas should be injected directly into the sample manifold with a volume that will flood the manifold preventing any external air from entering and influencing the Span/Zero gas.
- Losses may occur in sample manifold and tubing due to contaminants entering during normal measurement cycle. Flooding the sample manifold and tubing with zero air can help clean these contaminants out.
- The instrument must be powered up and in normal measurement calibration mode (ie all gas lines are attached and ready for use) for up to 48 hours before a calibration can be performed.

Note: A 48 hour preconditioning is necessary to warm-up materials and ensures that the instrument is working at its optimum when the calibration is performed. This preconditioning is particularly important for trace instrument calibrations due to the sensitive nature of the measurements.

- The Serinus 30 Trace must be used in a laboratory environment which includes air conditioning to stabilise the temperature.
- A zero test should be performed over a 24 hour period to get an accurate reading of the Lowest Detectable Limit (LDL) of the entire system installation. Throughout this time

period 10 minute intervals should be used to collect readings of the CO from the zero air. From the data acquired the smallest detectable signal that can be accurately measured is found as well as the noise which determines the stability and precision of readings.

- A shut off valve should be designed into the sample manifold system, whereby the fan or pump used to draw in the sample air is turned off and the valve isolates the fan or pump from the sample manifold, when a calibration is in process (as ambient air is not required for calibration and will make calibration void). This valve can be controlled manually or via the data logger providing the data logger is designed with this function.

8.7.9 Trace Service and Maintenance

The maintenance intervals are determined by compliance standards that differ in various regions. The following is recommended by Ecotech as a guide. Compliance with local regulatory or international standards is the responsibility of the user. The below list only includes items that are different to a standard range instrument.

Table 16 – Maintenance Schedule

Interval *	Task performed	Section
Monthly	Replace particulate filter	6.4.1
	Check sample inlet system for moisture or foreign materials and clean	
6 Monthly	Perform multipoint precision check	5.7

* Suggested intervals for maintenance procedure are a guide only and may vary with sampling intensity and/or environmental conditions. Refer to a local regulatory standard for a personalised maintenance schedule.

8.8 External CO₂ Sensor (PN: E031014)

8.8.1 Introduction

The external CO₂ sensor option enables the Serinus 30 to report CO₂ concentration readings in addition to the standard CO measurements made by the Serinus 30. The CO₂ measurements are made using an external sensor, which is connected via an analog input to the Serinus 30.

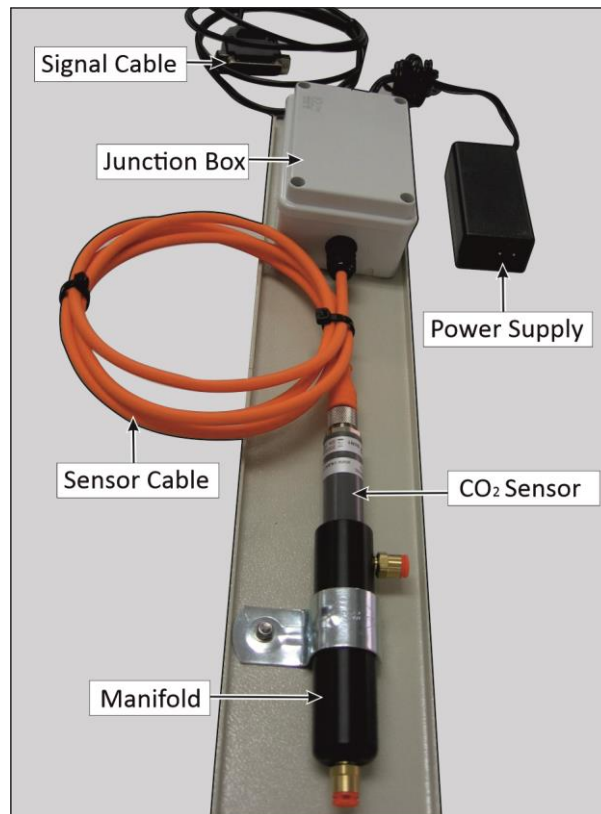

Figure 156 – External CO₂ Sensor

8.8.2 Specifications

Part number:	E031014
CO ₂ measurement range:	0 – 2000 ppm
Accuracy:	± (1.5% of range + 2% of reading) Including repeatability, non-linearity, and calibration uncertainty. At 25 °C and 1013 hPa
Temp. dependence, typical:	-0.3% of reading / °C
Pres. dependence, typical:	+0.15% of reading / hPa
Long term stability:	< ± 5% FS / 2 years
Response time, typical:	30 seconds
Warm up time:	15 minutes

Sensor output:	0 - 5 VDC
Sensor range:	0 - 2000 ppm (others available)
Power consumption:	< 2.5 W
Operating temperature	0 - 40 °C
Operating pressure:	700 - 1300 hPa
Oper. humidity probe:	0 - 100% RH non condensing
Oper. humidity circuit board:	0 - 85% RH non condensing
Mounting:	2RU (88.9 mm high) 19" rack mounted panel suits 19" rack mounting
Inlet / outlet fittings:	1/4" quick-connect push-in fittings

8.8.3 Equipment Required

- 1/4" tubing such as Teflon tube will be required to connect the probe to a sample manifold.

8.8.4 Installation

Electrical Connections

The CO₂ sensor must be installed within an air conditioned room. The sensor output varies slightly with temperature and pressure (refer specifications Section 8.8.2).

Connect the signal cable to the 25-way connector on the rear of the CO analyser as shown in Figure 157.

Connect the power supply to a power outlet and switch the power ON.

Note: The plug pack supplied is universal AC input and 12 VDC output. The acceptable power supply range is 11 - 20 VDC on +L terminal (refer to Figure 157). A second terminal labelled +H is provided that allows the sensor to be powered from 24 VDC supply (18 - 30 VDC range) if required.

An analog (voltage) output is pre-wired with a cable and 25-pin male connector. The output is 0 - 5 VDC corresponding to a range of 0 - 2000 ppm. Other higher ranges are available from the manufacturer – consult Ecotech for information.

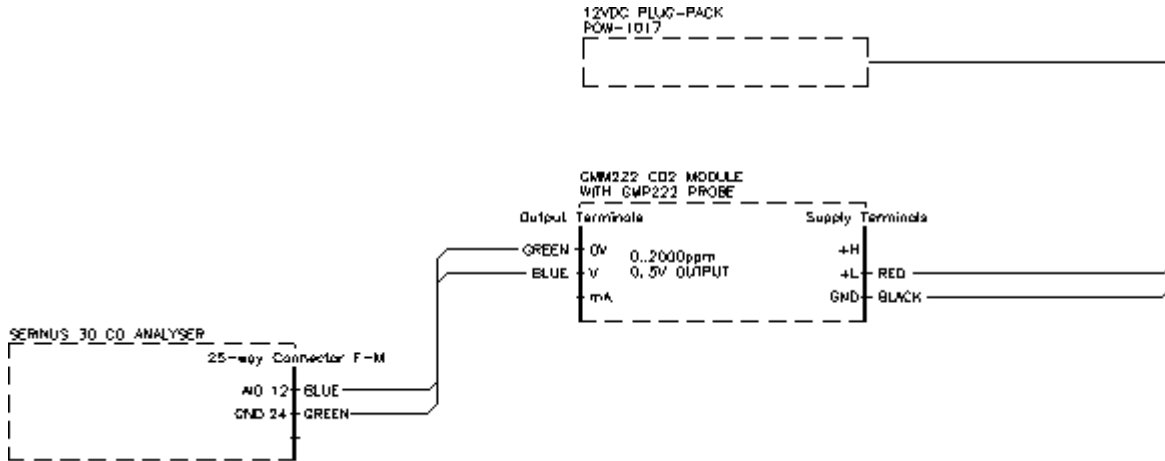

Figure 157 – Wiring Connections - CO₂ Probe to CO Analyser

Plumbing Connections

The CO₂ sensor does not restrict the flow in any way, so it can be connected either:

1. In-line between a sample manifold and the CO analyser; or
2. With its own sample pump and tube connections.

The direction of flow through the sensor is not critical. Use a piece of 1/4" O.D. Teflon tube to make the connections. It is not usually necessary to pre-filter the sample entering the CO₂ sensor. The CO₂ sensor probe has its' own replaceable filter. As the flow through the filter is diffuse and not high flow, this filter should have a long service life in most installations. The filter is available as a spare part if required.

It is important to check that the sensor probe is fully inserted into its black housing and ensure it is sealed gas tight.



Figure 158 – Example of installed CO₂ Sensor

Firmware Configuration

1. Press - (the green instrument status light), this will take the user to the home screen.
2. Press - (-99+) on the keypad. This will open the **Advanced Menu**.

-
3. Open - **Advanced Menu** → **Hardware Menu**.
 4. Enable - **Input 1 is CO₂** → **Enabled**.
 5. The Home Screen will now show both CO and CO₂.
 6. Open - **Main Menu** → **Communications Menu** → **Analog Input Menu**.
 7. Set **Input 1 Multiplier** to 400.
 8. Ensure **Input 1 Offset** is set to 0.
 9. The Serinus 30 is now configured to also read CO₂ from the external CO₂ option.

8.8.5 Operation

Main Screen

With the CO₂ External option installed as per Section 8.8.4, the main screen will show CO in the units specified by the user. CO₂ will always be shown in units of ppm.

Logging CO₂

To log CO₂ data, to the internal USB stick, the user will need to follow the below procedure:

1. Open - **Main Menu** → **Communications Menu** → **Data Logging Menu**
2. Select - **Data Log Setup - Numeric** option for data log setup.
3. Select - **Parameter 2** → **Edit** → Change it to parameter 54.

To log CO₂ data via a remote logging program, you will need to request parameter 54 for CO₂ (parameter 53 continues to return average CO). Refer to Table 33 for other parameter details.

8.8.6 Maintenance

The sensor probe is interchangeable. It can be removed, re-attached, or replaced easily at any time without the need for calibration and adjustment. The measurement range can also be changed by replacing the probe with a different range.

For minor calibration adjustments, the offset and multiplier can be changed in the CO analyser. Refer to Section 8.8.4 **Firmware Configuration**, for details of how to set an offset. It should not be necessary to adjust the offset but it can be useful to match individual sensors to each other.

Refer to Table 26 for spare part list.

8.8.7 Troubleshooting

The sensor is a rugged design but if it is knocked harshly the optical components may become misaligned. If the signal is noisy or suspected inaccurate, verify correct operation using a reference gas containing 300 – 1000 ppm of CO₂ in air.

A replacement probe can be purchased from Ecotech if required. Request CO₂ probe to suit part E031014.

9. Parts List and Schematics

9.1 Serinus Accessories Kit

This kit contains assorted fittings, tubing and an orifice removal tool which are useful when working on the instruments internal pneumatics. This is usually purchased with the instrument.

Table 17 – Serinus Accessories Kit – (PN: H010136)

Serinus Accessories Kit:	Part Numbers	Quantity
Fitting Nut 1/4T KYNAR Plug	036-130440-2	4
Fitting, Kynar, Union Tee 1/8 Barb - 400 Series	F030007-01	4
Fitting, Kynar, Union 1/8 Barb	F030008	2
Adaptor, 1/4" Fitting To 1/8" Barb	H010007	4
Adaptor, 1/4" Tube To 1/8" Barb	H010008	2
Tool, Extraction Orifice and Filter	H010046	1
Cap, Black Rubber, 1/8	H030003	4
Cap, Black Rubber, 1/4	H030004	4
Tubing, 1/4" OD, 1/8" ID Black Norprene	T010021	3.3 ft
Ecotech Tubing 1/4 X 1/8, Flexible Silicone W/ Kynar Lining	T010026	3 ft

9.2 Maintenance Kit

This maintenance kit is required when performing annual maintenance on the instrument. Depending on the environment the instrument is operating, this maintenance may need to be carried out more often than yearly.

Table 18 – Serinus 30 Maintenance Kit – (PN: E020202)

Part Description	Part Number
Stainless Steel Sintered Filter	F010004
23 Micron DFU	F010005
Spring Compression, 0.24 DIA	H010040
Viton O-Ring	O010008
O-Ring (0.364 ID X 0.070 W)	O010010
Viton O-Ring (0.114 ID X 0.07 W)	O010012
O-Ring (5/32 ID X 1/16 W (BS007))	O010013
Viton O-Ring (1 11/16 ID X 3/32 W)	O010014
Viton O-Ring (1/4 ID X 1/16 W)	O010015
Viton O-Ring (13/16 ID X 1/16 W)	O010016

Part Description	Part Number
Viton O-Ring (BS015)	O010023
O-RING, 1.989ID x 0.07W	O010054
O-Ring (BS110)	ORI-1009
Ecotech Tubing 1/4 X 1/8	T010026

9.3 Consumables

Parts shown as consumables below will require replacement over the course of the instrument's lifespan.

Table 19 – Serinus 30 Consumables

Part Description	Part Number
47 mm, 5 micron, Teflon Filter Paper, Pack of 50	F010006-01
47 mm, 5 micron, Teflon Filter Paper, Pack of 100	F010006
CO-CO ₂ Converter	H014130
#14 Orifice – Used in the Measurement Cell	H010043-13
Stainless Steel Sintered Filter	F010004
DFU Filter, 23 Micron	F010005
External Pump Repair Kit (To Suite a 607 Pump)	P031001
Internal Pump Repair Kit (to suit KNF Pump)	P031005
Tubing, 1/4" and 1/8" 25 ft Length	T010026-01

***Warranty Disclaimer:** The product is subject to a warranty on parts and labour from date of shipment (the warranty period). The warranty period commences when the product is shipped from the factory. **Lamps, fuses, batteries and consumable items are not covered by this warranty.** Subject to variable ambient conditions, toxic gases, dirt, extremes of temperature and moisture ingress may shorten the lifespan of components.

9.4 Instrument Parts List

List of Serinus 30 components and part numbers for reference:

Table 20 – Spare Parts List (Main Components)

Part Description	Part Number
Main Controller PCA	E020230-01
DFU Filter, 23 Micron	F010005
Calibration Valve Manifold	H010013-01
Rear Panel PCA	C010002-01

Part Description	Part Number
Chassis Fan	C020058
Chassis Fan filter Kit	H010044
Front Panel Assembly	H010130
Sample Filter Holder	H010160
Power Supply	P010013
Measurement Cell Assembly	H014100
Pressure Sensor PCA (Measurement Cell)	C010004
CO & CO ₂ Detector PCA	C010009
Sintered Filter (Measurement Cell)	F010004
Gasket for Pressure Sensor PCA	H010037
Compression Spring (Measurement Cell)	H010040
#14 Orifice - Used in the Measurement Cell	H010043-13
Detector to cell adaptor (Measurement Cell)	H014106
Sapphire Window	H014111
Source Timing Assembly	H014125-30
Motor Adaptor Plate (Source Timing Assembly)	H014102
Correlation Wheel Assembly (Source Timing Assembly)	H014114-30
IR Source Assembly (Source Timing Assembly)	H014201-30
Motor Assembly (Source Timing Assembly)	M020006-30
Opto Detector (Source Timing Assembly)	S030002-30
Narrow Bandpass Filter (Detector Assembly)	H014205
IR Detector (Detector Assembly)	S030005-30
CO-CO ₂ Converter Assembly	H014130
Thermal Fuse and Heater	C020082
Heater Thermistor Assembly	C020073
CO-CO ₂ Converter End Plate	H014134
Compression Spring (CO-CO ₂ Converter)	H030073

Table 21 – Spare Parts List (Cables)

Part Description	Part Number
Motor / OPTO / Lamp Cable	C020055-01
Detector (PREAMP) Cable	C020061-01
Pressure Sensor Cable	C020062-01
Display Cable	C020065
Analog & Digital I/O Cable	C020066

Part Description	Part Number
Heaters & Thermistors Cable	C020070
Bluetooth Cable	C020119

Table 22 – Spare Parts List (O-rings)

Part Description	Part Number
O-ring, 1/4 ID X 1/16 W (Calibration Valve Manifold)	O010015
O-ring, 1.989 ID x 0.07 W (Sample Filter)	O010054
O-ring, 0.364 ID X 0.070 W (IR Filter Sealing)	O010010
O-ring, 0.114 ID X 1/16 W (for Sintered Filter Sealing)	O010012
O-ring, 5/32 ID X 1/16 W (for Orifice)	O010013
O-ring, BS015 (for Window)	O010023
O-ring, BS110 (Bulkhead Sealing)	ORI-1009

Table 23 – Spare Parts List (Fittings)

Part Description	Part Number
Kynar Union Fitting	F030022
1/4" PTEF Straight Ferrule	F030028
Nut 1/4T Steel Gripper Fitting	F030029
M4 X 15 Standoff	F050015
Slotted Head Screw	F050038
Kynar Bulkhead Union Fitting	F030023
Kynar Male Elbow Fitting	F030032-02
Kynar Plug 1/8 NPT (Source Timing Assembly)	HAR-3660
Male Connector Fitting	F030006-01
Kynar Male Connector Fitting 1/4T, 1/8 NPT (refer to Section 9.13, callout no. 6)	F030020
Kynar Male Connector Fitting 1/4T, 3/8 NPT (refer to Section 9.13, callout no. 3)	F030021
M4 Split Spring Washer	FAS-M4ZP-21
M4 Flat Washer	FAS-M4ZP-22
1/4" to 1/8" Adaptor Fitting	H010007

Table 24 – Spare Parts List (Miscellaneous)

Part Description	Part Number
PCB Support Bracket	H010011-01
9/16" High Foot Bumper	H010039
Black Blanking Plug	H010041
Front Panel Clearance Spacer	H010064
Rectangular Blanking Plug	H010067
Circuit Board Support Bracket	H010111
Sample Filter mounting Plate	H010126
Roller Bearing	H010131
Power Supply Bracket	H010138
Rear Panel	H010142
Push Button Slam Lock	H030114
Nylon P Clip, 1/2" (12.7Mm)	H030149
Circuit Board Support Bracket	H010117
Serinus 30 CO Label	H010132-03
Correlation Wheel Cover	H014103
CO Detector Cover	H014126
CO-CO ₂ Converter Angle Bracket	H014138
8 GB USB Memory Stick	H030021
Shock Mount Rubber	H030074
Cable Tie Mount	H030076
Cable Tie Mount 11.4	H030077
Cable Clip Mount 13.5 X 14 mm (L X H)	H030121
Cable Clip Mount 10 X 17.5 mm (L X H)	H030122
1/4" X 1/8" Tubing	T010026
USB Cable	COM-1440
Thumb Screw (Rear Panel)	F050037
Thumb Screw (Main Controller PCA)	F050120
Product Resources USB key	H030137

Table 25 – Spare Parts List (Shipping)

Part Description	Part Number
Shipping Box	B010002
End Caps (Pair)	B010026

Part Description	Part Number
Mid Cap	B010034
Plastic Bag 760 X 1000 50 X UM	B020001
Desiccant Pack (25 gm)	C050012

Table 26 – Spare Parts List (External CO₂ Sensor)

Part Description	Part Number
Power Lead	C040002
Connector Fitting 1/4T	F030055
Sealing Plug M5	F030079
Scrubber Support Ring, #35	H010143
Support Ring #25, 25 - 28 mm	H010147
Spacer 2.5 mm	H010148
Spacer 5.0 mm	H010149
Nylon P Clip 1/2" (12.7 mm)	H030149
CO ₂ Sensor	S031040
Manifold	S031040-01
Porous Sintered PTFE Filter for GMP252	DRW244221SP

9.5 Plumbing Schematic – (PN: D020005)

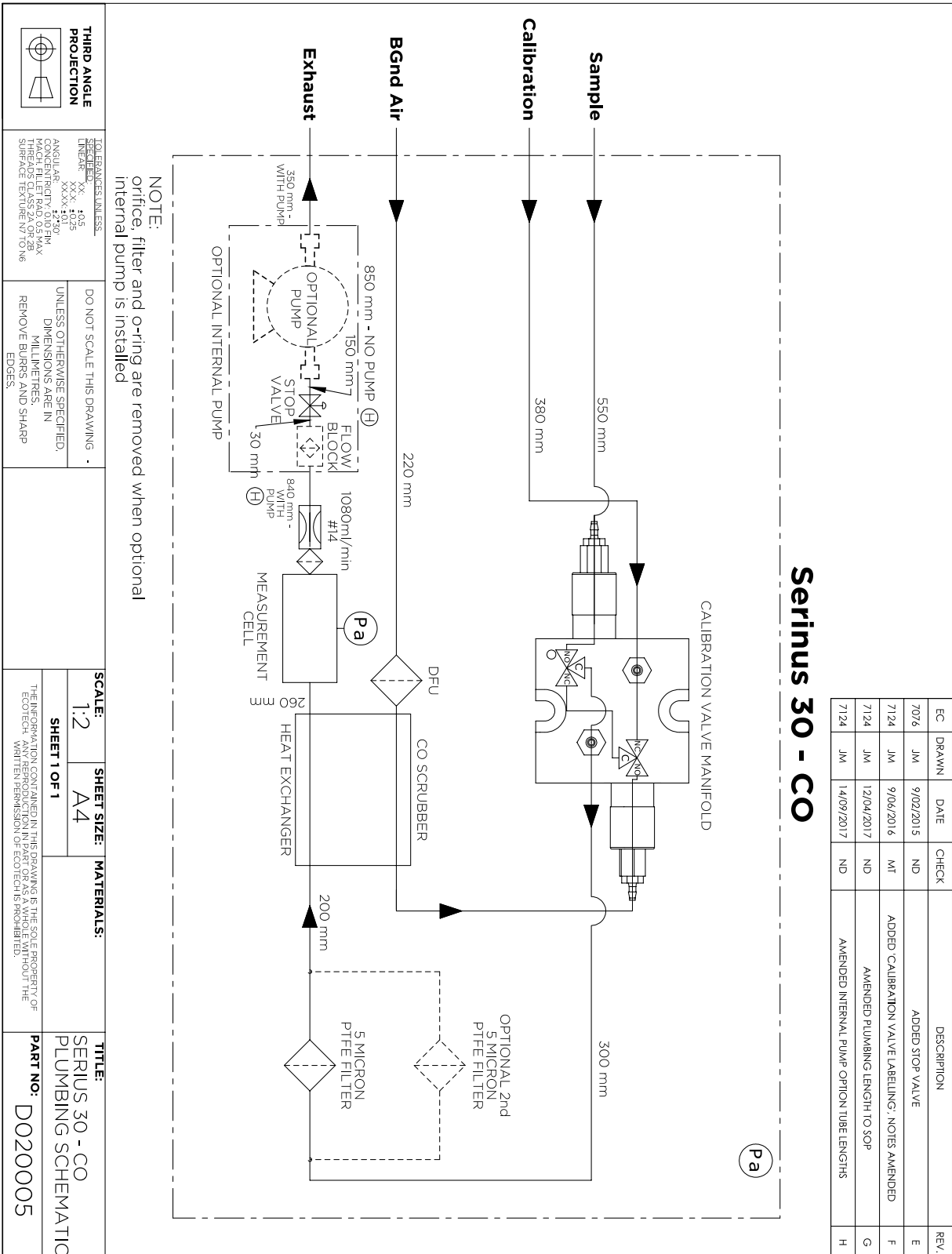

9.6 Block Wiring Schematic – (PN: D020102)

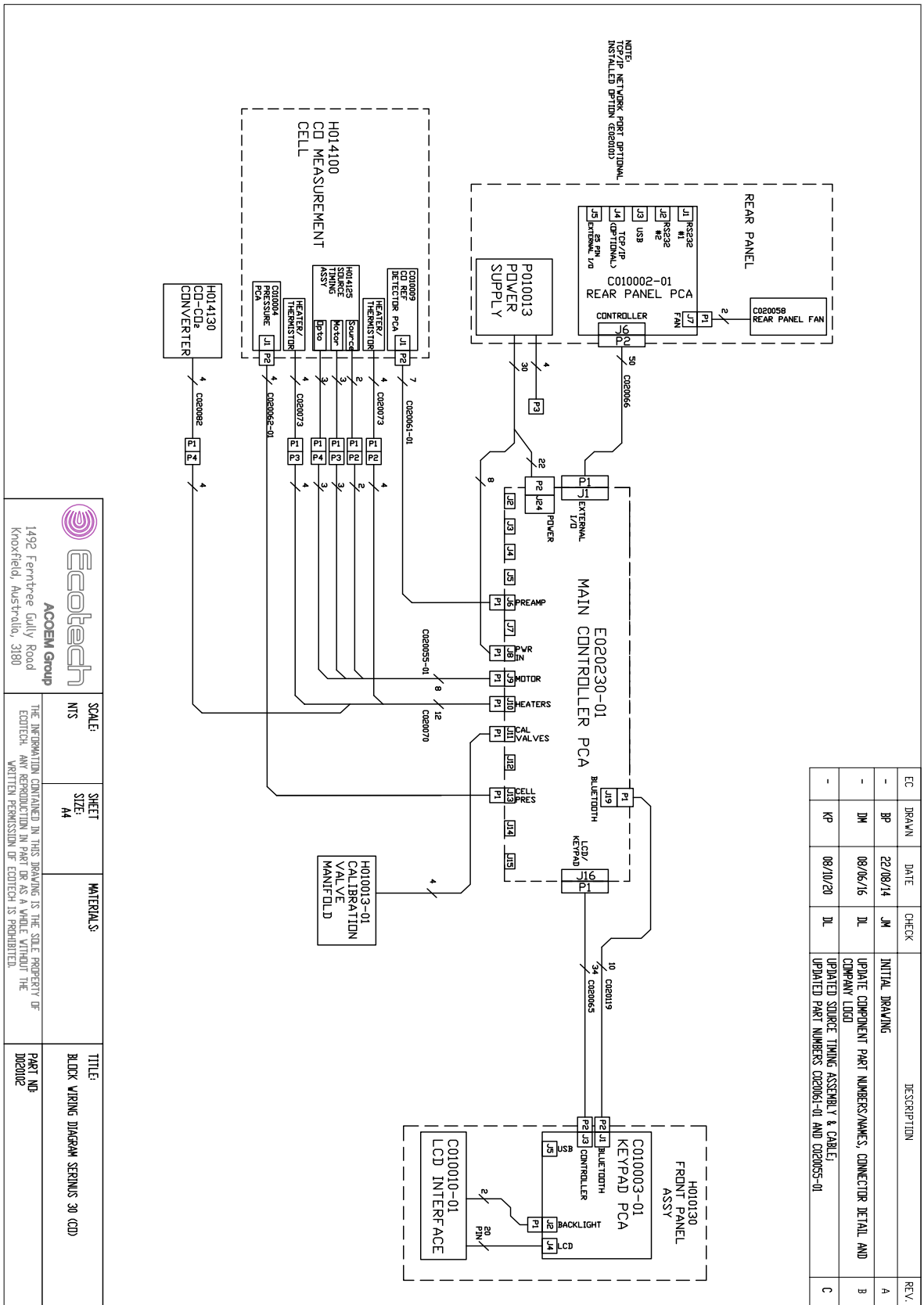

 Ecotech ACOEM Group	SCALE:	SHEET:	MATERIALS	TITLE:
	MMS	SIZE:		
1492 Ferntree Gully Road Knoxfield, Australia, 3180		M4		PART NO:
THE INFORMATION CONTAINED IN THIS DRAWING IS THE SOLE PROPERTY OF ECOTECH. ANY REPRODUCTION IN PART OR AS A WHOLE WITHOUT THE WRITTEN PERMISSION OF ECOTECH IS PROHIBITED.				D020102

9.7 Measurement Cell – (PN: H014100)

ITEM NO.	PART NUMBER	DESCRIPTION	QTY.
1	H014110	CO CELL BASIC ASSY	1
2	F050010	M3X10 SEMS PAN HEAD PHILLIPS SCREW	7
3	F050006	HEX SPACER M3 X 10MM, 5MM STUD BRASS NICKLE PLATED/MALE/FEMALE	4
4	CO10009	PCA CO DETECTOR GAS ANALYZER	1
5	F050024	M4 X 30 SEMS	4
6	F050011	M3X6 SEMS PAN HEAD PHILLIPS SCREW	4
7	H010037	GAS/EL PRESSURE SENSOR	1
8	H014103	COVER CORRELATION WHEEL	1
9	H014125	MOTOR, OPTO, LAMP, ADAPTOR PLATE & CO-RELATION WHEEL ASSLY	1
10	CO10010	O-RING 0.364ID X 0.070W, 85012 VITON	1
11	H014106	ADAPTOR, SENSOR TO CELL, CO	1
12	H014205	FILTER/INRARED CO BAND -45°C	1
13	S030005	DETECTOR LEAD SELENDI, 4.7MI	1
14	FAS-M3SS-12	M3X12 CSK SCREW, HEX DRIVE	2
15	H014126	COVER SENSOR, CO	1
16	F050012	M4 X 10 SEMS	4
17	F030023-NO CAP	FITTING KYNAR BULKHEAD UNION	1
18	CO10012	O-RING 5/32ID X 1/16W, VITON	1
19	H010043-13	ORIFICE 1.4 MIL	1
20	H010007	ADAPTOR, 1/4" FITTING TO 1/8" BARB	2
21	ORI-1009	ORING, BS-110, VITON	1
22	F010004	FILTER SINTERED SS	1
23	H010040	SPRING COMPRESSION, 0.24 DIA 0.530 LENGTH	1
24	CAP	FITTING KYNAR BULKHEAD UNION	1
25	H014212	GASKET	1
26	H014211	COVER PLATE	1
27	CO10004	PCA, PRESSURE GAUGE, GAS ANALYZER	1
28	CO10013	O-RING 5/32ID X 1/16W, VITON	1
29	F030032-02	FITTING KYNAR MALE ELBOW 1/4T - 1/8NPT	1
30	3 mm/10	WASHER, FLAT, M3 x 10mm, ZP	1
31	PH3BY6	M3X6 PAN HEAD PHILLIPS SCREW	1
32	CO20073	HEATER & THERMISTOR ASSEMBLY	2
33	H014111	WINDOW, SAPPHIRE, CO, SERINUS	1
34	CO10023	O-RING 85038, SILICONE	1
35	H01421505	HEAT SINK, DETECTOR, CO, SERINUS	1
36	F050018	M3X10 SEMS PAN HEAD PHILLIPS SCREW	2

EC	DRAWN	DATE	CHECK	DESCRIPTION	REV.
	JM	13/03/2015	MT	ADDED F030005 XI TO BOM	C
	JM	21/09/2015	ND	001001.3 WAS CO10012	D
	JM	31/12/2015	ND	AS PER EC	E
	JM	31/05/2016	ND	NEW WINDOW AND GASKING AS PER EC	F
	JM	19/06/2018	VC	ADDED HEAT SINK AS PER EC, SCREWS NOW M3X6 SEMS PAN HEAD	G
	JM				G

<p>THIRD ANGLE PROJECTION</p>	<p>DESIGNED/ENGINEERED:</p> <p>BRUCE, JOE, 015-850-3333</p> <p>DATE: 03/03/2015</p> <p>CONFORMS TO THE MACHINING SPECIFICATIONS AND SURFACE FINISH TO DWS</p>	<p>DO NOT SCALE THE DRAWING</p> <p>FINISH ON HIDDEN SURFACES, REMOVE RIBS AND SHARP EDGES</p>	<p>Ecotech</p> <p>14827 Perrine, Glen Head, New York, NY 11545</p>	<p>SCALE: 1:1</p> <p>SHEET 1 OF 1</p> <p>REVISIONS: ANY REVISIONS IN PARTS OR ASSEMBLY WHICH AFFECT THE FUNCTION OR PERFORMANCE OF THE PART OR ASSEMBLY MUST BE APPROVED BY THE WRITER, REVISIONS OF ECOTECH IS APPROVED.</p>	<p>TITLE:</p> <p>CO CELL FINAL ASSEMBLY, SERINUS</p> <p>PART NO: H014100</p>
-------------------------------	---	---	---	---	--

9.8 Source Timing Assembly – (PN: H014125)

EC	DRAWN	DATE	CHECK	DATE	DESCRIPTION	REV.
-	V.C.	15/01/08	M.S.		INITIAL DRAWING	A
6962	VC	6/4/10			PART NUMBEER UPDATED AS PER NEW PART NUMBERING SUYSTEM	B
	BP	22/08/2014	JM		PART NUMBERS UPDATED	C
7145	JM	23/06/2016	ND		MOTOR CHANGED. H014104 REMOVED	D
7387	SKS	01/02/2021	JAM	02/02/2021	FASTENERS QUANTITY & MOTOR ASSEMBLY UPDATED	E

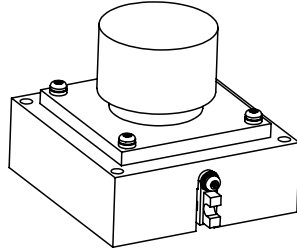
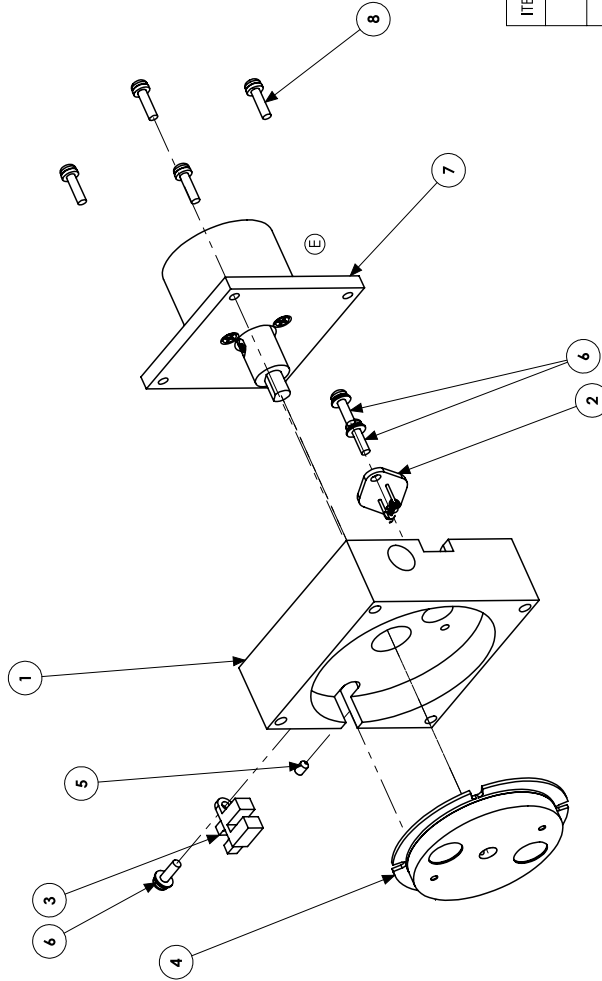

ITEM NO.	PART NUMBER	DESCRIPTION	QTY.
1	H014102	ADAPTOR PLATE, MOTOR AND CORRELATION WHEEL	1
2	H014201	SOURCE ASSY CLEANED / BURNED-IN	1
3	S030002	OPTO. SENSOR, SLOTTED SERINUS	1
4	H014114	CORRELATION WHEEL, CO	1
5	FAS-M3BS-2	M3 x 4 GRUB SCREW KNURLED CUP POINT	1
6	F050010	M3X10 SEMS PAN HEAD PHILLIPS SCREW	3
7	M020006-01	MOTOR ASSEMBLY, CORRELATION, SERINUS	1
8	F050011	M3X12 SEMS PAN HEAD PHILLIPS SCREW	4

SCALE:		SHEET SIZE:		MATERIALS:		TITLE:	
1:2	A4	--	--	SOURCE TIMING ASSLY			
SHEET 1 OF 1				PART NO: H014125			
<p>DO NOT SCALE THIS DRAWING</p> <p>UNLESS OTHERWISE SPECIFIED, DIMENSIONS ARE IN MILLIMETRES. REMOVE BURRS AND SHARP EDGES.</p> <p>UNLESS OTHERWISE SPECIFIED, TOLERANCES UNLESS SPECIFIED: LINEAR: XX.XX, XX.X, XX.XX ANGULAR: XX.XX, XX.X, XX.XX</p>							
<p>THIRD ANGLE PROJECTION</p>							
<p>ECOTECH</p> <p>1492 Ferntree Gully Road Knoxfield, Australia, 3180</p>							
<p>THE INFORMATION CONTAINED IN THIS DRAWING IS THE SOLE PROPERTY OF ECOTECH. ANY REPRODUCTION IN PART OR AS A WHOLE WITHOUT THE WRITTEN PERMISSION OF ECOTECH IS PROHIBITED.</p>							

9.9 Calibration Manifold Assembly – (PN: H010013-01)

VALVE 1
CABLE LENGTH 190 mm
CONNECT TO PINS 1 AND 6
ON THE CONNECTOR

VALVE 2
CABLE LENGTH 250 mm
CONNECT TO PINS 2 & 7
ON THE CONNECTOR

CABLE TIE
2-PLACERS

MICROFIT RECEPTACLE
FREE TO WAY MOLEX

NOTES:

1. VALVES MUST BE FREE OF DIRT, GREASE OR ANY OTHER FOREIGN MATERIAL.
2. F030006-01 THREADS MUST BE SEALED WITH SWAGELOK THREAD TAPE.
3. MANIFOLD BLOCK MUST BE FREE OF DIRT, GREASE OR ANY OTHER FOREIGN MATERIAL.
4. ASSEMBLY MUST PASS LEAK TEST UNDER VACUUM OF -90 KPA. MAX DROP ALLOWED IS 2 KPA IN 5 MINS.

EC	DRAWN	DATE	CHECK	DESCRIPTION	REV.
	VC	16/03/10		INITIAL DRAWING	X1
	BP	22/08/2014	JM	BOM ADDED	B
	ND	9/11/2015	JM	COMPANY LOGO UPDATED IN TITLE BLOCK	C
7154	JM	3/05/2016	ND	FITTING CHANGED AS PER EC	D

ITEM NO.	PART NUMBER	DESCRIPTION	QTY.
1	H010014-01	VALVE MANIFOLD	1
2	H010042	VALVE MFLD, 3 WAY, 12VDC	2
3	F030006-01	FITTING, MALE CONNECTOR 1/8NPT - 1/8 BARB, KYNAR	4

SCALE: NTS
SHEET SIZE: A4
SHEET 1 OF 1

MATERIALS: AS NOTED

TITLE: CALIBRATION VALVE MANIFOLD
PART NO: H010013-01

DO NOT SCALE THIS DRAWING
UNLESS OTHERWISE SPECIFIED, DIMENSIONS ARE IN MILLIMETERS. REMOVE BURRS AND SHARP EDGES.

THIRD ANGLE PROJECTION

TOLERANCES UNLESS SPECIFIED:
LINEAR: XX: ±0.5
XXX: ±0.25
ANGULAR: XXXX: ±0.1
CONCENTRICITY: 0.101MM
SURFACE FINISH: CLASS X
THREADS: CLASS 2A OR 2B
SURFACE TEXTURE: RV TO V6

1492 Fernitee Gully Road
Knoxfield, Australia, 3180
ecotech

THE INFORMATION CONTAINED IN THIS DRAWING IS THE SOLE PROPERTY OF ECOTECH. ANY REPRODUCTION IN PART OR AS A WHOLE WITHOUT THE WRITTEN PERMISSION OF ECOTECH IS PROHIBITED.

9.10 Valve Assembly – (PN: H010042)

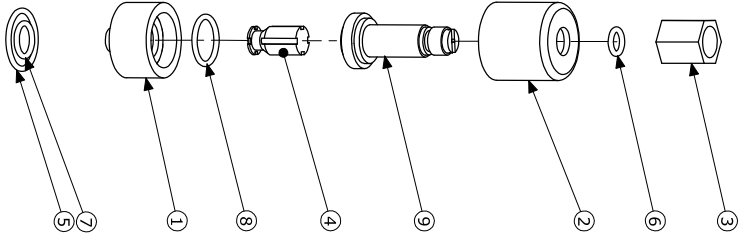

ITEM NO.	PART NUMBER	QTY.
1	BODY	1
2	SOLENOID COIL	1
10	NUT	1
4	PLUNGER	1
5	O010016	1
6	O010015	1
7	O010010	1
8	O010023	1
9	STEM	1

STEPS TO REPLACE O-RINGS:

1. MARK THE SOLENOID COIL WITH A PERMANENT MARKER TO IDENTIFY THEIR RESPECTIVE VALVES AND THEIR POSITION ON MANIFOLD BLOCK
2. SECURE THE 3-WAY VALVE UPRIGHT INTO A LARGE VICE WITH PROTECTION AROUND ITS BODY TO PREVENT SCATCH OR DAMAGE TO VALVE
3. REMOVE NUT FROM THE TOP OF THE 3-WAY VALVE USING A 9/16" SPANNER
4. REMOVE SMALL O-RING FROM AROUND 3 WAY VALVE USING 2 MM FLAT SCREW DRIVER
5. LIFT OFF THE SOLENOID COIL FROM THE 3-WAY VALVE THEN UNCREW THE SHAFT FROM THE BASE USING A LARGE FLAT SCREW DRIVER. WHILE UNSCREWING TAKE CARE THAT THE INTERNAL PLUNGER DOES NOT FALL OUT
6. REPLACE THE INTERNAL O-RING WITH O010023
7. ASSEMBLE THE SHAFT ALONG WITH PLUNGER BACK IN ITS POSITION
8. ASSEMBLE THE SOLENOID WITH ITS RESPECTIVE VALVE
9. ASSEMBLE NEW O010015 O-RING SUPPLIED
10. ASSEMBLE THE NUT ON TOP OF 3-WAY VALVE.
11. ASSEMBLE O010016 AND O010010 O-RING SON THE BOTTOM OF THE VALVE.
12. ASSEMBLE VALVE BACK IN MANIFOLD BLOCK

H010042
3 WAY VALVE SERVICE PROCEDURE

9.11 High Pressure Valve Exploded View – (PN: H050043)

EC	DRAWN	DATE	CHECK	DESCRIPTION	REV.
	JM	04/12/2015	ND	INITIAL ISSUE	A
	JM	7/08/2018	VC	ADDED M12 WASHERS AND NOTES FOR MOUNTING	B

INSTRUMENT TYPE	ORIFICE PART NO.
S10 (O3)	H010043-09
S30/S31 (CO / CO2)	H010043-13
S40 (NOX)	H010043-11
S40H (NOX HIGH LEVEL)	H010043-03
S44 (NH3/NOX)	H010043-11
S5X (SO2, H2S/SO2, H2S, TS, TRS)	H010043-13

NOTES: (B)
 1. FITTING TO BE MOUNTED FROM OUTSIDE OF INSTRUMENT IN FOLLOWING ORDER: FITTING, INSTRUMENT REAR PANEL, STAR WASHER, FLAT WASHER, RETAINING NUT
 2. STAMPED 'V' ON FITTING DENOTES DIRECTION OF FLOW AND ORIENTATION OF VALVE
 3. ASSEMBLY TO MOUNTED WITH VALVE END INSIDE OF INSTRUMENT

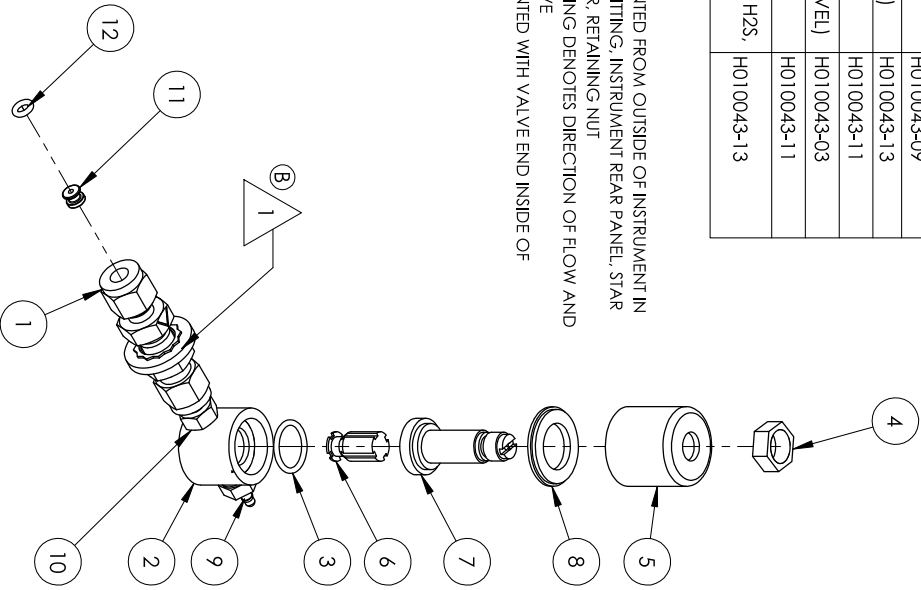

ITEM NO.	PART NUMBER	DESCRIPTION	QTY.
1	98300076	FITTING, BULKHEAD, 1/4T S/S, MODIFIED	1
2	BASE	BASE VALVE, 2 WAY, 12 VDC	1
3	O010023	O-RING BS038, SILICONE	1
4	NUT	NUT, VALVE, 2 WAY, 12 VDC	1
5	COIL	SOLENOID COIL, VALVE, 2 WAY, 12 VDC	1
6	PUNGER	PUNGER, VALVE, 2 WAY, 12 VDC	1
7	STEM	STEM, VALVE, 2 WAY, 12 VDC	1
8	WASHER	WASHER, VALVE, 2 WAY, 12 VDC	1
9	F030006-01	FITTING, MALE CONNECTOR 1/8NPT - 1/8 BARB, KYNAR	1
10	28590462-3	Male Adapter (Tapped Thread)	1
11	H010043-XX	ORIFICE	1
12	O010013	O-RING 5/32ID X 1/16W, VITON	1
13	F050131	M12 INTERNAL STAR WASHER	1
14	F050130	WASHER, FLAT, M12, SS	1

TOLERANCES UNLESS SPECIFIED:
 LINEAR: .005, .015, .030, .050, .100, .150, .300, .500, .750, 1.000
 ANGULAR: ±.01°
 CONCENTRICITY: .005 DIA
 MACH. FIN. SURF. RZ: 1.25 μm
 MACH. FIN. SURF. RY: 12.5 μm
 THREADS: CLASS 2A OR 2B MAX STRAIGHT LENGTH IN TO N6
 DO NOT SCALE THIS DRAWING UNLESS OTHERWISE SPECIFIED. DIMENSIONS ARE IN MILLIMETRES. REMOVE BURRS AND SHARP EDGES.

THIRD ANGLE PROJECTION

SCALE: 1:2
SHEET SIZE: A4
MATERIALS: AS PER BOM
TITLE: VALVE ASSY, HIGH PRESSURE, SERINUS
PART NO: H050043
 THE INFORMATION CONTAINED IN THIS DRAWING IS THE SOLE PROPERTY OF ECOTECH. ANY REPRODUCTION IN PART OR AS A WHOLE WITHOUT THE WRITTEN PERMISSION OF ECOTECH IS PROHIBITED.

Page 198

9.12 Sample Filter Holder Assembly – (PN: H010160)

ITEM NO.	PART NUMBER	DESCRIPTION	QTY.
1	H010161	BASE, SAMPLE FILTER, 47MM, SERINUS	1
2	H010152	CAP, SEALING, SAMPLE FILTER, SERINUS	1
3	H010153	SAMPLE FILTER 47MM RETAINING RING	1
4	O010054	O-RING, BS224, VITON	1
5	H010021	SAMPLE FILTER BRACKET	1
6	FAS-M4ZF-2	M4x8 ZP PAN PHILLIPS	2
7	F030006-01	FITTING, MALE CONNECTOR 1/8NPT - 1/8 BARB, KYNAR	1
8	F030032-02	FITTING KYNAR MALE ELBOW 1/4" - 1/8NPT	1
9	H010007	ADAPTOR, 1/4" FITTING TO 1/8" BARB	1
10	F010006-02	FILTER, PAPER, 47mm, 5 MICRON, PTFE	1

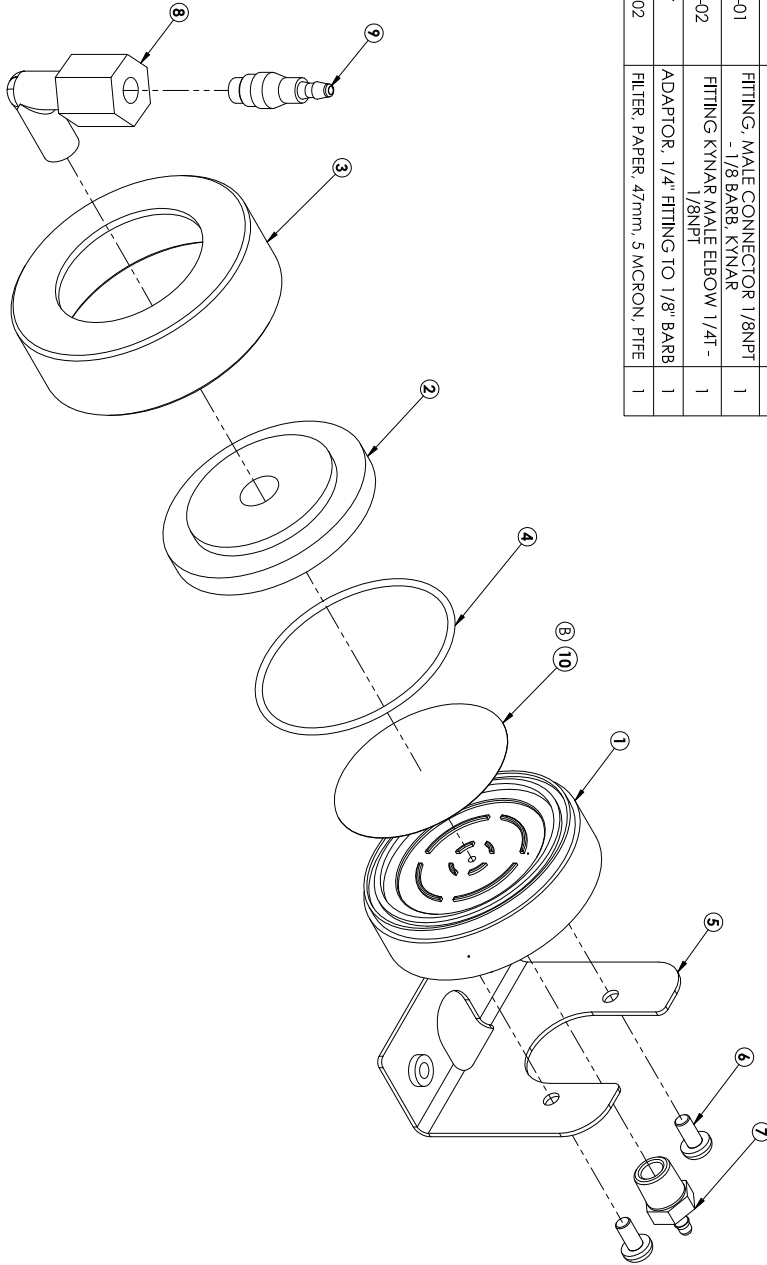

EC	DRAWN	DATE	CHECK	DESCRIPTION	REV
7151	JM	07/04/2018	VC	INITIAL DRAWING	A
7151	JM	17/01/2019	VC	ADDED MISSING FILTER F010006-02	B

<p>THIRD ANGLE PROJECTION</p>	<p>UNLESS OTHERWISE SPECIFIED, DIMENSIONS ARE IN MILLIMETRES. REMOVE BORES AND SHARP EDGES.</p>	<p>1402 Pittwater Circle, Rosel Newfield, Australia, 3800</p>	<p>SCALE: 1:1</p> <p>SHEET 1 OF 1</p>	<p>SHEET SIZE: A3</p> <p>MATERIALS:</p>	<p>TITLE: SAMPLE FILTER ASSY FACE SEAL, SERINUS PART NO: H010160</p>
-------------------------------	---	---	---------------------------------------	---	--

9.13 CO-CO₂ Converter Assembly – (PN: H014130)

EC	DRAWN	DATE	CHECK	DESCRIPTION	REV.
	JM	09/04/2015	ND	INITIAL DRAWING	A
7138/ 7154	JM	5/05/2016	ND	ADDED END RETAINING PLATES AS PER EC. CHANGE FITTING AS PER EC. F030032-02 WAS F030005	B
	JM	30/08/2018	VC	FITTING CHANGED. F030006-01 WAS F030032-02	C

ITEM NO.	PART NUMBER	DESCRIPTION	QTY.
1	H014202	BLOCK, CONVERTER, CO, SERINUS	1
2	H014203	SCREEN MESH 0.56	2
3	F030021	FITTING KYNAR MALE CONNECTOR 1/4" - 3/8 NPT SPRING COMPRESSION 0.24 DIA 0.630 MM WIRE	1
4	H030073	INSULATION, FOAM 98300023	1
5	Armaflex for 98300023	INSULATION, FOAM	1
6	F030020	FITTING KYNAR MALE CONNECTOR 1/4" - 1/8NPT	1
7	C020073	HEATER & THERMISTOR ASSEMBLY	1
8	H010007	ADAPTOR, 1/4" FITTING TO 1/8" BARB	1
9	C050010	BEADS, GLASS PYREX	
10	C050011	CATALYST	20 GR
11	F030006-01	FITTING, MALE CONNECTOR 1/8NPT - 1/8 BARB, KYNAR	2
12	53000177	HEATER 12VDC, 35W, 1/4OD X 1 1/2	1
13	H014134	END PLATE, RETAINING, CONVERTER, CO, SERINUS	2
14	F050012	M4 X 10 SEMS	4

THIRD ANGLE PROJECTION

UNLESS OTHERWISE SPECIFIED, DIMENSIONS ARE IN MILLIMETRES. REMOVE BURRS AND SHARP EDGES.

DO NOT SCALE THIS DRAWING

SCALE: 1:4

SHEET SIZE: A4

SHEET 1 OF 1

MATERIALS: SEE BOM

TITLE: CONVERTER ASSY, CO, SERINUS

PART NO: **H014130**

1492 Fernree Gully Road
Knoxfield Australia, 3180

Ecotech

TOLERANCES UNLESS OTHERWISE SPECIFIED:
 HOLE: .015
 LENGTH: .025
 ANGULAR CONCENTRICITY: .010 FINISH
 THREADED CLASS: A OR 2B
 SURFACE TEXTURE: N7 TO N6

This page is intentionally blank.

Appendix A. Advanced Protocol

The Advanced protocol allows access to the full list of instrument parameters.

A.1 Command Format

All commands and responses sent to and from the Instrument will be in the following packet format to ensure data is reliable.

Table 27 – Packet Format

1	2	3	4	5	6 ... 5+n	6+n	7+n
STX (2)	Serial ID	Command	ETX (3)	Message Length (n)	Message	Checksum	EOT (4)

Where:

- <STX> ASCII Start of Text = 0x02 hex.
- Serial ID The Serial ID assigned in the **Main Menu** → **Communications Menu** → **Serial Communication Menu**.
- <ETX> ASCII End of Text = 0x03 hex.
- Checksum The XOR of the individual bytes except for STX, ETX, EOT and Checksum.
- Message length Must be in the range 0 - 32. Responses from the instrument can have a message Length of 0 - 255.
- <EOT> ASCII End of Transmission = 0x04 hex.

Examples

A basic request for Primary gas data would be as follows:

Table 28 – Example: Primary Gas Request

Byte Number	1	2	3	4	5	6	7	8
Description	STX	ID	Command	ETX	Message Length	Primary Gas Conc	Checksum	EOT
Value	2	0	1	3	1	50	50	4
Checksum Calculation		0	$0 \oplus 1 = 1$		$1 \oplus 1 = 0$	$0 \oplus 50 = 50$	50	

And a sample response:

Table 29 – Example: Primary Gas Response

Byte Number	1	2	3	4	5	6	Continued in next table.
Description	STX	ID	Command	ETX	Message Length	Primary Gas Conc	
Value	2	0	1	3	5	50	
Checksum Calculation		0	$0 \oplus 1 = 1$		$1 \oplus 5 = 4$	$4 \oplus 50 = 54$	

Table 30 – Example: Primary Gas Response (Continued)

Byte Number	7	8	9	10	11	12
Description	IEEE representation of 1.00				Checksum	EOT
Value	63	128	0	0	50	4
Checksum Calculation	$54 \oplus 63 = 9$	$9 \oplus 128 = 137$	$137 \oplus 0 = 137$	$137 \oplus 0 = 137$	137	

A.2 Commands

Communication Error

Where:

Command byte 0
 Message byte 1 0
 Message byte 2 0..7

If the command byte of a response is 0, this indicates an error has occurred. The message field will be 2 bytes long, where the 2nd byte indicates the error according to the following table.

Table 31 – List of Errors

Error #	Description
0	Bad Checksum received
1	Invalid Parameter Length
2	Invalid Parameter
3	Internal Data Flash Erase in Progress unable to return data for a few seconds
4	Unsupported Command.
5	Another process is collecting data – unable to service request.

Error #	Description
6	MemStick No Connected
7	MemStick Busy

Get IEEE Value

Where:

- Command byte 1
- Message byte 1 Index from List of Parameters
- Message byte 2..32 Additional indexes (optional)

This command requests the value of an instrument parameter. The message field byte contains the index of the parameter requested, as described in the List of Parameters.

Up to 32 indexes can be supplied in a single request. The response has 5 bytes for each parameter requested – the first byte is the parameter index and the next four are the IEEE representation of the current value.

Example

A request with a message field of 50,51,52 to a Serinus S40 would return a 15 byte message as shown below:

Table 32 – Example: Get IEEE Response data

1	2	3	4	5	6	7	8	9	10	11	12	13	14	15
50	NO reading				51	NOx reading				52	NO2 reading			

Set Calibration Mode

Where:

- Command byte 4
- Message byte 1 85
- Message byte 2 - 5 The IEEE representation of 0, 1, 2, or 3
 - 0 puts the instrument into Measure mode (0,0,0,0)
 - 1 puts the instrument into Cycle mode (63,128,0,0)
 - 2 puts the instrument into Zero mode (64,0,0,0)
 - 3 puts the instrument into Span mode (64,64,0,0)

This command puts the instrument into a calibration mode (the same as going to the Calibration menu and choosing a Cal. Mode).

Example

A request with a command of 4 and a message field of 85,64,64,0,0 would place the instrument into Span mode.

Set Calibration

Enters a new calibration value: the same as entering Span Calibrate or Zero Calibrate on the calibration menu.

Where:

Command byte 18

Message byte 1 0, 1, 2, or 3 where
 0 = Span
 1 = Zero (first zero gas)
 2 = Zero (second zero gas)
 3 = Zero (Third zero gas)

Message byte 2 - 5 The IEEE representation of the calibration value.

A.3 List of Parameters

Note: Parameters are for all Serinus series analysers and may not be applicable to an individual instrument.

Table 33 – Advanced Protocol Parameter List

#	Description	Notes
1	Cal/Zero Valve	0 = Zero, 1 = Cal
2	Internal Span Valve	0 = OFF, 1 = ON
3	+Analog Supply	Positive analog supply voltage
4	Gas 5 Avg.	Average of the readings (for Gas5) of the last n minutes where n is the averaging period E.g. Nx
5	Pregain	S30H linearization coefficient gain
6	Sample/Cal Valve	0 = Sample, 1 = Cal/Zero
7	NOx Measure Valve	0 = NO, 1 = NOx
8	NOx Bypass Valve	0 = NO, 1 = NOx
9	NOx Backgnd Valve	0 = OFF, 1 = ON
10	Valve Sequencing	0 = OFF, 1 = ON
11	LCD Contrast Pot	0 = Lightest, 255 = Darkest
12	SO2 Ref Zero Pot	S50 Reference zero pot

13	CO Input Pot	S30 Input pot
14	CO Reference Test Pot	Not Used
15	CO Test Measure Pot	Not Used
16	High Volt Adjust Pot	PMT High Voltage Adjust Pot for S50 & S40
17	SO2 Lamp Adjust Pot	S50 Lamp adjustment Pot
18	O3 Lamp Adjust Pot	S10 Lamp adjustment Pot
19	O3 Meas. Zero Pot (C)	S10 Signal zero measure (coarse)
20	O3 Meas. Zero Pot (F)	S10 Signal zero measure (fine)
21	PMT Fan Pot	Optical Bench fan speed control pot
22	Rear Fan Pot	Chassis Fan speed control pot
23	Pump Fine Pot	Internal Pump speed fine pot
24	Pump Coarse Pot	Internal Pump speed coarse pot
25	Analog input 0	SO2 Reference signal
26	Analog input 1	CO Reference signal
27	Analog input 2	O3 Reference signal
28	Analog input 3	SO2 & O3 Lamp current
29	Analog input 4	Flow block pressure
30	Analog input 5	Cell pressure
31	Analog input 6	Ambient pressure
32	Analog input 7	Raw ADC calibration input
33	Analog input 8	Reserved
34	Analog input 9	Concentration data
35	Analog input 10	Reserved
36	Analog input 11	Reserved
37	Analog input 12	Raw analog to digital count for external analog input 0. 0 - 5 V = 0 - 32766 A/D counts
38	Analog input 13	Raw analog to digital count for external analog input 1. 0 - 5 V = 0 - 32766 A/D counts
39	Analog input 14	Raw analog to digital count for external analog input 2. 0 - 5 V = 0 - 32766 A/D counts
40	Analog input 15	Reserved
41	CO Meas Zero Pot (C)	S30 Measure ZERO coarse adjustment Pot
42	CO Meas Zero Pot (F)	S30 Measure ZERO fine adjustment Pot
43	SO2 Input Pot	SO2 Measure Signal Gain Pot
44	SO2 Ref. Gain Pot	SO2 Reference Signal Gain Pot
45	SO2 Meas. Zero Pot	SO2 Measure zero pot
46	O3 Input Pot	O3 Input signal gain pot

47	Diagnostic Test Pot	The Diagnostic mode adjustment pot for all the analysers except for S30
48	NOx Input Pot	PMT signal input gain control FOR NOx
49	PGA Gain	1, 2, 4, 8, 16, 32, 64, 128
50	Gas 1 Inst.	Primary gas concentration currently displayed on the front screen E.g. NO
51	Gas 2 Inst.	Secondary gas concentration currently displayed on front screen E.g. NOx
52	Gas 3 Inst.	Calculated gas concentration currently displayed on front screen E.g. NO2
53	Gas 1 Avg.	Average of the readings (for Gas1) of the last n minutes where n is the averaging period
54	Gas 2 Avg.	Average of the readings (for Gas2) of the last n minutes where n is the averaging period
55	Gas 3 Avg.	Average of the readings (for Gas3) of the last n minutes where n is the averaging period
56	Instrument Gain	Current calibration value (default is 1.0)
57	Serial ID	Multidrop or Bayern-Hessen gas id
58	Bayern-Hessen ID	For multigas instruments only
59	Decimal Places	2 - 5
60	Noise	Instrument noise
61	Gas 1 Offset	An offset applied to Gas 1
62	Gas 3 Offset	An offset applied to Gas 3
63	Flow Temperature	Temperature of the flow block
64	Lamp Current	Lamp current in mA E.g 35mA
65	+5V Supply	Digital Supply voltage (should always read close to 5 volts)
66	Conc. Voltage	Concentration Voltage
67	High Voltage	High Voltage reading for PMT
68	Ozonator	0 = OFF, 1 = ON
69	Control Loop	0 = OFF, 1 = ON (default is ON)
70	Diagnostic Mode	0 = Operate 1 = Preamp 2 = Electrical 3 = Optical (default is Operate)
71	Gas Flow	Units in slpm
72	Gas Pressure	Units in torr
73	Ambient Pressure	Units in torr
74	+12V Supply	The 12 volt Power supply voltage

75	Cell Temperature	Cell Temperature																																		
76	Conv. Temperature	Converter Temperature																																		
77	Chassis Temperature	Chassis Temperature																																		
78	Manifold Temp.	Manifold Temperature																																		
79	Cooler Temperature	Cooler Temperature																																		
80	Mirror Temperature	Mirror Temperature																																		
81	Lamp Temperature	Lamp Temperature																																		
82	O3 Gen. Lamp Temp.	O3 Lamp Temperature																																		
83	Instrument Status	<p>Each bit in this 4-byte word represents a different condition (not all conditions apply to every instrument model):</p> <table border="1"> <thead> <tr> <th>BIT</th> <th>Condition if set</th> </tr> </thead> <tbody> <tr> <td>0</td> <td>Currently in warmup process</td> </tr> <tr> <td>1</td> <td>Volumetric units (ppm); otherwise gravimetric units (mg/m3)</td> </tr> <tr> <td>2</td> <td>Performing a background</td> </tr> <tr> <td>3</td> <td>Currently in Span mode</td> </tr> <tr> <td>4</td> <td>Currently in Zero mode</td> </tr> <tr> <td>5</td> <td>Instrument Out of Service (or in Diagnostic mode, PTF compensation or control loop disabled, or Comms debugging enabled)</td> </tr> <tr> <td>6</td> <td>High Voltage failure</td> </tr> <tr> <td>7</td> <td>System power failure (not actually possible to report)</td> </tr> <tr> <td>8</td> <td>Reference voltage failure</td> </tr> <tr> <td>9</td> <td>Cell temperature failure</td> </tr> <tr> <td>10</td> <td>Cooler failure</td> </tr> <tr> <td>11</td> <td>Converter failure</td> </tr> <tr> <td>12</td> <td>Correlation wheel failure</td> </tr> <tr> <td>13</td> <td>Lamp source failure</td> </tr> <tr> <td>14</td> <td>Flow fault</td> </tr> <tr> <td>15</td> <td>Any system error (the red instrument panel light is ON)</td> </tr> </tbody> </table>	BIT	Condition if set	0	Currently in warmup process	1	Volumetric units (ppm); otherwise gravimetric units (mg/m3)	2	Performing a background	3	Currently in Span mode	4	Currently in Zero mode	5	Instrument Out of Service (or in Diagnostic mode, PTF compensation or control loop disabled, or Comms debugging enabled)	6	High Voltage failure	7	System power failure (not actually possible to report)	8	Reference voltage failure	9	Cell temperature failure	10	Cooler failure	11	Converter failure	12	Correlation wheel failure	13	Lamp source failure	14	Flow fault	15	Any system error (the red instrument panel light is ON)
BIT	Condition if set																																			
0	Currently in warmup process																																			
1	Volumetric units (ppm); otherwise gravimetric units (mg/m3)																																			
2	Performing a background																																			
3	Currently in Span mode																																			
4	Currently in Zero mode																																			
5	Instrument Out of Service (or in Diagnostic mode, PTF compensation or control loop disabled, or Comms debugging enabled)																																			
6	High Voltage failure																																			
7	System power failure (not actually possible to report)																																			
8	Reference voltage failure																																			
9	Cell temperature failure																																			
10	Cooler failure																																			
11	Converter failure																																			
12	Correlation wheel failure																																			
13	Lamp source failure																																			
14	Flow fault																																			
15	Any system error (the red instrument panel light is ON)																																			
84	Reference Voltage	Units in Volts																																		
85	Calibration State	<p>This variable has two different sets of values:</p> <table border="1"> <thead> <tr> <th>Set Calibration State</th> <th>Get IEEE Value</th> </tr> </thead> <tbody> <tr> <td>0 = MEASURE</td> <td>0 = MEASURE</td> </tr> <tr> <td>1 = CYCLE</td> <td>1 = ZERO</td> </tr> <tr> <td>2 = ZERO</td> <td>2 = SPAN</td> </tr> </tbody> </table>	Set Calibration State	Get IEEE Value	0 = MEASURE	0 = MEASURE	1 = CYCLE	1 = ZERO	2 = ZERO	2 = SPAN																										
Set Calibration State	Get IEEE Value																																			
0 = MEASURE	0 = MEASURE																																			
1 = CYCLE	1 = ZERO																																			
2 = ZERO	2 = SPAN																																			

		3 = SPAN
86	Primary Raw Conc.	(For S40, before NOx background and gain)
87	Secondary Raw Conc.	Only for multigas instruments (For S40, before NOx background and gain)
88	S40 Backgnd Conc.	NOx Background Concentration (For S40, before gain)
89	Cal. Pressure	Calibration Pressure
90	Conv. Efficiency	Converter Efficiency
91	Multidrop Baud Rate	0 = 1200 bps 1 = 2400 bps 2 = 4800 bps 3 = 9600 bps 4 = 14400 bps 5 = 19200 bps 6 = 38400 bps
92	Anlg Range AO 0	Maximum range value for analog output
93	Anlg Range AO 1	
94	Anlg Range AO 2	
95	Output Type AO 0	Output Type
96	Output Type AO 1	1 = Voltage
97	Output Type AO 2	0 = Current
98	Anlg Ofst/Rng AO 0	Voltage Offset /Current Range
99	Anlg Ofst/Rng AO 1	0 = 0% or 0 - 20mA
100	Anlg Ofst/Rng AO 2	1 = 5% or 2 - 20mA 2 = 10% or 4 - 20mA
101	F/Scale Volt AO 0	5.0 Volt Calibration value
102	F/Scale Volt AO 1	
103	F/Scale Volt AO 2	
104	Z Adj Volt AO 0	0.5 Volt Calibration value
105	Z Adj Volt AO 1	
106	Z Adj Volt AO 2	
107	-Analog Supply	Negative analog supply
108	Digital Outputs	A single byte expressing the most recent state of the digital outputs
109	Digital Inputs	A single byte expressing the most recent state of the digital inputs
110	Instrument State	0 = Sample Fill 1 = Sample Measure 2 = Sample Fill Aux

		<p>3 = Sample Measure Aux 4 = Sample Fill Aux2 5 = Sample Measure Aux2 6 = Background Fill 7 = Background Measure 8 = Background Purge 9 = Background Fill Aux 10 = Background Measure Aux 11 = Zero Fill 12 = Zero Measure 13 = Zero Fill Aux 14 = Zero Measure Aux 15 = Zero Fill Aux2 16 = Measure Aux2 17 = Background Fill Zero 18 = Background Measure Zero 19 = Span Fill 20 = Span Measure 21 = Span Fill Aux 22 = Span Measure Aux 23 = Span Fill Aux2 24 = Span Measure Aux2 25 = Background Fill Span 26 = Background Measure Span 27 = Background Purge Span 28 = Electronic Zero Adjust 29 = Instrument Warm Up 30 = Background Adjust Fill 31 = Background Adjust Measure</p>
111	CO Lin. Factor A	CO Linearisation Factor A
112	CO Lin. Factor B	CO Linearisation Factor B
113	CO Lin. Factor C	CO Linearisation Factor C
114	CO Lin. Factor D	CO Linearisation Factor D
115	CO Lin. Factor E	CO Linearisation Factor E
116	Instrument Units	<p>0 = ppm 1 = ppb 2 = ppt 3 = mg/m³ 4 = µg/m³ 5 = ng/m³ 6 = %</p>
117	Backgnd Meas. Time	In seconds.

118	Sample Fill Time	These parameters can be changed, but only temporarily; restarting the instrument will restore them to their default values.
119	Sample Measure Time	
120	Aux Measure Time	
121	Aux Smpl. Fill Time	
122	Backgnd Fill Time	
123	Zero Fill Time	
124	Zero Measure Time	
125	Span Fill Time	
126	Span Measure Time	
127	O3 Gen. Coeff D	O3 Generator Coefficient D
128	Backgnd Pause Time	In seconds
129	Bkgnd Intrleav Fact	
130	Cal. Pressure 2	Calibration Pressure for 2nd gas
131	2nd Instrument Gain	Only valid with an S40 variant set to multiple gains. Shows the second gas gain (NO). Default is 1.0.
132	Background voltage	Units in Volts
133	Perm Rate	Permeation rate of the gas in ng/min
134	Perm Flow	Total flow past the permeation chamber during an activated internal span mode. In ml/min
135	Perm Oven Setpoint	Set target temperature for the permeation oven. Default is 50°C
136	Perm Oven Temp	Temperature readout of the Permeation oven. Units in °C
137	Ozone Target	Ozone Target for S10 IZS Ozone generation
138	Conc Adjusted 1	Concentration value in PPM before filtering
139	Conc Adjusted 2	
140	Conc Adjusted 3	
141	Chopper Speed	Revolutions in the last second
142	Chopper Frequency	In rpm
143	IR Source	The S30 IR source voltage
144	Background (hrs)	The background interval in hours. 0.0 if disabled 0.25 for every 15 minutes 0.30 for every 20 minutes 0.50 for every 30 minutes 1.00 for every hour 24.00 for once a day
145	Cycle Time	In minutes
146	CO Cooler Pot	CO Cooler voltage adjustment POT

147	CO Source Pot	CO Source voltage adjustment POT
148	CO Test Meas. Pot	Diagnostics use only
149	CO Test Ref. Pot	Diagnostics use only
150	O3 Ref Average	S10 Background Average
151	PTF Correction (gas 1)	Pressure Temperature Flow Compensation Factor for first gas
152	PTF Correction (gas 2)	Pressure Temperature Flow Compensation Factor for second gas in dual gas analysers.
153	Inst. Cell Pressure	Instantaneous cell pressure
154	Manifold Pressure	Manifold Pressure in S40 instruments
155	Cell Press. (gas 1)	Cell Pressure for Gas 1
156	Cell Press. (gas 2)	Cell Pressure for Gas 2
157	Cell Press. (Bgnd)	Cell Pressure when in Background
158	Background	0 = the instrument is measuring a gas sample 1 = the instrument is measuring background air
159	Gas To Measure	S51 only; see Measurement Settings Menu 0 = Measure both gasses 1 = Measure SO2 only 2 = Measure H2S only
160	Valve States	Diagnostic use only
161	Temperature Units	0 = "°C" 1 = "°F" 2 = "K"
162	Pressure Units	0 = "torr" 1 = "psi" 2 = "mbar" 3 = "atm" 4 = "kPa"
163	Averaging Period	0 = "1 Min" 1 = "3 Mins" 2 = "5 Mins" 3 = "10 Mins" 4 = "15 Mins" 5 = "30 Mins" 6 = "1 Hr" 7 = "4 Hrs" 8 = "8 Hrs" 9 = "12 Hrs" 10 = "24 Hrs" Added as of V 3.57.001 11 = "4 hrs/hr" 12 = "8 hrs/hr"

		<p>Added as of Build 10800 (V3.87.0 or later)</p> <p>13 = "2 Mins"</p> <p>14 = "4 Mins"</p> <p>15 = "6 Mins"</p> <p>16 = "12 Mins"</p> <p>17 = "20 Mins"</p> <p>18 = "2 Hrs"</p> <p>19 = "6 Hrs"</p>
164	Filter Type	<p>0 = NO FILTER</p> <p>1 = KALMAN FILTER</p> <p>2 = 10 SEC FILTER</p> <p>3 = 30 SEC FILTER</p> <p>4 = 60 SEC FILTER</p> <p>5 = 90 SEC FILTER</p> <p>6 = 300 SEC FILTER</p> <p>7 = ADPTIVE FILTER</p>
165	NO2 Filter enabled	0 = Disabled, 1 = Enabled
166	Background Interval	<p>0 = 24 Hrs</p> <p>1 = 12 Hrs</p> <p>2 = 8 Hrs</p> <p>3 = 6 Hrs</p> <p>4 = 4 Hrs</p> <p>5 = 2 Hrs</p> <p>6 = Disable</p> <p>Note: this parameter is deprecated; while it can still be read, writing to it will have no effect. Use parameter 144 instead.</p>
167	Service (COM1) Baud	Serial baud rate
168	Multidrop (COM2) Baud	<p>0 = 1200 bps</p> <p>1 = 2400 bps</p> <p>2 = 4800 bps</p> <p>3 = 9600 bps</p> <p>4 = 14400 bps</p> <p>5 = 19200 bps</p> <p>6 = 38400 bps</p>
169	Service Protocol	0 = EC9800
170	Multidrop Protocol	<p>1 = Bayern-Hessen</p> <p>2 = Advanced</p> <p>3 = Modbus</p>
171	AO1 Over Range	The Upper Concentration Range when Over-Ranging is enabled
172	AO2 Over Range	
173	AO3 Over Range	
174	AO1 Over-Ranging	0 = Over Ranging Disabled

175	AO2 Over-Ranging	1 = Over Ranging Enabled
176	AO3 Over-Ranging	2 = Over Ranging enabled and currently active
177	Heater Set Point	Cell Heater Set Point units in °C
178	High Volt Adjust Pot	High voltage pot setting
179	PMT Test LED Pot	PMT Test LED intensity controller POT
180	Last Power Failure	Time Stamp of the Last power fail (4 byte time stamp) Bit 31:26 ---- Year (0 – 99) Bit 25:22 ---- Month (1 – 12) Bit 21:17 ---- Date (1 – 31) Bit 16:12 ---- Hour (00 – 23) Bit 11:06 ---- Min (00 – 59) Bit 05:00 ---- Sec (00 – 59)
181	Inst Manifold Press.	Manifold Pressure in S40 instruments (instantaneous)
182	Cell Press. (Gas 5)	Cell Pressure for Gas 5 (Nx)
183	Gas 4 Inst.	Calculated gas concentration currently displayed on front screen E.g. NH3
184	Gas 4 Avg.	Average of the readings (for Gas 4) of the last n minutes where n is the averaging period E.g. NH3
185	Gas 5 Inst.	Calculated gas concentration currently displayed on front screen E.g. Nx
186	NH3 Conv. Efficiency	
187	Cell/Lamp Duty Cycle	
188	Mirror T. Duty Cycle	
189	Flow Temp Duty Cycle	
190	Cooler T. Duty Cycle	
191	Conv Temp Duty Cycle	
192	CO Conv T Duty Cycle	
193	F/Scale Curr AO 0	20 mA Calibration value
194	F/Scale Curr AO 1	
195	F/Scale Curr AO 2	
196	Z Adj Curr AO 0	4 mA Calibration value
197	Z Adj Curr AO 1	
198	Z Adj Curr AO 2	
199	Ext Analog Input 0	The value of the external analog input after the multiplier and offset have been applied
200	Ext Analog Input 1	
201	Ext Analog Input 2	
202	Conv Set Point	Converter Set Point
203	Cal. Pressure 3	Calibration Pressure 3

204	PTF Correction (gas 3)	Pressure Temperature Flow Compensation Factor for third gas in multi-gas instruments.
205	Dilution Ratio	The current dilution ratio (default is 1.0)
206	Traffic Light	State of the status light: 0 = Green 1 = Amber 2 = OFF (normally impossible) 3 = Red
207	Network Protocol	0 = EC9800 1 = Bayern-Hessen 2 = Advanced 3 = Modbus
208	Gas 4 Offset	An offset applied to Gas 4
209	O3 Gen. Fine Pot	Ozone generator control, DAC controlled. DAC: 0..64535
210	O3 Gen. Lamp Current	Units in mA
211	O3 Gen. Coarse Pot	Repeat of parameter 209
212	Logging Period	The data logging period, in seconds (1.. 86400)
213	O3 Gen. Coeff A	Ozone generator coefficients
214	O3 Gen. Coeff B	Note that Coeff D is parameter 127
215	O3 Gen. Coeff C	
216	Meas. Count	S60 measure count
217	Sig. Count 1	S60 signal counts
218	Sig. Count 2	
219	Sig. Count 3	
220	Sig. Count 4	
221	Signal Voltage	S60 signal voltage
222	LED Drive	S60 LED drive value
223	3rd Instrument Gain	Only valid with an S44 variant set to multiple gains. Shows the third gas gain (Nx). Default is 1.0.
224	Legacy PTF Method	Only applies to S40 variants. 0 = new PTF calculation 1 = old PTF calculation inherited from ML This value was added to Build 10800 and defaults to 1.
225	Chassis Humidity	Only applies to S30 variants, and only on Rev P or later boards. The current humidity inside the instrument, in percentage.
226	Opto. Strength	Only applies to Rev P or later boards. Optical signal strength.

Appendix B. EC9800 Protocol

The Serinus implements a subset of the 9800 instrument protocol. Only the basic commands of reading the concentration value and setting the instrument calibration state (measure, span or zero) are supported.

B.1 Command Format

All commands are sent as ASCII strings. Fields are delimited by commas and the command ends with the normal return key (i.e. the TERMINATOR is either a <CR> or a <LF>). The DEVICE I.D. is the Serial ID assigned in the **Main Menu** → **Communications Menu** → **Serial Communication Menu**. If the instrument is not being used in a multi-drop connection, the DEVICE I.D. can be replaced with the string “???”.

B.2 Commands

DCONC

Function: Sends the current instantaneous concentration data to the serial port.

Format: DCONC, {<DEVICE I.D.>} {TERMINATOR}

Device response: {GAS} <SPACE> {STATUS WORD} <CR><LF>

The GAS value is the concentration value in the current instrument units, expressed as a floating point number (i.e. 12.345). The STATUS WORD indicates the instrument status in hex (i.e. A01F) using the following format:

Bit 15 = SYSFAIL (MSB)

Bit 14 = FLOWFAIL

Bit 13 = LAMPFAIL

Bit 12 = CHOPFAIL

Bit 11 = CVFAIL

Bit 10 = COOLERFAIL

Bit 9 = HEATERFAIL

Bit 8 = REFFAIL

Bit 7 = PS-FAIL

Bit 6 = HV-FAIL

Bit 5 = OUT OF SERVICE

Bit 4 = Instrument is in zero mode

Bit 3 = Instrument is in span mode

Bit 2 = Unused

Bit 1 = SET→PPM selected, CLEAR→MG/M3

Bit 0 = reserved (LSB)

DSPAN

Function: Commands the instrument to enter span mode.

Format: DSPAN, {<DEVICE I.D.>} {TERMINATOR}

Device response: <ACK> if the instrument is able to perform the command, <NAK> if not.

DZERO

Function: Commands the instrument to enter the zero mode.

Format: DZERO, {<DEVICE I.D.>} {TERMINATOR}

Device response: <ACK> if the instrument is able to perform the command, <NAK> if not.

ABORT

Function: Commands the instrument to abort the current span/zero mode and return to measure mode.

Format: ABORT, {<DEVICE I.D.>} {TERMINATOR}

Device response: <ACK> if the instrument is able to perform the command, <NAK> if not.

RESET

Function: Reboots the instrument (software reset).

Format: RESET, {<DEVICE I.D.>} {TERMINATOR}

Device response: <ACK>.

Appendix C. Bayern-Hessen Protocol

The Serinus implements a limited subset of the Bayern-Hessen Network protocol. Only the ability to set the instrument calibration state (measure, span or zero) and read the gas concentrations are supported.

C.1 Command Format

<STX><text><ETX>< bcc1><bcc2>

Where:

- <STX> ASCII Start of Text = 0x02 hex.
- <Text> ASCII text maximum length of 160 characters.
- <ETX> ASCII End of Text = 0x03 hex.
- <bcc1> ASCII representation of block check value MSB. (That is, the character “3” for 3, the character “F” for 15, etc.)
- <bcc2> ASCII representation of block check value LSB.

The block check algorithm begins with 0 and exclusive-OR’s each ASCII character from <STX> to <ETX> inclusive. This block check value is converted to ASCII format and sent after the <ETX> character.

Examples

This is an example of a valid Bayern-Hessen data request for an instrument that has a Serial ID of 97 (Serial ID assigned in the **Main Menu** → **Communications Menu** → **Serial Communication Menu**):

<STX>DA097<ETX>3A

The block check calculation is best shown by the following example:

Table 34 – Bayern-Hessen Data

Character	Hex Value	Binary	Block Check
<STX>	02	0000 0010	0000 0010
D	44	0100 0100	0100 0110
A	41	0100 0001	0000 0111
0	30	0011 0000	0011 0111
9	39	0011 1001	0000 1110
7	37	0011 0111	0011 1001
<ETX>	03	0000 0011	0011 1010

The binary value 0011 1010 corresponds to the hex value 3A. This value in ASCII forms the last two characters of the data request message.

Note: The I.D. of 97 is sent as the sequence 097. All I.D. strings must have three digits and must always be padded with ASCII zero characters.

This is an example of a valid command to put the unit in the manual span mode if the instrument has an ID of 843:

```
<STX>ST843 K<ETX>52
```

The block check operation is best shown with the following table:

Table 35 – Block Check Operation

Character	Hex Value	Binary	Block Check
<STX>	02	0000 0010	0000 0010
S	53	0101 0011	0101 0001
T	54	0101 0100	0000 0101
8	38	0011 1000	0011 1101
4	34	0011 0100	0000 1001
3	33	0011 0011	0011 1010
<SPACE>	20	0010 0000	0001 1010
K	4B	0100 1011	0101 0001
<ETX>	03	0000 0011	0101 0010

The binary block check value is 0101 0010 which is the hex value 52 as shown at the end of the command string.

C.2 Commands

DA

Return the current instantaneous concentration.

Command Format

```
<STX>{DA}{<kkk>}<ETX>< bcc1><bcc2>
```

Where:

kkk Device's ID. This field is optional, but if provided it must be padded with zeros to be 3 characters long. The value must match one of the following: the instrument's Bayern-Hessen ID, 000, or ??? (three question marks).

bcc1 First byte of the block check calculation.

bcc2 Second byte of the block check calculation.

Device response

The instrument responds with a variable length string, depending on how many measured gasses have been assigned an ID above 0. The text between the [] will be repeated once for each reported gas.

```
<STX>{MD}{cc}[<SP><kkk><SP><+nnnn+ee><SP><ss><SP><ff><SP><mmm><SP>eeeeee<SP>]<ETC><
bcc1><bcc2>
```

Where:

<SP>	Space (0x20 hex).
cc	The number of gasses reported (0..5). The text in between the [] will be repeated once for each gas reported.
kkk	The Bayern-Hessen instrument ID.
+nnnn+ee	Gas concentration.
ss	Status byte (see table below for individual bits).
ff	Failure byte (see table below for individual bits).
mmm	Gas ID.
eeeeee	Ecotech instrument ID.
bcc1	First byte of the block check calculation.
bcc2	Second byte of the block check calculation.

Table 36 – Status Bit Map

Status Bit	Meaning if set to 1
0	Instrument OFF (this value is always set to 0).
1	Out of service.
2	Zero mode.
3	Span mode.
4	-
5	-
6	Units: 1 = Volumetric, 0 = Gravimetric.
7	Background mode (S30 and S50 family only).

Table 37 – Failure Bit Map (Positive Logic)

Failure Bit	Meaning if set to 1
0	Flow sensor failure.
1	Instrument failure. Note that while the In Maintenance mode reports as an instrument failure with a red light on the front panel, for Bayern-Hessen this particular error is merely a status instead of a failure.
2	-
3	Lamp failure (S40 family only).
4	-
5	Cell heater failure (S30, S40 and S50 family only).
6	-
7	-

ST

Set the instrument mode.

Command Format

<STX>{ST}{< kkk>}<SP>{command}<ETC><bcc1><bcc2>

Where:

- kkk Device’s Serial ID. This field is optional, but if provided it must be padded with zeros to be 3 characters long. The value must match one of the following: the instrument’s Bayern-Hessen ID, 000, or ??? (three question marks).
- Command M, N or K for Measure, Zero or Span mode.
- bcc1 First byte of the block check calculation.
- bcc2 Second byte of the block check calculation.

Device response

The device does not issue a response to this command.

Appendix D. ModBus Protocol

The Serinus supports a limited Modbus implementation. The only function codes supported are 3 (read holding register) and 16 (write multiple registers). The Serial ID is assigned in the **Main Menu → Communications Menu → Serial Communication Menu**.

D.1 Command Format

<Slave address><Function code><Start register (MSB)><Start register (LSB)><Register count (MSB)><Register count (LSB)><Write byte count><Write data><CRC (MSB)><CRC (LSB)>

Where:

Slave address	The instrument Serial ID. If the request is being made via TCP, this field is omitted.
Function code	3 (read) or 16 (write).
Start register	Specifies an Advanced Protocol IEEE index (refer to Table 33 to see what values are available and what index to specify for them). The ModBus index is calculated from the Advanced Protocol index via the following formula: $\text{Modbus Index} = \text{Advanced Protocol Parameter List number} \times 2 + 256$
Register count	A single read command may request from 2 - 124 registers, which is to say from 1 - 62 values. The first index is specified by Start register; all following indexes are in sequential order. To read values that are not sequential requires using another read command. Note that the number of registers must be even, as each value is returned as a floating point value (4 bytes) and each register is a word (2 bytes). A write command can only write a single IEEE value at a time. Thus for write commands this value must be 2.
Write byte count	This field is only supplied for a write request; it indicates the amount of bytes of data that will follow, and must be set to 4 (since only one value can be written at a time).
Write data	This field is only supplied for a write request. It is the value to be written, expressed in IEEE format. The "Endian" structure can be selected on the Modbus Serial Communications menu. Big Endian means that the MSB byte of the IEEE value is at the right end of the four bytes; Little Endian means it is at the left.
CRC	Calculated by the standard Modbus CRC method. If the request is being made via TCP, this field is omitted.

D.2 Commands

Read Holding Registers

The response to a read request is in the following format:

<Slave address>3<Register count (MSB)><Register count (LSB)><Data><CRC (MSB)><CRC (LSB)>

Where:

Slave address	As general command format.
Register count	As general command format.
Data	4 - 248 bytes of data, representing 1 - 62 floating point numbers in IEEE format. The “Endian” structure can be selected on the Modbus Serial Communications menu. Big Endian means that the MSB byte of the IEEE value is at the right end of the four bytes; Little Endian means it is at the left.
CRC	As general command format.

Write Holding Register

The only supported use for this command is to set the instrument into a calibration state.

Where:

Start register MSB	1
Start register LSB	170
Register count	2
Write Data bytes	The IEEE representation of 0, 1, 2, or 3 0 puts the instrument into Measure mode (0,0,0,0) 1 puts the instrument into Cycle mode (63,128,0,0) 2 puts the instrument into Zero mode (64,0,0,0) 3 puts the instrument into Span mode (64,64,0,0)

The response to a write request is to return the first six bytes of the initiating write request.

Error

An error will be returned in the following format:

<Slave address><Function code><Exception code><CRC (MSB)><CRC (LSB)>

Slave address	As general command format.
Function code	The initiating command’s function code + 128; so either 131 (read) or 144 (write).
Exception code	The error code (see table below).

CRC As general command format.

Table 38 – Modbus Error Codes

Value	Error
1	Illegal Function
2	Illegal Data Address
3	Illegal Data Value
4	Slave Device Failure



acoem.com

User manual subject to change without notice. Images used are for illustrative purposes only.
All trademarks and registered trademarks are the property of their respective owners.
© 2022 Acoem and all related entities. All rights reserved.